

স্পেশালাইজড্ হাই স্কুলস্ অ্যাডমিশন্স টেস্ট - SHSAT-এর NYC গাইড 2023-এ ভর্তির জন্য

এই গাইডে দেয়া তথ্য প্রকাশনার সময় পর্যন্ত সঠিক রয়েছে কিন্তু পরিবর্তিত হতে পারে। ভর্তি, অনুষ্ঠানাদি, স্কুল, এবং প্রোগ্রাম সম্পর্কিত সর্ব-সাম্প্রতিক তথ্যের জন্য schools.nyc.gov/SHS, schools.nyc.gov/High, এবং MySchools.nyc দেখুন।

নিউ ইয়র্ক সিটি ডিপার্টমেন্ট অফ এডুকেশনের নীতি হচ্ছে প্রকৃত অথবা ধারণাকৃত জাতি, বর্ণ, ধর্ম, কৃষ্টি, জাতিগত পরিচয়, রাষ্ট্রিক পরিচয়, অভিবাসনগত অবস্থা, নাগরিকত্বের অবস্থা, প্রতিবন্ধিতা, যৌন পক্ষপাত, লিঙ্গ (লিঙ্গ পরিচয়) বা ওজনের ভিত্তিতে বৈষম্য না করে সম শিক্ষা সুযোগ প্রদান এবং যৌন হয়রানি বা প্রতিশোধমূলক হয়রানি মুক্ত একটি পরিবেশ বজায় রাখা। যথাযথ আইনের প্রতিপালন সংক্রান্ত অনুসন্ধান পাঠাতে হবে নিচের ঠিকানায়:
Director, Office of Educational Opportunity, 65 Court Street, Room 1102, Brooklyn,
New York 11201. টেলিফোন 718-935-3320 / টোল-ফ্রি: 877-332-4845।

বিষয়সূচি

1.0 SHSAT দায়ের প্রস্তুতগ্ৰহণ করুন	4
1.1 কী আশা করতে পারেন তা জানুন.....	4
1.2 অনুশীলনী পরীক্ষা (প্র্যাকটিস টেস্ট) দিনি.....	4
1.3 নমুনা পরীক্ষার আপনার উত্তরগুলো যাচাই করুন.....	5
1.4 ইংলিশ ল্যাঙগুয়েজে আর্টস সেকেশনরে জন্য কীভাবে প্রস্তুত হতে হবে.....	6
1.5 গণতি (ম্যাথ) সেকেশনরে জন্য কীভাবে প্রস্তুত হতে হবে.....	18
2.0 পরীক্ষা দিনরে জন্য প্রস্তুত হোন	30
2.1 আপনাকে পরীক্ষার অধবিশেনে কী কী আনতে হবে.....	30
2.2 কী কী আনা যাবে না.....	30
2.3 পরীক্ষা দিনরে প্রত্যাশা.....	31
2.4 উত্তর-পত্র বা অ্যানসার শীট পূরণকরণ.....	31
2.5 শক্কার্থীর অসদাচরণ.....	32
3.0 আমি SHSAT পরীক্ষা দায়ের পর কী হবে?	33
3.1 পরীক্ষায় অনয়িমরে অভযিোগ.....	33

SAMPLE TEST A	34
General Directions	34
Sample Test	36
Form A Sample Test – English Language Arts Explanations of Correct Answers	98
Form A Sample Test – Mathematics Explanations of Correct Answers	128
Form A Sample Test – Answer Key	153
SAMPLE TEST B	154
General Directions	154
Sample Test	156
Form B Sample Test – English Language Arts Explanations of Correct Answers	214
Form B Sample Test – Mathematics Explanations of Correct Answers	248
Form B Sample Test – Answer Key	270
Grade 9 Mathematics Sample Questions	271
Grade 9 Mathematics Explanations of Correct Answers	275
Grade 8 Grid-In Sample Problems	280
Grade 8 Grid-In Explanations of Correct Answers	283
SHSAT Sample Answer Sheets	290
SHSAT Blank Grid-ins to be Used with Sample Items	292

1.0 SHSAT দেয়ার প্রস্তুতি গ্রহণ করুন

শিক্ষার্থীরা যেন পরীক্ষার জন্য ভালভাবে প্রস্তুত হতে পারে সেজন্য পরিবারদের এই সেকশনটি তাদের সন্তানের সাথে একসঙ্গে পর্যালোচনা করা উচিত।

1.1 কী আশা করতে পারেন তা জানুন

- এই হ্যান্ডবুকের নিম্নলিখিত বিষয়গুলো পর্যালোচনা করে পরীক্ষার ধারা কেমন হবে সে সম্পর্কে ভালভাবে পরিচিত হোন:
 - পরীক্ষাটির বর্ণনা
 - দুইটি পূর্ণ দৈর্ঘ্য পরীক্ষার নমুনা
 - প্রতিটি পরীক্ষার নমুনার উত্তর পত্র (অ্যানসার কী) এবং ব্যাখ্যাসমূহ
 - ম্যাথ গ্রিড-ইন (grid-in) প্রশ্নাবলীর জন্য অতিরিক্ত নমুনাসমূহ
 - নবম (9) গ্রেডের সুনির্দিষ্ট প্রশ্নের নমুনা (যদি আপনি নবম গ্রেডের শিক্ষার্থী হিসেবে পরীক্ষা দেয়ার পরিকল্পনা করে থাকেন)
- নমুনাগুলোর সাথে ভালভাবে পরিচিত হোন।
 - ELA নমুনাগুলো 7 নম্বর পৃষ্ঠা থেকে শুরু হয়েছে।
 - গণিতের (ম্যাথ) নমুনাগুলো 20 নম্বর পৃষ্ঠা থেকে শুরু হয়েছে।
- প্রতিটি সেকশনের নির্দেশনার সাথে ভালভাবে পরিচিত হোন, যেন আপনি:
 - পুরোপুরিভাবে বুঝতে পারেন পরীক্ষার কোন্ অংশে কী করতে হবে: A & B অংশ পুন:পাঠ করা/সম্পাদনা (রিভাইজিং/এডিটিং), রিডিং কম্প্রিহেনশন, ম্যাথ grid-Ins, এবং ম্যাথ মাল্টিপল-চয়েস
 - পরীক্ষার দিন নির্দেশনা পড়ার মাধ্যমে আপনার সময় নষ্ট করার পরিবর্তে প্রশ্নের উত্তর দেয়ায় মনোনিবেশ করতে পারেন
- অনুশীলনী পরীক্ষার সাথে দেয়া উত্তর পত্র বা অ্যানসার শীটের সাথে ভালভাবে পরিচিত হোন, যেন আপনি:
 - পরীক্ষার দিন, পরীক্ষা শুরু করার আগে আপনার নাম, গ্রেড স্তর (লেভেল), এবং জন্মতারিখ সহজভাবে লিখতে পারেন
 - পরীক্ষার দিন, পরীক্ষা শুরু হওয়ার সাথে সাথে যেন আপনি সহজে, সঠিকভাবে, এবং তাড়াতাড়ি উত্তরগুলো চিহ্নিত করতে পারেন

1.2 অনুশীলনী পরীক্ষা (প্র্যাকটিস টেস্ট) দিন

- একটি পরিকল্পনা তৈরি করুন।
 - এই প্যাকেটে দুইটি পরীক্ষার নমুনা দেয়া আছে, এবং আপনি এগুলো যেভাবে খুশি ব্যবহার করতে পারেন; নির্দিষ্ট সময়ের মধ্যে অন্তত একটি পরীক্ষা অনুশীলন করতে আপনাকে উৎসাহিত করা হচ্ছে।
 - পরীক্ষাটি সম্পন্ন করার জন্য আপনি 180 মিনিট সময় পাবেন; যোগ্য ইংলিশ ল্যাঙ্গুয়েজ লার্নার্স অথবা যেসব শিক্ষার্থীকে পরীক্ষায় বিশেষ সুবিধা হিসেবে অতিরিক্ত সময় দেয়া হবে, তারা পরীক্ষাটি শেষ করতে 360 মিনিট সময় পাবে।
 - আপনি যেকোনো অংশ দিয়ে পরীক্ষা শুরু করতে পারেন, সুতরাং পরীক্ষার দিন কোন্ অংশের পর কোন্ অংশ করবেন তা আগে থেকেই সিদ্ধান্ত নিন।
 - আপনি ELA এবং ম্যাথের মধ্যে যেভাবে খুশি সময় ভাগ করে নিতে পারেন।
- নমুনা SHSAT উত্তর পত্র বা অ্যানসার শীট প্রিন্ট করে নিন
- আপনি হাতঘড়ি অথবা দেয়ালঘড়ি ব্যবহার করে আপনার পরীক্ষার সময় - 180 মিনিটের প্রতি লক্ষ্য রাখুন।
- ELA অথবা ম্যাথ, যেকোনো সেকশনের প্রশ্নের উত্তর দেয়া শুরু করুন।
 - মনে রাখবেন, কোন্ সেকশন আপনি আগে করবেন সেটা আপনার ইচ্ছা!

- সতর্কতার সাথে উত্তর দিন, কিন্তু স্বাচ্ছন্দ্য গতিতে এগিয়ে যান।
 - কোনো প্রশ্নের পিছে দুই মিনিটের বেশী ব্যয় করবেন না।
- প্রশ্নের উত্তর দেয়ার জন্য উত্তর পত্র বা অ্যানসার শীটে আপনার উত্তরের বৃত্তগুলো ভরাট (বাবল) করুন।
- উত্তরের বৃত্তগুলো পুরোপুরি ভরাট করতে হবে।

উত্তর চিহ্নিত করার নমুনা				
(A)	(B)	(C)	●	সঠিক
⊗	(B)	(C)	(D)	ভুল
(A)	⊗	(C)	(D)	ভুল
(A)	(B)	●	(D)	ভুল
(A)	(B)	●	●	ভুল

- সময় শেষ, ঘোষণাটি দেয়ার আগে সব উত্তর অবশ্যই লিপিবদ্ধ করতে হবে।
মনে রাখবেন: উত্তরপত্রে উত্তর দেয়ার জন্য আপনাকে অতিরিক্ত সময় দেয়া হবে না।
- আপনার জ্ঞান অনুযায়ী করা অনুমান সঠিক হতে পারে।
- যে উত্তর(গুলি) নিশ্চিতভাবে ভুল সেগুলি বাদ দিন এবং তারপর অবশিষ্ট উত্তরগুলো থেকে একটি বেছে নিন।
 - উত্তর পত্রে কতগুলো চিহ্নিত উত্তর সঠিক হয়েছে সেটার উপর নির্ভর করে আপনার স্কোর নির্ধারিত হয়। যেহেতু ভুল উত্তরের জন্য কোনো নম্বর কাটা হবে না, তাই কোনো প্রশ্ন বাদ দিয়ে গেলে আপনার কোনো লাভ হচ্ছে না।
- যদি সময় অবশিষ্ট থাকে তবে আপনার উত্তরগুলো আবার দেখুন।
- সময় শেষ হওয়ার আগেই যদি আপনার পরীক্ষা দেয়া শেষ হয়ে যায়, আপনার উত্তরগুলো আবার দেখুন যেন আপনি সঠিকভাবে নির্দেশনা অনুসরণ করেছেন, কোনও প্রশ্নের উত্তর বাদ পড়ে যায়নি, এবং অসাবধান বশতঃ কোনো ভুল করেননি। মনে রাখবেন: ভুল উত্তরের জন্য নম্বর কাটা হবে না, সুতরাং কোনো প্রশ্ন যেন বাদ না পড়ে যায় তা নিশ্চিত করুন!
 - লক্ষ্য রাখবেন যে, পরীক্ষার দিন, আপনাকে পরীক্ষার কক্ষে পরীক্ষার পুরো সময়টুকু (180 মিনিট) বসে থাকতে হবে।

1.3 নমুনা পরীক্ষার আপনার উত্তরগুলো যাচাই করুন

- আপনার নমুনা পরীক্ষা শেষ হয়ে যাবার পর, আপনার উত্তরগুলো সঠিক উত্তরের তালিকার সাথে মিলিয়ে দেখুন।
- আপনি যদি ভুল করে থাকেন তবে কী ধরনের ভুল করে থাকতে পারেন তা দেখতে সঠিক উত্তরের ব্যাখ্যাটি পড়ুন।
 - আপনার ভুলগুলোর মধ্যে কোনো প্যাটার্ন রয়েছে কিনা তা পরীক্ষা করে দেখুন।
 - **ELA উদাহরণ:** প্রধান বিষয় অথবা লেখকের উদ্দেশ্য সম্পর্কিত কোনো প্রশ্ন আপনি বাদ দিয়েছেন কি?
 - **ম্যাথ উদাহরণ:** গণনায় ভুলের কারণে আপনি অনেকগুলি প্রশ্ন বাদ দিয়েছেন কি?
 - যে বিষয়গুলো আপনার জন্য চ্যালেঞ্জপূর্ণ সেগুলো আরো অনুশীলন করার সুযোগ খুঁজে বের করুন!

1.4 ইংলিশ ল্যাঙ্গুয়েজ আর্টস সেকশনের জন্য কীভাবে প্রস্তুত হতে হবে

ইংলিশ ল্যাঙ্গুয়েজ আর্টস সেকশনে 57টি মাল্টিপল চয়েস (বহু বিকল্প থেকে সঠিক উত্তর বাছাই) প্রশ্ন থাকে, যেগুলো পর্যালোচনা/সম্পাদনার (রিভাইস/এডিট) দক্ষতা ও রিডিং কম্প্রিহেনশন মূল্যায়ন করে। এই প্রশ্নগুলি নিউ ইয়র্ক স্টেটের শিক্ষণ মানদণ্ডের সাথে সমন্বিত। পরবর্তী পৃষ্ঠাগুলিতে পর্যালোচনা/সম্পাদনার (রিভাইস/এডিট) এবং রিডিং কম্প্রিহেনশন প্রশ্নের উত্তর দেয়া সম্পর্কে কিছু পরামর্শ আছে।

পর্যালোচনা/সম্পাদনার (রিভাইস/এডিট) উপরিচিত্র পার্ট A

এই সেকশনে যে ভাষা দক্ষতা মূল্যায়ন করা হয় তা নির্ভর করে নিউ ইয়র্ক স্টেটের শিক্ষণ মানদণ্ডের সপ্তম (7) গ্রেডের ল্যাঙ্গুয়েজ সেকশনের উপর, এবং এর পাশাপাশি পূর্বের গ্রেডগুলিতে অর্জিত দক্ষতা বা মানের উপর, উদাহরণস্বরূপ ল্যাঙ্গুয়েজ প্রোগ্রেসিভ স্কিলস। প্রতিটি প্রশ্ন আপনাকে একটি বাক্য, বাক্যসমূহের একটি তালিকা, অথবা নম্বরযুক্ত বাক্যসমষ্টির প্যারাগ্রাফ পড়ার প্রতি নির্দেশনা প্রদান করে। তারপর আপনাকে ভাষার নিয়ম-কানুন অথবা যতিচিহ্ন (পাংচুয়েশন) সম্পর্কিত সমস্যা সমাধান করতে বলা হয়। উদাহরণে অন্তর্ভুক্ত:

- কোনো ভুলের জন্য সর্বোচ্চ সঠিক উত্তরটি বেছে নেয়া
- ভুল আছে এমন একটি বাক্য শনাক্ত করা
- লেখাটির উন্নতিকল্পে বাক্যসমূহ সংযুক্ত করা অথবা বাক্যের কোনো অংশ সংশোধন করা



পর্যালোচনা/সম্পাদনার (রিভাইস/এডিট) জন্য পরামর্শসমূহ পার্ট A

প্রথমে, প্রশ্নটি পড়ুন।

- অধিকাংশ বিষয়ের ক্ষেত্রে, টেক্সট পড়ার আগে প্রথমে প্রশ্নটি পড়ুন যেন আপনি বুঝতে পারেন টেক্সট পড়ার সময় আপনাকে কোন্ ধরনের বিষয়ের প্রতি খেয়াল রাখতে হবে।

এরপর, সময়ের প্রতি লক্ষ্য রেখে, বক্রে দেয়া টেক্সটটি পড়ুন এবং কোন্ বিষয়টির প্রতি আপনি লক্ষ্য রাখছেন তা নোট করুন।

- ভাষার ব্যবহারে অথবা যতিচিহ্নের ভুলের কারণে কোনো শব্দ, বাক্যাংশ, অথবা বাক্য পড়া কষ্টসাধ্য হচ্ছে কি?
- টেক্সটের এমন কোনো অংশ আছে কি যা আরও স্পষ্টভাবে, সংক্ষেপে, অথবা যথাযথভাবে লেখা যেত?
- যখন কোনো সমস্যা লক্ষ্য করবেন, দ্রুত টেক্সটে সেটা চিহ্নিত করুন। এটি আপনাকে উত্তরগুলো থেকে একটি বেছে নিতে সহায়তা করতে পারে।
- মনে রাখবেন যে প্রশ্নের নির্দিষ্ট বিষয়ের প্রতি ফোকাস রেখে আপনার নোটগুলি হওয়া উচিত।



- পরীক্ষার আগের দিন, পার্ট A-তে আপনি কতটা সময় ব্যয় করবেন তা পরিকল্পনা করে নিন; এটা পরীক্ষার দিন প্রতিটি প্রশ্নের উত্তর দেয়ায় আপনাকে দক্ষ করে তুলতে সহায়তা করবে।

পর্যালোচনা/সম্পাদনার (রিভাইস/এডিট) নমুনা প্রশ্নাবলী পাঠ A

Sample 1: Select the best correction/s for an error (or errors).

Read this paragraph.

(1) With its luscious trees and grassy fields stretching like a green ribbon across Manhattan, New York City's Central Park is a natural oasis amid the bustling city. (2) While more than 25 million people visited the park each year, they are also a temporary home to an abundance of migratory birds. (3) During the spring and fall migrations, the park becomes a bird watcher's paradise, prompting scores of avid birders with binoculars in hand to flock to it. (4) More than 270 species of birds, including swallows, thrushes, and at least 25 different species of warblers, have been observed making the park their home in the big city.

How should the paragraph be revised?

- A. Sentence 1: Change **its** to **their**, AND change **is** to **was**.
- B. Sentence 2: Change **visited** to **visit**, AND change **they are** to **it is**.
- C. Sentence 3: Change **becomes** to **became**, AND change **it** to **them**.
- D. Sentence 4: Change **have been** to **had been**, AND change **their** to **its**.



এই প্যারাগ্রাফের সেরা পর্যালোচনা (রিভিশন) নির্ধারণ করতে, আপনি যখন প্যারাগ্রাফের প্রথম (1) বাক্যটি পড়ছেন তখন প্রথম অপশনটিতে লিপিবদ্ধ সম্ভাব্য পরিবর্তনগুলো পড়ুন। যদি কোনো পর্যালোচনা (রিভিশন) করার প্রয়োজন না থাকে, তাহলে আপনি সঠিক উত্তর না পাওয়া পর্যন্ত প্রতিটি বাক্য এবং উত্তরের অপশনগুলো পড়া অব্যাহত রাখুন।

Sample 2: Identify a sentence with an error.

Read this paragraph.

(1) Madison Square Garden is the oldest sports arena in the New York City area, having opened in 1968. (2) The construction of the Garden caused controversy when portions of the iconic Pennsylvania Railroad Station were demolished, leading to the creation of a commission dedicated to preserving New York City's historic landmarks. (3) Although the Garden is home to major sports teams and is a frequent host of major concerts, city officials are concerned that it stands in the way of expanding and modernizing Pennsylvania Station, which operates beneath the arena. (4) In 2013, the city council voted to give the owners of Madison Square Garden a 10-year operating permit, meaning that Madison Square Garden may need to relocate by 2023.

Which sentence should be revised to correct an error in sentence structure?

- E. sentence 1
- F. sentence 2
- G. sentence 3
- H. sentence 4



বাক্যটি শনাক্ত করতে, সময়ের প্রতি লক্ষ্য রেখে প্রথমে বাক্যটি যত্নসহকারে পড়ুন; শুধু চোখ বুলাবেন না। ভুলটি প্যারাগ্রাফের যেকোনো স্থানে থাকতে পারে।



লক্ষ্য করুন যে ভুলটি রয়েছে সুনির্দিষ্টভাবে বাক্যের গঠনে, যার অর্থ হচ্ছে ধারণাগুলোর মধ্যে সম্পর্ক তুলে ধরতে (প্রতিনিধিত্ব করতে), একটি বাক্যে শব্দ ও বাক্যাংশ কীভাবে বসে তার সাথে সম্পর্কিত।

Sample 3: Improve the writing by combining sentences or revising part of a sentence.

Read these sentences.

- (1) Whales are the giants of the ocean, and they spend their lives in underwater song.
(2) They use their voices to attract a mate, call out to one another, and help navigate new environments.

What is the best way to combine the sentences to clarify the relationship between the ideas?

- A. Whales are the giants of the ocean, spending their lives in underwater song, using their voices to attract a mate, calling out to one another, and helping navigate new environments.
- B. Whales, the giants of the ocean, spend their lives in underwater song, use their voices to attract a mate, call out to one another, and help navigate new environments.
- C. Whales are the giants of the ocean, spend their lives in underwater song, use their voices to attract a mate, call out to one another, and help navigate new environments.
- D. Whales, the giants of the ocean, spend their lives in underwater song, using their voices to attract a mate, call out to one another, and help navigate new environments.



বাক্যগুলো সংযুক্ত করতে, নিজেকে জিজ্ঞাসা করুন

1. কোনো শব্দ/ধারণা একাধিকবার ব্যবহৃত হয়েছে কি, যা শুধুমাত্র একবার ব্যবহার করা যেতে পারে?
2. ভিন্ন ভিন্ন ধারণাগুলো কীভাবে সংযুক্ত? সেগুলো কি কোনো কারণ ও প্রভাব, বিপরীতমুখী ধারণাসমূহ, একটি ধারাবাহিকতা, ইত্যাদি প্রতিনিধিত্ব করে?

Sample 1 Explanation

(B) Sentence 2 of the paragraph should be revised to correct the errors in verb tense and pronoun agreement. The paragraph is in the present tense, so the past tense “visited” needs to be changed to “visit.” Additionally, the pronoun “they” needs to be changed to the pronoun “it.” The pronoun refers to “the park,” which is a singular noun; it does not refer to “people,” which is plural. Option B is correct because the revisions in the option correct these errors.

Sample 2 Explanation

(E) Sentence 1 of the paragraph should be revised to correct an error in sentence structure. Specifically, the sentence should be revised to correct a misplaced modifier. As the sentence is written, the phrase “having opened in 1968” incorrectly modifies “the New York City area” instead of modifying “Madison Square Garden.” The correct placement of the phrase would change the beginning of sentence 1 to “Madison Square Garden, having opened in 1968, . . .” Option E correctly identifies sentence 1 as having an error in sentence structure.

Sample 3 Explanation

(D) Option D shows the best way to combine these sentences clearly and precisely because it shows the relationship between the key ideas of whales spending their lives in underwater song and the practical uses of their song.

পর্যালোচনা/সম্পাদনার (রিভাইস/এডিট) উপরিচিত্র পাঠ B

পাঠ B-এর প্রশ্নগুলি টেক্সট পড়ায় আপনার যোগ্যতা পরিমাপ করে এবং তারপর সিদ্ধান্ত গ্রহণে সহায়তা দেয় যা রাইটিংয়ে আপনার সামগ্রিক মান উন্নয়ন করে। যে বিষয়গুলি এইসব টেক্সটে উপস্থাপন করা হয় সেগুলির মধ্যে থাকে ঐতিহাসিক এবং বর্তমান ঘটনাসমূহ; জনগোষ্ঠী, বিভিন্ন স্থান এবং টেকনোলজির বিষয়; বায়োলজিক্যাল সায়েন্স, ফিজিক্যাল সায়েন্স, এবং সোশ্যাল সায়েন্সের বিভিন্ন বিষয়। আপনি যেন দ্রুত খুঁজে নিতে পারেন এবং প্যাসেজের বিশেষ অংশগুলি দেখে নিতে পারেন সেজন্য প্রতিটি বাক্য নম্বরযুক্ত।

টেক্সটে ভুল থাকতে পারে, যেমন

- ভাষার অপব্যবহার
- বাদ পড়া অথবা অহেতুক সহায়ক বিস্তারিত খুঁটিনাটি
- বাদ-পড়া অথবা অনুপযুক্ত পরবর্তী পর্বের জন্য (ট্র্যানজিশনাল) শব্দ, বাক্যাংশ, অথবা বাক্য
- কোনো বাদ-পড়া অথবা অস্পষ্ট ভূমিকা অথবা উপসংহার বিবৃতি
- বিভ্রান্তিকর অথবা অযৌক্তিক গঠন
- ভাষা এবং লেখার মানের সাথে সম্পর্কিত অন্যান্য ভুল-ত্রুটি



পর্যালোচনা/সম্পাদনার (রিভাইস/এডিট) জন্য পরামর্শ পাঠ B

সময়ের প্রতি লক্ষ্য রেখে
প্রথমে টেক্সটটি সতর্কতার
সাথে পড়ুন, শুধু চোখ
বুলাবেন না।

- টেক্সটটি কীভাবে আরও উন্নতভাবে গঠন করা যায় সেবিষয়ে প্রশ্নের উত্তর দেয়ার জন্য টেক্সট থেকে লেখকের উদ্দেশ্য, প্রধান ধারণা, এবং সহায়ক বিস্তারিত বিষয়গুলো আপনার বোঝা প্রয়োজন, সেজন্য মনোযোগ দিয়ে পড়া আবশ্যিক।
- আপনি বিভ্রান্তিকর, অযৌক্তিক, অপ্রয়োজনীয়, অসংগঠিত, অথবা সাধারণত পড়তে কষ্ট হয় এমন বাক্য এবং প্যারাগ্রাফ লক্ষ্য করতে পারেন।
- লক্ষ্য করুন যে, পাঠ B-এ যে ধারাক্রমে আপনার টেক্সট এবং প্রশ্ন(গুলো) পড়া উচিত সেটা পাঠ A থেকে ভিন্ন। পাঠ A-তে আপনার প্রথমে প্রশ্ন পড়া উচিত। পাঠ B-তে, আপনার প্রথমে টেক্সট পড়া উচিত।

এরপর, সময়ের প্রতি লক্ষ্য
রেখে, প্রতিটি প্রশ্ন পড়ুন।

- টেক্সটে ফিরে যান এবং প্রাসঙ্গিক বাক্য অথবা প্যারাগ্রাফগুলি আবার পড়ুন যা প্রশ্নে উল্লেখ করা হয়েছে।
- প্রশ্নে যে বাক্যটির বিষয়ে বলা হয়েছে সেটির আগে ও পরের বাক্যগুলিতেও আপনাকে চোখ বুলিয়ে যেতে হতে পারে।
- প্রয়োজন অনুযায়ী বাক্যটি আবার পড়ে (এবং যতটা সময় পাওয়া যায়), প্রতিটি উত্তরের সম্ভাব্যতা বিবেচনা করুন। অপশনটি সর্বোচ্চ সম্ভাব্য উত্তর দেয় কিনা সে সিদ্ধান্ত নিন।



- পরীক্ষার আগের দিন, পাঠ B-তে আপনি কতটা সময় ব্যয় করবেন তা পরিকল্পনা করুন; এটা পরীক্ষার দিন প্রতিটি প্রশ্নের উত্তর দিতে আপনাকে দক্ষ করে তুলতে সহায়ক হবে।

Game Night

(1) Some people think that board games are outdated and boring, unable to provide much entertainment to today's electronic-savvy teens. (2) But opening a cardboard box full of colorful and sometimes elaborate game pieces can offer a refreshing experience, one that cannot be matched by a video game controller and headset. (3) Playing board games is really quite fun.

(4) Board games have exploded in popularity in the past several years as people have discovered how entertaining and interesting a complex or strategic game can be. (5) In the board game Ticket to Ride, players compete against one another. (6) The goal is to create a long railway that connects destinations on a map. (7) This requires collecting resources and building rail lines in strategic places. (8) The game encourages players to think in new ways, and the brain gets exercise that it needs in order to grow.

(9) Playing board games with others can also help bring people together. (10) When you take part in a board game, you get to know the other players. (11) People separated by generations can find common ground across the table from one another when they are all enjoying the same board game. (12) In addition, playing board games can often encourage discussion among players about a variety of topics. (13) Some games are even developed as learning games and aim to teach players about a topic as they play. (14) In a world where digital interactions tend to occur more frequently than true face-to-face interactions, coming together in person to enjoy a board game can be a fun way to maintain or create connections with other people.

(15) In addition to helping people develop relationships, playing board games gives people an opportunity to hone skills that apply to real life. (16) Competitive board games challenge people to compete and to use strategies to outwit one another. (17) Cooperative board games require players to collaborate and to use their individual strengths to achieve a common goal. (18) The act of playing almost any board game can help a person learn to be a humble winner and a gracious loser and help improve a person's focus, self-control, and critical thinking.

(19) Playing board games is an excellent way to exercise one's brain, engage with other people, and practice essential strategies for handling real-life situations. (20) There are hundreds of competitive and cooperative board games that can provide the ideal balance between entertainment and challenge.



আনুষ্ঠানিক স্টাইল বজায় রাখতে, লেখকেরা প্রায়শই খুব সুনির্দিষ্ট, স্পষ্ট, এবং মাঝে মাঝে উচ্চ মানের অ্যাকাডেমিক ভাষার উপর নির্ভর করে। এই ধরনের প্রশ্নের জন্যে, আপনার পুরোটা লেখা পড়া এবং স্টাইল বিবেচনা করা উচিত, এবং এরপর এই ধারাটি বজায় রাখতে কোন্ অপশনটি সেরা সেটা বিবেচনা করুন।

1. Which revision of sentence 10 best maintains the formal style established in the passage?

- A. When you play a board game with people, you become friendly with them.
- B. When people participate in a board game, they develop relationships with each other.
- C. When people get together for a board game, they learn about each other.
- D. When you become involved in a board game with people, you make friends with the players.

Which sentence should be added after sentence 18 to help develop the ideas in the fourth paragraph (sentences 15–18)?

- E.** Playing board games can teach a person a lot about how to manage the daily obstacles that are a natural part of life.
 - F.** The skills used to play games can be useful, as almost all occupations require people to make decisions that can have positive or negative results.
 - G.** People who learn these things will develop strong interpersonal skills, which are an advantage when developing relationships.
 - H.** Concentrating on a goal, responding well to positive and negative outcomes, and making logical decisions are valuable skills in many situations.
- 3.** Which concluding sentence would best follow sentence 20 and support the main argument presented in the passage?
- A.** People should seek out board games that require players to develop complex strategies to defeat opponents.
 - B.** People should choose board games that appeal to them and encourage friends and family to take a seat at the gaming table.
 - C.** People should play board games that involve significant player interaction as they try to achieve the same or different goals.
 - D.** People should find board games that allow friends and family to reap the benefits of regularly playing games.

Sample 1 Explanation

(B) Option B is the correct response because this revision uses precise, formal language (“participate” and “develop relationships”) that maintains the style established in the passage. In addition, this option avoids using the informal second person (“you”) and instead uses “people” to refer to board-game players, which further contributes to the formal style.

Sample 2 Explanation

(H) Option H is the correct response because this sentence further develops the ideas that are presented in sentence 18 (that playing board games can help a person learn to win and lose with grace and can “help improve a person’s focus, self-control, and critical thinking”). This sentence develops these ideas by explaining that these qualities are valuable in situations beyond playing board games.

Sample 3 Explanation

(B) Option B is the correct response because it logically follows the description in sentence 20 that there are “hundreds of competitive and cooperative board games” with the suggestion that a person should choose one that they find appealing or interesting. The passage explains the benefits of playing board games, and the sentence in option B supports the main argument of the passage by emphasizing that playing board games is a fun way to bring people together.

রিডিং কম্প্রিহেনশনের উপরিচিত্র

এই সেকশনটি সাহিত্য এবং তথ্যমূলক উভয় শ্রেণীর ছয়টি টেক্সট পড়া এবং সেগুলি বোঝার সক্ষমতা মূল্যায়ন করে, এতে নিচে তালিকাভুক্ত যেকোনো ধরনের টেক্সট থাকতে পারে।

তথ্যমূলক ধারায় অন্তর্ভুক্ত হতে পারে	সাহিত্যমূলক ধারায় অন্তর্ভুক্ত হতে পারে
বর্ণনামূলক/ব্যাক্থ্যমূলক টেক্সট	কবিতা
যুক্তিনির্ভর টেক্সট	অভিযানের গল্পসমূহ
ক্রিয়ামূলক বা ফাংশনাল টেক্সট যে ছকে হতে পারে: <ul style="list-style-type: none">ব্যক্তিগত রচনাসমূহস্পিচ বা বক্তৃতাসমূহমতামতমূলক লেখাসমূহশিল্প বা সাহিত্য সম্পর্কিত রচনাসমূহজীবনীগ্রন্থস্মৃতিকথাসাংবাদিকতাঐতিহাসিক, বিজ্ঞান-বিষয়ক, প্রযুক্তিগত, অথবা ব্যাপক পাঠকগোষ্ঠীর জন্য অর্থনীতি-বিষয়ক লেখা	হিস্টোরিকাল ফিকশন (ইতিহাস-ভিত্তিক উপন্যাস) রহস্য মিথ (পৌরাণিক কাহিনী) সায়েন্স ফিকশন (বিজ্ঞান-ভিত্তিক উপন্যাস) বাস্তবধর্মী ফিকশন বা উপন্যাস রূপক গল্প রম্যরচনা (প্যারোডি) রাজনৈতিক বা সামাজিক ব্যঙ্গরচনা



রিডিং কম্প্রিহেনশন সম্পর্কিত পরামর্শ

সময়ের প্রতি লক্ষ্য রেখে প্রথমে টেক্সটটি যত্নসহকারে পড়ুন, শুধু চোখ বুলাবেন না।

- প্রধান বিষয় এবং গুরুত্বপূর্ণ খুঁটিনাটি -উভয়ের সম্পর্কে আপনার একটি সঠিক এবং টেক্সট-নির্ভর ধারণা হয়েছে সেবিষয়টি নিশ্চিত করতে টেক্সটটি যত্নসহকারে পড়ুন।
- যখন পড়ছেন, আপনি কতটা বুঝেছেন সেটি লক্ষ্য করুন; যদি কোনও বাক্য অথবা প্যারাগ্রাফ বিভ্রান্তিকর মনে হয়, তাহলে দ্রুত আবার পড়ার চেষ্টা করুন।

নোট নিন।

- সম্পূর্ণ টেক্সটটি পড়ার সময়, গুরুত্বপূর্ণ খুঁটিনাটি চিনে নিতে, বিষয়গুলির সার-সংক্ষেপ ইত্যাদি মনে রাখতে সংক্ষিপ্ত নোট টুকে রাখুন।

প্রশ্নগুলি মনোযোগ দিয়ে পড়ুন।

- প্রশ্নটিতে কী জিজ্ঞেস করা হচ্ছে সেটি যাতে স্পষ্টভাবে বুঝতে পারেন সেজন্যে মনোযোগ দিয়ে প্রশ্নটি পড়ুন। উদাহরণস্বরূপ, আপনার কি শুধু একটি প্যারাগ্রাফ নাকি একাধিক প্যারাগ্রাফের খুঁটিনাটির প্রতি মনোনিবেশ করা উচিত?
- যদি সময় থাকে, টেক্সটের প্রাসঙ্গিক অংশটি অথবা অংশগুলি পুনরায় পড়ুন।

উত্তরের অপশনগুলো পড়ার আগে উত্তরটি নির্ধারণ করার চেষ্টা করুন।

- প্রতিটি অপশন পড়ার আগে, উত্তর কী হবে ভেবে নিন। তারপর প্রতিটি উত্তরের অপশন পড়ুন, নিশ্চিতভাবে যেগুলো ভুল বলে মনে হচ্ছে সেগুলো বাদ দিন, এবং আপনার ভাবনার সাথে সর্বোচ্চ মানানসইটি বেছে নিন।
- আপনার উত্তরের জন্য শুধু টেক্সটের বিষয়ের উপর নির্ভর করুন (এবং যেখানে প্রাসঙ্গিক সেখানে সম্পূর্ণ হবি অথবা গ্রাফিক্সের উপর)। বিষয়ের উপর আপনার পূর্ব ধারণা বা জ্ঞানের উপর নির্ভর করবেন না।



- পরীক্ষার আগের দিন, রিডিং কম্প্রিহেনশন সেকশনের প্রতিটি টেক্সট ও তার সাথে সম্পূর্ণ প্রশ্নের জন্য আপনি কতটা সময় ব্যয় করবেন তা পরিকল্পনা করুন; এটা পরীক্ষার দিন প্রতিটি প্রশ্নের উত্তরের সঠিক জবাব দানে আপনার দক্ষতা তৈরীতে সহায়ক হবে।

Snoozing While Soaring

- 1 Certain types of birds soar for hundreds of miles, over land, over sea—and never stop to rest. That kind of endurance seems impossible to us, since we as people need time to rest and sleep. Researchers set out to learn how birds could fly for such long distances without restorative rest. They found that for some birds, settling in for a good night’s rest is not always a necessity.
- 2 In 2013 Felix Liechti and his research colleagues at the Swiss Ornithological Institute published results of a study about the flight habits of Alpine swifts, small birds that migrate annually between Europe and Africa. Liechti and his team fitted the birds with small electronic tags that recorded the birds’ acceleration and their pitch, or angle relative to the ground. The data revealed that the birds remained completely airborne during their time in Africa, a period of over 200 days. Since all animals require sleep, the researchers inferred that the birds slept from time to time on their long journey. However, since the electronic tags recorded only movement such as gliding or flying, and not brain waves, the question of whether birds sleep during flight remained unanswered.
- 3 Researcher Niels Rattenborg from the Max Planck Institute for Ornithology also delved into this question. In a 2006 article Rattenborg explained that it was theoretically possible that birds could undergo a certain type of sleep while flying. Like mammals, Rattenborg explained, birds experience different types of sleep, including slow-wave sleep (SWS). Rattenborg argued that SWS during flight is plausible because SWS can happen in one hemisphere of the brain at a time, leaving half of the brain essentially awake while the other half sleeps. The eye associated with the “awake” hemisphere can still function, allowing a bird to see where it is going. Rattenborg decided that electroencephalogram (EEG) recordings of birds’ brain waves would ultimately be necessary to determine whether a bird can actually sleep in flight.
- 4 Eventually, Rattenborg and his team were able to create an experiment to prove this theory by studying frigatebirds from the Galápagos Islands. These enormous birds are good subjects for avian-sleep research because they fly far out to sea to hunt fish. However, unlike many seabirds, they cannot land on the water to rest because the physical build of their body—long wings, poorly webbed feet, and minimal feather waterproofing—makes them unable to take off again from the surface of the water. Rattenborg concluded that they must remain in flight for up to two months at a time.
- 5 In an article from 2016, Rattenborg outlined the team’s research methods and conclusions. The team humanely implanted EEGs on the skulls of several frigatebirds. After analyzing the EEG readings of the birds while in flight, the team determined that the frigatebirds slow-wave slept for about ten seconds at a time at points when the birds were gliding upward via warm air currents, typically the safest part of the flight. While in flight the birds slept for only 45 minutes a day, which is just enough rest for the birds to function during these long flights. They later recovered from the stress of going with very little sleep when they rested for approximately twelve hours each day back on land.
- 6 Using EEG recordings, Niels Rattenborg solved the puzzle of when birds sleep while traveling long distances. His evidence proved that his theory was correct, and the birds proved themselves to be the ultimate multitaskers as they manage sleep and flight at the same time.

1. Read this sentence from paragraph 1.

That kind of endurance seems impossible to us, since we as people need time to rest and sleep.

The words “endurance” and “impossible” in the sentence convey

- A. amazement about the physical capability of birds to remain in flight for extended periods of time over long distances.
 - B. uncertainty about the conditions that allow birds to stay in flight for extended periods of time without rest.
 - C. excitement about the opportunity to share research into how birds fly for extended periods of time.
 - D. skepticism about discovering how birds can fly for extended periods of time with little or no rest.
2. Which sentence from the passage best supports the idea that birds seem to be capable of making prolonged flights without sleeping?
 - E. “The data revealed that the birds remained completely airborne during their time in Africa, a period of over 200 days.” (paragraph 2)
 - F. “In a 2006 article Rattenborg explained that it was theoretically possible that birds could undergo a certain type of sleep while flying.” (paragraph 3)
 - G. “Rattenborg decided that electroencephalogram (EEG) recordings of birds’ brain waves would ultimately be necessary to determine whether a bird can actually sleep in flight.” (paragraph 3)
 - H. “While in flight the birds slept for only 45 minutes a day, which is just enough rest for the birds to function during these long flights.” (paragraph 5)

- 3.** Which statement best summarizes the conclusions of the studies presented in the passage?
- A.** Scientists used monitoring devices to determine that the seconds when migratory birds glide upward in warm air currents are safest for slow-wave sleep.
 - B.** Using monitoring devices, scientists confirmed that migratory birds sleep for an extremely short amount of time while in flight and recuperate by sleeping for an extended period of time after they land.
 - C.** Scientists used monitoring devices to determine that migratory birds require significantly less sleep than many other animals and to show that the birds use only one hemisphere of their brain while flying.
 - D.** Using monitoring devices, scientists confirmed that some types of migratory birds rely on slow-wave sleep cycles in order to stay in flight for extended periods of time.
- 4.** The overall organizational structure of the passage allows the author to
- E.** contrast the significance of research findings related to small migratory birds with those related to large migratory birds.
 - F.** compare the in-flight sleep patterns of the various types of birds examined in several studies.
 - G.** emphasize the role of technology in studying sleep patterns of birds in flight.
 - H.** illustrate how researchers acquired a better understanding of the sleep patterns of birds in flight.

Sample 1 Explanation

(A) Option A is the correct response because it explains that the words “endurance” and “impossible” convey amazement at the birds’ ability to remain in flight for so long without resting—as opposed to human beings, who “need time to rest and sleep” (paragraph 1). Specifically, the word “impossible” implies a sense of wonder or disbelief at the birds’ endurance, which allows them to continue flying for hundreds of miles without stopping. The words “endurance” and “impossible” support the idea expressed later in the passage that these birds are the “ultimate multitaskers” (paragraph 6).

Sample 2 Explanation

(E) Option E best supports the idea that birds seem to be capable of making prolonged flights without sleeping, because it expresses the idea that the birds “remained completely airborne” during “a period of over 200 days” (paragraph 2). This information is significantly more precise than the information in the other answer options. Therefore, option E provides more compelling evidence to support the idea in the question than the other answer options provide.

Sample 3 Explanation

(D) Option D best summarizes the conclusions of the studies presented in the passage. While all the options include some important details about the study of migratory birds, option D accurately states the key conclusion of these studies, which is that these birds “rely on slow-wave sleep cycles in order to stay in flight for extended periods of time” (paragraph 5). Option D’s emphasis on the key conclusion rather than on key details makes it the correct response.

Sample 4 Explanation

(H) Option H best explains the effect of the overall structure of the passage. The passage presents an unresolved question in paragraph 2, while paragraph 3 explains one researcher’s attempt at seeking an answer to the question. Paragraph 4 describes the bird the researchers chose due to its physical makeup and feeding habits. Paragraphs 5 and 6 illustrate the details and outcome of the study, revealing the researchers’ conclusion. Therefore, the overall structure of the passage illustrates how researchers improved their understanding of the sleep patterns of birds in flight.

1.5 গণিত (ম্যাথ) সেকশনের জন্য কীভাবে প্রস্তুত হতে হবে

ম্যাথ সেকশনে রয়েছে কথা এবং কমপিউটেশনাল (গণনামূলক) প্রশ্ন – যা একাধিক উত্তর থেকে বেছে নেয়া অথবা গ্রিড-ইন ফরম্যাটে হতে পারে। সেখানে পাঁচটি গ্রিড-ইন প্রশ্ন এবং 52-টি মাল্টিপল-চয়েস (একাধিক উত্তর থেকে বেছে নেয়া) প্রশ্ন রয়েছে। ম্যাথ বা গণিত প্রশ্নে থাকে গণিতে দক্ষতার প্রয়োগ, গণিত-বিষয়ক শব্দাবলী, এবং গণিত বিষয়ে নিউ ইয়র্ক স্টেটের শিক্ষণ মানের সাধারণ ধারণাসমূহ। যদিও, এই পরীক্ষার একাধিক উদ্দেশ্যের মধ্যে একটি হচ্ছে - সেসব শিক্ষার্থীকে শনাক্ত করা, যারা স্পেশালাইজড হাই স্কুলের শিক্ষা থেকে উপকৃত হবে, SHSAT ম্যাথ বিষয়গুলি জটিল, বহু-ধাপ বিশিষ্ট সমস্যাগুলোয় আপনার পরিচিত গাণিতিক (ম্যাথ) দক্ষতাগুলি প্রয়োগ করা আবশ্যিক করবে।

অষ্টম (8) গ্রেডের প্রশ্নপত্রের (টেস্ট ফর্ম) ম্যাথ প্রশ্নগুলি ঐসব পাঠ্য বিষয়ের উপর যা 7 গ্রেড পর্যন্ত নিউ ইয়র্ক সিটি পাঠ্যক্রমে অন্তর্ভুক্ত। নবম (9) গ্রেডের প্রশ্নপত্রের (টেস্ট ফর্ম) ম্যাথ প্রশ্নগুলি ঐসব পাঠ্য বিষয়ের উপর যা 8 গ্রেড পর্যন্ত নিউ ইয়র্ক সিটি পাঠ্যক্রমে অন্তর্ভুক্ত।

পরবর্তী পৃষ্ঠাগুলিতে SHSAT-এর ম্যাথ সেকশনের প্রস্তুতিতে কীভাবে সহায়তা পাওয়া যেতে পারে সেবিষয়ে বিবিধ পরামর্শের রূপরেখা দেয়া আছে। এর মধ্যে নিম্নলিখিত বিষয়গুলো রয়েছে:

- ম্যাথ বা গণিত বিষয়ে গাণিতিক দক্ষতা বৃদ্ধির জন্য আপনাকে যেসব জিনিস আরও বেশি অনুশীলন করতে হবে সেসম্পর্কে পরামর্শ।
- SHSAT-এর জন্য নির্দিষ্ট কিছু প্রত্যাশার সাথে আপনাকে পরিচিত হবার কিছু পরামর্শ এবং এরফলে সেগুলি অন্যান্য গণিত বা ম্যাথ পরীক্ষা থেকে ভিন্ন হতে পারে
- ম্যাথ বা গণিত মাল্টিপল চয়েস (বহুচয়ন) প্রশ্নের উত্তর দিতে নির্দিষ্ট কিছু পরামর্শ
- ম্যাথ গ্রিড-ইন প্রশ্নাবলীর উত্তর দিতে নির্দিষ্ট কিছু পরামর্শ

দ্রষ্টব্য: সকল ম্যাথ নমুনা প্রশ্নের উত্তর এবং উত্তরের ব্যাখ্যা 23-25 পৃষ্ঠায় পাওয়া যাবে।



গণিত বা ম্যাথ-এ দক্ষতা বৃদ্ধির জন্য কিছু পরামর্শ

গণিত (ম্যাথ) উপকরণসমূহ পর্যালোচনা।

- আপনার গণিত পাঠ্যবই (ম্যাথ টেক্সটবুক) ব্যবহার করুন, স্কুলে অথবা আপনার স্থানীয় লাইব্রেরিতে অন্যান্য গাণিতিক উপকরণ খুঁজে নিন, অথবা আপনি ব্যবহার করতে পারেন এমন উপকরণের পরামর্শ দিতে আপনার শিক্ষককে অনুরোধ জানাতে পারেন।

প্রতিদিন গাণিতিক প্রশ্নাবলী সমাধান করা অনুশীলন করুন। মৌলিক এবং চ্যালেঞ্জিং - উভয় প্রকার প্রশ্নাবলী সমাধান করুন।

- প্রাথমিক প্রশ্নগুলি গণিতের দক্ষতাকে আরও শক্তিশালী করে যেমন ভগ্নাংশের সরলীকরণ এবং পরিসংখ্যানের ধারণার প্রয়োগ।
- অধিক চ্যালেঞ্জিং প্রশ্নগুলির জন্য বহু-ধাপের জটিল সমীকরণ তৈরী করা আবশ্যিক হয়। তাদের বিভিন্ন ধরনের গণিতের দক্ষতা ব্যবহারও আবশ্যিক হতে পারে। উদাহরণস্বরূপ, আপনি ভগ্নাংশ ব্যবহার করতে পারেন, সমীকরণ সমাধান করতে পারেন, এবং পরিসংখ্যান বিষয়ে আপনার জ্ঞান প্রয়োগ করে একটি প্রশ্নের উত্তর দিতে পারেন।
- কোনও প্রশ্নের উত্তর দিতে যদি আপনি অনিশ্চিত হোন, তবে প্রশ্নটি বাদ রাখুন এবং অন্য প্রশ্নগুলোর উত্তর দেয়ার পর আবার সেটায় ফিরে আসুন। অন্য প্রশ্নগুলির উত্তর দেয়ার পর, আপনার ঐ প্রশ্নটির সমাধানের জন্য আরও ভাল ধারণা হতে পারে।



ম্যাথ সেকশনের উত্তর দেয়ার সময় আপনাকে যেসব বিষয় মনে রাখতে হবে

গাণিতিক (ম্যাথ) শব্দাবলী, বিভিন্ন সংকেত, এবং সূত্র (ফর্মুলা) যা আপনি ম্যাথ ক্লাসে ব্যবহার করেন সেগুলো মুখস্থ করুন।

- আপনাকে গাণিতিক শব্দাবলীর অর্থ বুঝতে হবে যা আপনার গ্রেড লেভেলের জন্য উপযুক্ত, যেমন "প্যারালেল (সমান্তরাল)" এবং "পারপেন্ডিক্যুলার (সমকোণিক)", এবং এর পাশাপাশি এইসব সংকেত যা এই শব্দাবলীর বদলে ব্যবহৃত হয়।
- আপনি গণিত-বিষয়ক শব্দাবলী, সংকেত, এবং ফর্মুলা পাবেন, যেমন বিভিন্ন আকারের জন্য পেরিমিটার (পরিধি), এবং এরিয়া (আয়তক্ষেত্র), যা আপনার নিউ ইয়র্ক স্টেটের শিক্ষণ মানের 7 এবং 8 গ্রেডের ম্যাথ ক্লাসের বিভিন্ন বিষয়ে ও অনলাইনে পাওয়া যাবে।
- এইসব শব্দাবলী, সংকেত, ফর্মুলার সংজ্ঞা এবং ব্যাখ্যা এই পরীক্ষার বুকলেটে পাওয়া যাবে না। মুখস্থ না করা এবং সাবলীলভাবে ব্যবহারে সক্ষম না হওয়া পর্যন্ত বিভিন্ন প্রশ্নের সমাধানের জন্য এগুলি ব্যবহার করা অনুশীলন করুন।

প্রশ্ন সমাধানের সময় ক্যালকুলেটর ব্যবহার করবেন না।

- SHSAT দেয়ার সময় ক্যালকুলেটর ব্যবহার অনুমোদিত নয়।



- পরীক্ষার আগের দিন, পার্ট B-তে আপনি কতটা সময় ব্যয় করবেন সেই পরিকল্পনা করুন; এটা পরীক্ষার দিন প্রতিটি প্রশ্নের উত্তর দেয়ার জন্য আপনাকে দক্ষ করে তুলতে সহায়তা করবে।



গাণিতিক (ম্যাথ) সমস্যা সমাধানের জন্য পরামর্শ

প্রতিটি প্রশ্ন মনোযোগ দিয়ে পড়ুন।

- প্রশ্ন থেকে সকল গুরুত্বপূর্ণ তথ্য ব্যবহার করে যেন জটিল সমস্যাগুলো সঠিকভাবে সাজিয়ে নিতে পারেন সেজন্যে যত্নসহকারে পড়ুন।
- সমস্যা সমাধানের সময় আপনি যেন সকল তথ্যের অন্তর্ভুক্তি নিশ্চিত করতে পারেন সেজন্যে নমুনা 1-এ যেভাবে আছে, সেভাবে প্রশ্নটি চিহ্নিত করুন।
- প্রশ্ন থেকে শব্দসমূহ পরিবর্তন করে গাণিতিক (ম্যাথ) সংকেতে রূপান্তরিত করুন (যেভাবে নমুনা 1 এবং নমুনা 2-এ দেয়া আছে)।

Sample 1

The $+$ sum of two consecutive integers $x, x+1$ is $= -15$. If 1 is added to the smaller integer and 2 is subtracted from the larger integer, what is the **product** of the two resulting integers?



সমস্যা সমাধানে প্রস্তুতি গ্রহণ করতে প্রশ্নটি মার্ক করুন।

Sample 2

J Jenny starts a game with $2K$ twice as many marbles as Keiko. Jenny gives Keiko 5 marbles $J-5$ but she still has 10 more than Keiko. How many marbles did Jenny have to start with?

- A. 25
- B. 30
- C. 35
- D. 40



প্রশ্ন থেকে শব্দগুলোকে গাণিতিক সংকেতে পরিবর্তন করুন।

যেসব প্রশ্নে আকৃতি ও ডায়াগ্রাম দেয়া
নেই সেই প্রশ্নগুলোর জন্য সেগুলো
আঁকুন।

➤ প্রশ্নটি যা বর্ণনা করছে, সেটা কল্পনা করতে আপনাকে সহায়তা করার জন্য, নিচে উদাহরণ
অনুযায়ী বিভিন্ন আকৃতি অথবা রেখাচিত্র (ডায়াগ্রাম) আঁকুন।

নমুনা 3:

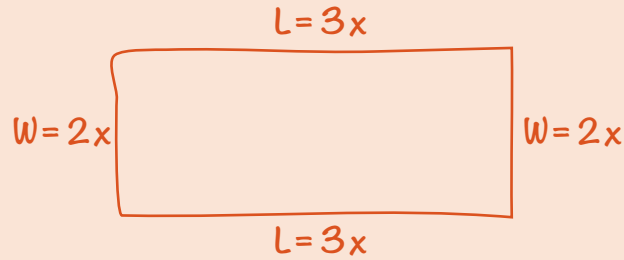

The perimeter of a rectangle is 510 centimeters. The ratio of the length to the width is 3:2. What are the dimensions of this rectangle?

- E. 150 cm by 105 cm
- F. 153 cm by 102 cm
- G. 158 cm by 97 cm
- H. 165 cm by 90 cm



আকৃতি (ফিগার) এবং
রেখাচিত্রগুলোতে (ডায়াগ্রাম)
লেবেল দিন।

একেকবার একটি একটি
ধাপ করুন।

➤ কোনো কোনো প্রশ্ন একটি ধারাবাহিক ধাপকে যুক্ত করতে বলে। নিচের উদাহরণের মত,
বহু-ধাপ বিশিষ্ট সমস্যাগুলো সমাধান করতে, একটি একটি করে ধাপ লিখুন।

নমুনা 4:

$$\begin{aligned}1 \text{ dollar} &= 7 \text{ lorgs} \\1 \text{ dollar} &= 0.5 \text{ dalt}\end{aligned}$$

Malik has 140 lorgs and 16 dalts. If he exchanges the lorgs and dalts for dollars according to the rates above, how many dollars will he receive?

- A. \$28
- B. \$52
- C. \$182
- D. \$282

$$\frac{140}{x} = \frac{7}{1}$$

$$7x = 140$$

$$x = \$20$$

$$\frac{16}{x} = \frac{0.5}{1}$$

$$0.5x = 16$$

$$x = \$32$$

$$20 + 32 = \$52$$



ধাপ 1: লর্গগুলোকে (lorgs)
ডলারে পরিবর্তন করুন।



ধাপ 2: ডাল্টগুলোকে (dalts)
ডলারে পরিবর্তন করুন।



ধাপ 3: আপনার পরিবর্তনকৃত
লর্গগুলো (lorgs) এবং ডাল্টগুলো
(dalts) যোগ করুন।



ম্যাথ মাল্টিপল্-চয়েস প্রশ্নাবলীর জন্য পরামর্শ

অধিকাংশ মাল্টিপল্-চয়েস প্রশ্নাবলীর জন্য অংক-কষে ফলাফল বের করে উত্তর দেয়া উচিত।

- ▶ প্রথমে উত্তরের অপশনগুলি দেখার আগে সমস্যাটির সমাধান বের করে উত্তরের অপশনগুলি দেখা অধিক কার্যকর এবং তারপর সঠিক উত্তরটি পেতে শুদ্ধতা যাচাই করার চেষ্টা করা উচিত।

কাগজে লিখে সমস্যাগুলোর সমাধান বের করা (মনে-মনে হিসেব না কষে) এবং বাছাই করার পরিবর্তে সমাধানে মনোনিবেশ করা হচ্ছে শ্রেষ্ঠ উপায়।

- ▶ আপনি যখন উত্তরটি পেয়ে যাবেন, এরপর তালিকাভুক্ত জবাবগুলো দেখুন। আপনার উত্তরটি যদি তালিকাভুক্ত জবাবগুলোর মধ্যে থাকে, সেটা চিহ্নিত করুন। যদি না থাকে, প্রশ্নটি আবার পড়ুন এবং পুনরায় সমাধান করুন।
- ▶ আপনার উত্তর যদি উত্তরের অপশনগুলির মধ্যে না থাকে, আপনার উত্তরটি অন্যভাবে লেখা বিবেচনা করুন। উদাহরণস্বরূপ; $\frac{5}{9}(3 + x)$ উল্লিখিত সবগুলোর সমমান: $\frac{5(3 + x)}{9}$ এবং $\frac{5}{3} + \frac{5}{9}x$ এবং $\frac{5}{3} + \frac{5x}{9}$ ।
- ▶ এরপরও যদি আপনার উত্তরটি, উত্তরের অপশনগুলির মধ্যে না থাকে, তাহলে আপনার সর্বোচ্চ অনুমানটি বেছে নিন এবং/অথবা সময় থাকলে পরে আবার এই প্রশ্নে ফিরে আসুন।

Sample 1 Explanation

If x is the smaller consecutive integer, then $x + 1$ is the larger consecutive integer. Use their sum -15 to find x :

$$x + (x + 1) = -15$$

$$2x + 1 = -15$$

$$2x = -16$$

$$x = -8$$

The two consecutive integers are -8 and -7 .

One is added to the smaller integer: $-8 + 1 = -7$.

Two is subtracted from the larger integer: $-7 - 2 = -9$.

Find the product: $-7 \times -9 = 63$.

Sample 2 Explanation

(D) Set up some equations.

Jenny (J) has twice as many marbles as Keiko (K): $J = 2K$

Jenny gives Keiko 5 marbles, so now they each have: $J - 5$ and $K + 5$ marbles.

Jenny still has 10 more than Keiko:

$$J - 5 = (K + 5) + 10$$

To find how many marbles Jenny had to start with, solve $J = 2K$ for K and substitute that into the second equation:

In equation $J = 2K$, solve for K : $K = \frac{J}{2}$.

Substitute $\frac{J}{2}$ in for K .

$$J - 5 = (K + 5) + 10$$

$$J - 5 = \left(\frac{J}{2} + 5\right) + 10$$

$$J - 5 = \frac{J}{2} + 15$$

$$\frac{J}{2} = 20$$

$$J = 40 \text{ marbles}$$

Sample 3 Explanation

(F) Let $2x =$ the width and $3x =$ the length.

Draw the rectangle to help visualize.

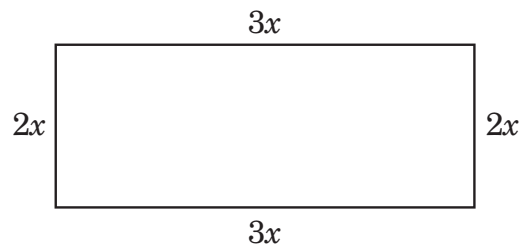

Since $2w + 2l = P$, we get

$$2(2x) + 2(3x) = 510$$

$$4x + 6x = 510$$

$$10x = 510$$

$$x = 51$$

$$2x = 102\text{cm and } 3x = 152 \text{ cm}$$

Sample 4 Explanation

(B) Use proportions to make the conversions:

Lorgs to dollars:

$$\frac{140}{x} = \frac{7}{1}$$

$$7x = 140$$

$$x = \$20$$

Dalts to dollars:

$$\frac{16}{x} = \frac{0.5}{1}$$

$$0.5x = 16$$

$$x = \$32$$

$$\text{Total dollars} = 20 + 32 = \$52$$

গণিত বা ম্যাথ গ্রিড-ইন প্রশ্নগুলো কীভাবে পূরণ করতে হবে

গণিত বা ম্যাথ সেকশনটিতে পাঁচটি গ্রিড-ইন প্রশ্ন রয়েছে যেগুলোর জন্যে শিক্ষার্থীদের কমপিউটেশনাল (গণনামূলক) সমস্যা সমাধান করবে এবং তাদের মাল্টিপল চয়েস অপশনের পরিবর্তে সঠিক গাণিতিক উত্তর প্রদান করতে হবে।

- ▶ প্রতিটি প্রশ্নের গ্রিড পাঁচটি কলাম (স্তম্ভাকার) দিয়ে তৈরি। যখন আপনি গ্রিডে আপনার উত্তরগুলো লিপিবদ্ধ করবেন, বাম দিক থেকে শুরু করুন।
- ▶ প্রতিটি গ্রিড-ইন প্রশ্নের জন্যে, গ্রিডের উপরের বক্সে আপনার উত্তরটি লিখুন।
- ▶ প্রতিটি বক্সে শুধু একটি সংখ্যা অথবা দশমিক চিহ্ন লিখুন। যদি আপনার উত্তরে দশমিক পয়েন্ট থাকে তাহলে "." চিহ্ন ব্যবহার করুন।
- ▶ আপনি যে সংখ্যা অথবা চিহ্নটি লিখেছেন সেটার সাথে যে বক্সটি মিলবে সেটার নিচের বৃত্তটি পূরণ করুন।

EXAMPLE A
(Answer: 5)

Write the answer in these boxes. →

5				
−
0	0	0	0	0
1	1	1	1	1
2	2	2	2	2
3	3	3	3	3
4	4	4	4	4
●	5	5	5	5
6	6	6	6	6
7	7	7	7	7
8	8	8	8	8
9	9	9	9	9

Fill in the circles that correspond to the answer written in the boxes.

EXAMPLE B
(Answer: 3.2)

Negative sign →

3	.	2		
−	.	●	.	.
0	0	0	0	0
1	1	1	1	1
2	2	●	2	2
●	3	3	3	3
4	4	4	4	4
5	5	5	5	5
6	6	6	6	6
7	7	7	7	7
8	8	8	8	8
9	9	9	9	9

← Decimal point

গণিত বা ম্যাথ গ্রিড-ইন প্রশ্নগুলো কীভাবে পূরণ করতে হবে (অব্যাহত)

- ▶ গ্রিডের বামে প্রথম কলামটি (সুস্ভাকার) শুধুমাত্র বিয়োগাত্মক (নেগেটিভ) চিহ্ন লেখার জন্যে, উদাহরণ C-এ যেভাবে দেখানো হয়েছে। যদি আপনার উত্তরটি ধনাত্মক (পজিটিভ) হয়, তাহলে প্রথম কলামটি খালি রাখুন এবং দ্বিতীয় কলাম থেকে আপনার উত্তর লিপিবদ্ধ করুন।

EXAMPLE C
(Answer: -1.5)

Negative sign →

Decimal point ←

- ▶ যখন আপনার উত্তরে একটি দশমিক থাকবে, তখন আপনি যে বৃত্তগুলো পূরণ করছেন সেগুলো যেন আপনার উত্তরের সবগুলো অংশের সাথে মিলে তা নিশ্চিত করুন। উদাহরণস্বরূপ, যদি আপনার উত্তর 0.78 হয়, তাহলে 0, ".", 7, এবং 8, এর নিচের বৃত্তগুলো ভরাট করুন - উদাহরণ D-এর মত। লক্ষ্য করুন যে .78 লেখা উত্তরটিও সঠিক বলে গৃহীত হবে - উদাহরণ E-এর মত।

EXAMPLE D
(Answer: 0.78)

EXAMPLE E
(Answer: .78)

উদাহরণ D এবং E-এ একই উত্তর ভিন্ন গ্রহণযোগ্য উপায়ে প্রদর্শিত হয়েছে।

গণিত বা ম্যাথ গ্রিড-ইন প্রশ্নগুলো কীভাবে পূরণ করতে হবে (অব্যাহত)

- ▶ কোনো উত্তরের মাঝখানে কোনো বক্স খালি রাখবেন না। যদি আপনার উত্তরে মাঝখানে একটি বক্স খালি থাকে, তাহলে উত্তরটি ভুল হিসেবে স্কোর করা হবে। উদাহরণস্বরূপ, যদি আপনার উত্তর 308 হয়, তাহলে **উদাহরণ F** হচ্ছে আপনার উত্তর দেয়ার গ্রহণযোগ্য উপায়। **উদাহরণ G**-এ, 0-এর পরিবর্তে 3 এবং 8-এর মাঝখানে একটি বক্স খালি রয়েছে, —আপনার এভাবে দেয়া উত্তর গ্রহণযোগ্য হবে না এবং ভুল হিসেবে স্কোর করা হবে।

EXAMPLE F
(Answer: 308)

	3	0	8
-	.	.	.
0	0	0	0
1	1	1	1
2	2	2	2
3	3	3	3
4	4	4	4
5	5	5	5
6	6	6	6
7	7	7	7
8	8	8	8
9	9	9	9

EXAMPLE G
(Answer: 38)

	3		8
-	.	.	.
0	0	0	0
1	1	1	1
2	2	2	2
3	3	3	3
4	4	4	4
5	5	5	5
6	6	6	6
7	7	7	7
8	8	8	8
9	9	9	9

- ▶ অব্যবহৃত বক্সগুলোর নিচের কোন বৃত্ত ভরাট করবেন না, **উদাহরণ H**-এ যেভাবে দেখানো হয়েছে। উদাহরণ H-র উত্তর 3,080 হিসেবে স্কোর করা হবে কারণ 0-এর জন্যে শেষ কলাম বা স্তম্ভের নিচের বৃত্ত ভরাট করা হয়েছে, যদিও আপনার অভিপ্রায় ছিল 308 উত্তর দেয়া।

EXAMPLE H
(Answer: 3080)

	3	0	8
-	.	.	.
0	0	0	0
1	1	1	1
2	2	2	2
3	3	3	3
4	4	4	4
5	5	5	5
6	6	6	6
7	7	7	7
8	8	8	8
9	9	9	9

গ্রিড-ইন সম্পর্কে গুরুত্বপূর্ণ দ্রষ্টব্য

- আপনার উত্তরের জন্য স্কোর পেতে, গ্রিডের বৃত্ত অবশ্যই ভরাটকৃত হতে হবে।
- যদি আপনি উত্তরটি বক্সে লিখে থাকেন কিন্তু গ্রিডের বৃত্তগুলো ভরাট না করেন, তাহলে আপনার উত্তরটি ভুল হিসেবে স্কোর করা হবে।
- আপনার বক্সে লেখা উত্তরের সাথে যে বৃত্তগুলো ভরাট করেছেন সেগুলো না মিলে, তাহলে আপনাকে বৃত্তগুলো অনুযায়ী স্কোর দেয়া হবে, উদাহরণ H-এ যেভাবে দেখানো হয়েছে।
- যদি একটি কলামের (স্তম্ভের) জন্যে একাধিক বৃত্ত ভরাট করা হয়, তাহলে আপনার উত্তর ভুল হিসেবে স্কোর করা হবে।
- শুধুমাত্র সম্পূর্ণভাবে সঠিক গাণিতিক উত্তরকেই সঠিক হিসেবে স্কোর দেয়া হবে, এমনকি আপনি দু'ঘটনাবশত ভুল কলামে (স্তম্ভে) লেখা শুরু করলেও।
- যদি আপনি দু'ঘটনাবশত একটি পূর্ণ নাম্বারের শেষে একটি দশমিক পয়েন্ট যোগ করেন (এবং কোন মান বা শূন্য এর পরে বসাননি), তাহলে আপনার উত্তর ঐ পূর্ণ নাম্বার হিসেবে স্কোর করা হবে। উদাহরণস্বরূপ, উদাহরণ A-এর মত যদি আপনার উত্তর হয় 5, কিন্তু 5. অথবা 5.0 হিসেবে পূরণ করা হয়েছে, সেক্ষেত্রে স্কোর প্রদানের সময় উত্তরটি 5 হিসেবে গণ্য করা হবে।

2.1 আপনাকে পরীক্ষার অধিবেশনে কী কী আনতে হবে

আপনাকে পরীক্ষার অধিবেশনে উল্লিখিতগুলো **অবশ্যই** আনতে হবে:

- ✓ আপনি ও আপনার পিতামাতা/অভিভাবক দ্বারা স্বাক্ষরকৃত আপনার SHSAT পরীক্ষার টিকেট
- ✓ চোখা (শার্প) নম্বর 2 পেন্সিলসমূহ (আপনি কোনো কলম ব্যবহার করতে পারবেন না)
- ✓ ইরেজার
- ✓ সহায়ক টেকনোলজি (যদি IEP এবং টেস্ট টিকেটে উল্লেখ করা থাকে)

শিক্ষার্থীরা **আনতে পারে**, কিন্তু কোনো বাধ্যবাধকতা নেই:

- ✓ স্ল্যান্ট বোর্ড
- ✓ পেন্সিল গ্রিপ
- ✓ FM ইউনিট
- ✓ হাইলাইটার
- ✓ একটি ঘড়ি যা নিঃশব্দে চলে এবং কোনো ক্যালকুলেটর নয়
- ✓ মোড়ানো নয় এবং নিঃশব্দ একটি স্ল্যাক (শিক্ষার্থীরা পরীক্ষা শুরু হবার আগে তাদের স্ল্যাক খেতে পারে; পরীক্ষা চলাকালে স্ল্যাকস্ খাওয়ার অনুমতি নেই।)
- ✓ পানি (একটি নরম অথবা প্লাস্টিকের কন্টেইনারে যা খোলা বা বন্ধ করার সময় আওয়াজ করে না)

2.2 কী কী আনা যাবে না

অনুমোদিত নয়

- ✗ ক্যামেরা
- ✗ ক্যালকুলেটর
- ✗ স্মার্ট ওয়াচ
- ✗ MP3 প্লেয়ার/আইপড
- ✗ ট্যাবলেট/আইপ্যাড, ইবুক রিডার
- ✗ স্মার্ট ফোন, সেল ফোন এবং অন্য যেকোন ইলেক্ট্রনিক যন্ত্রপাতি
- ✗ বাইরের লেখা সামগ্রী
- ✗ সোডা, জুস অথবা পানি ছাড়া অন্য যেকোনো পানীয়; পানি হলো একমাত্র পানীয় যা পরীক্ষা কেন্দ্রে অনুমোদিত

সেল ফোন সংক্রান্ত দ্রষ্টব্য

পরীক্ষার সাইটে সেল ফোন অনুমোদিত কিন্তু:

1. সেগুলি বন্ধ (অফ) করে রাখতে হবে
 2. পরীক্ষার সময় সেগুলো আপনার সাথে থাকতে পারবে না – এর অর্থ হচ্ছে সেগুলো আপনার পকেটে, হাতে, অথবা ডেস্কে থাকতে পারবে না
- আপনার সেল ফোন কোথায় রাখতে হবে সেবিষয়ে পরীক্ষা শুরুর আগে পরীক্ষা কেন্দ্র থেকে নির্দেশনা দেয়া হবে। পরীক্ষা কেন্দ্র কর্তৃক নির্ধারিত নিয়মানুযায়ী সেল ফোন/ক্যামেরা/ইলেক্ট্রনিক যন্ত্রপাতি বন্ধ করে কোথায় রাখতে হবে সেবিষয়ে আপনাকে নির্দেশনা দেয়া হবে।

প্রদান করা হবে

- ✓ পরীক্ষার বুকলেট
- ✓ উত্তর পত্র বা অ্যানসার শীট
- ✓ খসড়া জন্য কাগজ বা স্ক্র্যাপ পেপার, যা বুকলেটের সাথে সংযুক্ত থাকে এবং গাণিতিক হিসাব করার জন্য নোট নিতে ব্যবহার করা যাবে এবং সেটা পরীক্ষার শেষে সংগ্রহ করা হবে
- ✓ শুধু ELL শিক্ষার্থীরা DOE-র নয়টি ভাষার একটিতে ম্যাথের বাইলিসুয়াল বা দ্বিভাষীক শব্দকোষ (গ্লসারি) পাবে: আরবি, বাংলা, চায়নিজ, ফ্রেঞ্চ, হেশিয়ান ক্রিওল, কোরিয়ান, রাশিয়ান, স্প্যানিশ এবং উর্দু।

2.3 পরীক্ষা দিনের প্রত্যাশা

- SHSAT পরীক্ষার টিকেটে নির্দেশিত সময়ে পরীক্ষা কেন্দ্রে পৌঁছানোর ব্যাপারটি নিশ্চিত করুন। মনে রাখবেন এটি হলো উপস্থিত হবার সময়, পরীক্ষা শুরুর নয়। আপনার টিকেটে উল্লেখিত সময়ে পৌঁছানোর পরপরই যত শীঘ্রই সম্ভব পরীক্ষাটি শুরু হবে। কোনো কোনো ক্ষেত্রে, পরীক্ষার টিকেটে উল্লেখিত সময়ের এক ঘণ্টা অথবা তার অধিক সময় পরেও পরীক্ষা শুরু হতে পারে। পরীক্ষা কখন শেষ হবে এবং শিক্ষার্থীরা কখন ছাড়া পাবে সেব্যাপারে আপনার পরীক্ষার সাইট আপনাকে একটি আনুমানিক সময় দিতে পারে।
- পরীক্ষা শুরুর পূর্বে, আমাদের সাইট কর্মীগণ প্রতিটি পরীক্ষার রুমে শিক্ষার্থীদের একটি ছবি তুলবে অথবা ভিডিও ধারণ করবে। এই ছবিগুলো কেবল পরীক্ষার নিরাপত্তার জন্য ব্যবহার করা হবে।
- সকল শিক্ষার্থী যারা SHSAT পরীক্ষা দিচ্ছে তারা অবশ্যই পুরো স্ট্যান্ডার্ড টেস্ট পরিচালনার সময়ে (180 মিনিট) পরীক্ষার রুমেই থাকবে, এর ব্যতিক্রম শুধু বাথরুম ব্যবহারের সময়।
- বর্ধিত সময়: পরীক্ষা পরিচালনার স্ট্যান্ডার্ড সময় (180 মিনিট) অতিক্রান্ত হয়ে গেলে, যেসব শিক্ষার্থী বর্ধিত সময় প্রাপ্ত তারা পরীক্ষা শেষ হয়ে গেলে পরীক্ষার কক্ষ ত্যাগ করতে পারবে। এই শিক্ষার্থীদের মাঝে, যারা স্ট্যান্ডার্ড অ্যাডমিনিস্ট্রেশন সময়ের প্রথম 180 মিনিট অতিক্রান্ত হবার পর রুম ছাড়তে চায়, তাহলে তারা SHSAT-র বাকি সময়টুকু ইচ্ছে করেই ছেড়েছে তা বোঝাতে তাদের অবশ্যই সাইন আউট করতে হবে। এই বিশেষ সুবিধা প্রাপ্ত শিক্ষার্থীরা 180 মিনিট পরে একটি বিরতি পাবে, এবং তারপর আবার 90 মিনিট পার হয়ে যাবার পর আরেকবার বিরতি পাবে।

2.4 উত্তর-পত্র বা অ্যানসার শীট পূরণকরণ

পরীক্ষা দেয়ার আগে, আপনার উত্তরপত্রের সাইড 1-এ আপনি গুরুত্বপূর্ণ তথ্য পূরণ করবেন। প্রথমত, আপনার উত্তরপত্রে প্রদত্ত একটি বিবৃতি আপনাকে পড়তে ও স্বাক্ষর করতে বলা হবে যেখানে উল্লেখ করা আছে যে আপনি পরীক্ষা দেয়ার জন্য যথেষ্ট সুস্থ, নিউ ইয়র্ক সিটির একজন বাসিন্দা, এবং সঠিক গ্রেড স্তরের জন্য পরীক্ষাটি দিচ্ছেন।

- আপনি যদি ভালো বোধ না করেন, আপনাকে দ্রুত টেস্ট প্রক্টরকে (পরীক্ষা পরিচালক) জানাতে হবে; আপনার পরীক্ষা শুরু অথবা বিবৃতিটি স্বাক্ষর করা উচিত হবে না। যদি আপনি পরীক্ষার নিরাপত্তামূলক মোড়কটি খোলেন এবং পরীক্ষা শুরু করেন, তাহলে এরপর আপনি অসুস্থতা বোধের কারণে মেক-আপ পরীক্ষার অনুরোধ জানাতে সক্ষম নাও হতে পারেন।
- আপনি সঠিক গ্রেড স্তরের জন্য পরীক্ষা দিচ্ছেন তা নিশ্চিত হোন।

যখন আপনাকে পরীক্ষা শুরু করতে বলা হবে, তখন উত্তরপত্রে আপনার উত্তরগুলো চিহ্নিত করতে উপযুক্ত বৃত্তগুলো সম্পূর্ণরূপে পূরণ করুন। বৃত্তগুলো আপনি গভীর এবং গাঢ়ভাবে পূরণ করছেন কি না তা নিশ্চিত করুন। উত্তরপত্র বা অ্যানসার শীটে যেন কোনো অযথা দাগ না পড়ে সে ব্যাপারে সতর্ক থাকুন। যদি আপনি একটি উত্তর পরিবর্তন করেন, তবে আপনার আগে দেয়া উত্তরটি সম্পূর্ণরূপে মুছে ফেলুন। প্রতিটি প্রশ্নের শুধুমাত্র একটি সঠিক উত্তর আছে। যদি আপনার উত্তরপত্রে কোনো একটি প্রশ্নের জবাবে একাধিক বৃত্ত ভরাট করা হয়, সেই উত্তরটি ভুল হিসেবে স্কোর দেয়া হবে।

উত্তর চিহ্নিত করার নমুনা				
(A)	(B)	(C)	●	সঠিক
⊗	(B)	(C)	(D)	ভুল
(A)	⊗	(C)	(D)	ভুল
(A)	(B)	⊗	(D)	ভুল
(A)	(B)	●	●	ভুল

আপনি চাইলে ELA অথবা ম্যাথ প্রশ্নের উত্তরের জন্য কাজ করতে আপনার পরীক্ষার বুকলেটে অথবা প্রদত্ত খসড়া কাগজে (স্ক্র্যাপ পেপারে) লিখতে পারেন, কিন্তু নম্বর পেতে হলে আপনার উত্তরগুলো অবশ্যই উত্তর পত্রে বা অ্যানসার শীটে লিপিবদ্ধ করতে হবে। সময় শেষ হয়ে যাবার পর আপনার উত্তর পত্র বা অ্যানসার শীটে আর কোনো উত্তর দিতে পারবেন না। পরীক্ষার বুকলেটে অথবা প্রদত্ত খসড়া কাগজে (স্ক্র্যাপ পেপারে) লেখা তথ্য উত্তর হিসেবে বিবেচিত হবে না।

2.5 শিক্ষার্থীর অসদাচরণ

SHSAT-এর জন্য পরীক্ষার সুরক্ষা গুরুত্বপূর্ণ। যেমন, প্রতিটি শিক্ষার্থী পরীক্ষার অভিজ্ঞতা যেন সমমানের হয় সেটা নিশ্চিত করতে নিম্নলিখিত নিয়মগুলো কঠোরভাবে প্রয়োগ করা হয়।

- পরীক্ষার সময় আপনি অন্য শিক্ষার্থীদের সাথে কোনোভাবেই যোগাযোগ করার চেষ্টা করতে পারবেন না। এর মধ্যে রয়েছে, তবে এতেই সীমাবদ্ধ নয়:
 - কথা বলা, কিছু লিখা, এবং নোট আদান প্রদান করা
 - পরীক্ষার বুকলেট অথবা উত্তর পত্র বা অ্যানসার শীট শেয়ার করা
 - অন্য কোনো শিক্ষার্থীর উত্তর দেখা
 - পরীক্ষার প্রশ্নগুলো রেকর্ড করা
 - কোনো সেল ফোন, ক্যামেরা অথবা অন্য কোনো ইলেকট্রনিক ডিভাইস সাথে রাখা (ওটা বন্ধ অবস্থায় বা অফ করা থাকলেও)।
- পরীক্ষা শেষে, আপনাকে থামতে বলা হবে এবং পেন্সিল নীচে নামিয়ে রাখতে বলা হবে এবং পরীক্ষার উপকরণসমূহ কি করতে হবে সে বিষয়ে নির্দেশনা দেয়া হবে। পরীক্ষার পরিচালক আপনাকে পেন্সিল নীচে নামিয়ে রাখতে বলার পর, আপনি পরীক্ষার উপকরণসমূহে আর কিছু লিখতে পারবেন না, এতে অন্তর্ভুক্ত, কিন্তু এতেই সীমাবদ্ধ নয়:
 - বাবলগুলো গাঢ় করা
 - বাবলগুলোতে বৃত্ত আঁকা
 - উত্তর মোছা
- পরীক্ষা কেন্দ্রের বাইরের কারো সাথে পরীক্ষার প্রশ্ন ও উত্তর শেয়ার করা যাবে না।

যদি এই কার্যকলাপগুলির মধ্যে কোনোটি শিক্ষার্থীরা করে তাহলে তাদের পরীক্ষা বাতিল হয়ে যাবে।

- অষ্টম (8) গ্রেডের শিক্ষার্থীরা পরবর্তী শিক্ষা বছরের আগে আর পরীক্ষা দেয়ার অনুমতি পাবে না।
- নবম (9) গ্রেডের শিক্ষার্থীরা নবম (9) গ্রেড শেষ হয়ে যাবার পর আর পরীক্ষা দেয়ার অতিরিক্ত সুযোগ পাবে না।

যেসব শিক্ষার্থী নিষিদ্ধ কোনো ডিভাইস অন্যান্য সরিয়ে রাখবে না অথবা পরীক্ষা পরিচালকের কাছে দিয়ে দেবে না, তাদেরকে পরীক্ষা দিতে দেয়া হবে না। পরীক্ষা চলাকালীন যেকোনো সময় নিষিদ্ধ ডিভাইস সাথে রাখলে, তা বন্ধ অবস্থায় থাকলেও, পরীক্ষা বাতিল বলে গণ্য হবে। শিক্ষার্থীদের পরবর্তী কোনো একদিন পরীক্ষাটি আবার গ্রহণের সুযোগ দেয়া হবে না।

3.1 পরীক্ষায় অনিয়মের অভিযোগ

সকল শিক্ষার্থীর জন্য SHSAT পরীক্ষা যেন পক্ষপাতহীন, সামঞ্জস্যপূর্ণ পদ্ধতিতে পরিচালিত হয়, সেটা নিশ্চিত করতে NYCDOE কঠোর পরিশ্রম করে। কিন্তু, যদি, আপনি মনে করেন SHSAT চলাকালীন সময় কোনো বিশৃঙ্খলা অথবা সমস্যা হচ্ছে, তবে সাথে সাথেই ব্যাপারটি প্রস্তুতকারকে (পরীক্ষা পরিচালনাকারী) জানান। এটি অন্তর্ভুক্ত হতে পারে পরীক্ষার বুকলেটে ছাপার ভুল, অসঙ্গত মনোযোগ বিনষ্ট, অথবা শিক্ষার্থীর অসদাচরণ। প্রস্তুতকারক (পরীক্ষা পরিচালনাকারী) পরিস্থিতির একটি সমাধান দেয়ার চেষ্টা করবেন এবং পরীক্ষার শেষে আপনার কাছ থেকে একটি লিখিত বিবৃতি গ্রহণ করতে পারেন।

এছাড়া আপনি এবং আপনার পিতামাতা/অভিভাবকগণও চাইলে কোনো সন্দেহজনক পরীক্ষা পরিচালনা (প্রকটরিং) অথবা পরীক্ষায় অনিয়ম সম্পর্কে নিম্নলিখিত যেকোনো একটি উপায়ে রিপোর্ট করতে পারেন:

- 1) একটি ইলেক্ট্রনিক অনুরোধ HSEnrollment@schools.nyc.gov -এই ঠিকানায় জমা দেয়ার মাধ্যমে, অথবা
- 2) ডাকযোগে প্রেরণের প্রমাণসহ, নিচের ঠিকানায় লিখিত অনুরোধের প্রত্যয়িত (সার্টিফাইড) চিঠি পাঠিয়ে:

Office of Student Enrollment
52 Chambers Street, Room 415
New York, NY 10007

পরীক্ষা পরিচালনার তারিখের পর থেকে এক সপ্তাহের মধ্যে সব অনুরোধ অবশ্যই জমা দিতে হবে।

সকল অভিযোগের জন্য, অনুগ্রহ করে পিতামাতা/অভিভাবক এবং শিক্ষার্থীদের নাম, সেই সাথে টেলিফোন নম্বর এবং/অথবা ইমেইল ঠিকানা অন্তর্ভুক্ত করুন। কোনো পরীক্ষা সংক্রান্ত অভিযোগ পরীক্ষা শেষ হওয়ার এক সপ্তাহের পর ডাকে দেয়া হলে, তা বিবেচনা করা হবে না। আলাদা আলাদা ভাবে অভিযোগগুলোর উত্তর দেয়া হবে।

বাড়তি প্রতিকার: যদি আপনার আপিলে আমাদের জবাবে আপনি অসন্তুষ্ট হোন, তাহলে নিউ ইয়র্ক এডুকেশন আইন 310 অনুসারে নিউ ইয়র্ক স্টেট এডুকেশন ডিপার্টমেন্টের কমিশনারের কাছে NYCDOE-এর সিদ্ধান্তের আপিল করতে পারেন। এই ধরনের একটি আপিল কীভাবে করতে হবে সেবিষয়ে আরো জানতে কমিশনারের ওয়েবসাইট counsel.nysed.gov/appeals দেখুন।

The New York City Department of Education

2023 Specialized High School Admissions Test

GENERAL DIRECTIONS

Student Name: _____

Identifying Information

Turn to Side 1 of the answer sheet.

Notify the proctor immediately if you are ill or should not be taking this test. Do not sign the statement or begin the test. Return your answer sheet to the proctor.

Line 1: Read the statement and sign your name in the space following the word “signature.” Do not print your name.

Line 2: Print today’s date, using the numbers of the month, the day, and the year. For example, the date September 21, 2022, would be 9-21-22.

Line 3: Print your birth date, using the numbers of the month, the day, and the year. For example, a birth date of March 1, 2006, would be 3-1-06.

Grid 4: Print the letters of your first name, or as many as will fit, in the boxes. If you have a middle initial, print it in the box labeled “MI.” Then print the letters of your last name, or as much as will fit, in the boxes provided. Below each box, fill in the circle that contains the same letter as the box. If there is a space or a hyphen in your name, fill in the circle under the appropriate blank or hyphen.

Make dark marks that completely fill the circles. If you change a mark, be sure to erase the first mark completely.

Grid 5:

1. Print the name of the school where you are now enrolled in the space at the top of the grid.
2. In the boxes marked “SCHOOL CODE,” print the six-digit code that identifies your school. Below each box, fill in the circle that contains the same letter or number as the box. (You can find your school code on your Test Ticket. If it is not there, tell the proctor, and the proctor will get the school code for you.)
3. If you attend a private or parochial school, fill in the circle marked “P.”

Grid 6: Complete the grid with your date of birth. Print the first three letters of the month in the first box, the number of the day in the next box, and the year in the last box. Then fill in the corresponding circles.

Grid 7: Print your student ID number in Grid 7. You can find your student ID number on your Test Ticket. In the boxes, print your nine-digit student ID number. Below each box, fill in the circle containing the same number as in the box.

Grid 8: In most cases, Grid 8 is already filled in for you. If it is not, copy the letter and numbers shown in the upper-right corner of your test booklet into the boxes. Below each box, fill in the circle containing the same letter or number as the box.

Now review Side 1 to make sure you have completed all lines and grids correctly. Review each column to see that the filled-in circles correspond to the letters or numbers in the boxes above them.

GENERAL DIRECTIONS, continued

Print your test booklet letter and numbers, and your name, first name **first**, in the spaces provided at the top of Side 2 of the answer sheet.

Marking Your Answers

- Mark each of your answers on the answer sheet in the row of circles matching the question number printed in the test booklet.
- Use only a Number 2 pencil.
- If you change an answer, be sure to erase it completely.
- Be careful to avoid making any stray pencil marks on your answer sheet. **Do not make any marks on your answer sheet other than filling in your answer choices.**
- Each question has only one correct answer. If you mark more than one circle in any answer row, that question will be scored as incorrect.

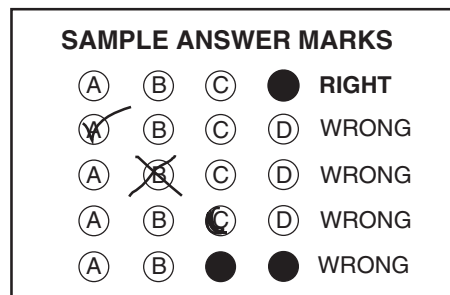

- You can use your test booklet or the provided scrap paper to take notes or solve questions; however, your answers must be recorded on the answer sheet in order to be counted.
- **You will not be able to mark your answers on the answer sheet after time is up, and answers left in the test booklet will not be scored.**

Planning Your Time

- You have 180 minutes to complete the entire test. **How you divide the time between the English Language Arts and Mathematics sections is up to you.**
- If you begin with the English Language Arts section, you may go on to the Mathematics section as soon as you are ready. Likewise, if you begin with the Mathematics section, you may go on to the English Language Arts section as soon as you are ready.
- Be sure to read the directions for each section carefully.
- Each question has only one correct answer. Choose the best answer for each question.
- When you finish a question, go on to the next, until you have completed the last question or run out of time.
- Your score is determined by the number of questions you answer correctly. **Answer every question, even if you may not be certain which answer is correct.**
- Don't spend too much time on a difficult question. Come back to it later if you have time.
- If you complete the test before the test time (180 minutes) is over, you may go back to review questions in either section.
- Students must stay for the entire test session (180 minutes).

DO NOT OPEN THIS BOOKLET UNTIL YOU ARE TOLD TO DO SO



A



Copyright © 2022 Pearson. All rights reserved. No part of this document may be copied, reproduced, modified, or transmitted by any means, electronic or mechanical.

PART 1 — ENGLISH LANGUAGE ARTS

57 QUESTIONS

REVISING/EDITING

QUESTIONS 1-16 (PART A AND PART B)

REVISING/EDITING PART A

DIRECTIONS: Read and answer the following questions. You will be asked to recognize and correct errors so that the sentences or short paragraphs follow the conventions of standard written English. You may write in your test booklet as needed to take notes. You should reread relevant parts of the sentences or paragraphs, while being mindful of time, before marking the **best** answer for each question.

1. Which revision corrects the error in sentence structure in the paragraph?

The land on Earth has not always been separated into the seven continents, at one time a massive supercontinent, known as Pangaea, covered one-third of Earth's surface. Additionally, the supercontinent was surrounded by ocean waters called Panthalassa, much of which were in Earth's Southern Hemisphere. Geologists believe that the supercontinent split apart over millions of years because of the movement of the tectonic plates that form Earth's crust. In fact, experts predict that over the next 250 million years the movement of the plates will cause the seven continents to merge into a supercontinent again.

- A. continents. At
- B. surface; additionally,
- C. Panthalassa. Much
- D. crust, in fact,

2. Read this sentence.

The Appalachian Trail is a really long trail that a lot of people do each year.

Which revision of the sentence uses the **most** precise language?

- E. The Appalachian Trail is an extremely long trail that millions of people do each year.
- F. The Appalachian Trail is a 2,200-mile trail that more than a million people hike each year.
- G. The Appalachian Trail is a 2,200-mile trail that two million people hike each year.
- H. The Appalachian Trail is a lengthy trail that a couple million people do each year.

3. What is the **best** way to combine these sentences to clarify the relationship between ideas?

- (1) The International Space Station has been inhabited by crew members since 2000.
- (2) Tourists will soon be allowed to pay for visits to the space station.
- (3) Because the cost is \$52–\$58 million round trip, few people will be able to take advantage of the opportunity to have a vacation in outer space.

- A. The International Space Station has been inhabited by crew members since 2000, but tourists will soon be allowed to pay for visits to the space station, which cost \$52–\$58 million round trip, so few people will be able to take advantage of the opportunity to have a vacation in outer space.
- B. The International Space Station has been inhabited by crew members since 2000 and will soon allow tourists to pay for visits, but because the cost is \$52–\$58 million round trip, few people will be able to take advantage of the opportunity to have a vacation in outer space.
- C. The International Space Station has been inhabited by crew members since 2000, but tourists will soon be allowed to pay for visits to the space station, though the cost is \$52–\$58 million round trip, so few people will be able to take advantage of the opportunity to have a vacation in outer space.
- D. The International Space Station has been inhabited by crew members since 2000, and tourists will soon be allowed to pay for visits to the space station because the cost is \$52–\$58 million round trip, therefore few people will be able to take advantage of the opportunity to have a vacation in outer space.

4. Which edit should be made to correct this sentence?

In 1962 the agile athletic Wilt Chamberlain became the first and only professional basketball player in the United States to score 100 points in a single game.

- E. Insert a comma after **agile**.
- F. Insert a comma after **first**.
- G. Insert a comma after **only**.
- H. Insert a comma after **States**.

5. Which revision corrects the error in sentence structure in the paragraph?

In 1967 Katherine Switzer signed up for the Boston Marathon using her first and middle initials instead of her full name, at that time, only men were permitted to officially register and receive a number for the legendary race. Once officials realized a woman was attempting to run in the race, they made efforts to remove her from the competition. Switzer prevailed and finished in just over four hours, paving the way for the official rule change that allowed for the inclusion of women. In 2017, to mark the fiftieth anniversary of this pioneering event, a seventy-year-old Switzer repeated her run, wearing the number 261, the same number she had worn in that first run in 1967.

- A. name. At
- B. race. They
- C. hours. Paving
- D. 261. The

CONTINUE TO THE NEXT PAGE ►

REVISING/EDITING PART B

DIRECTIONS: Read each of the following two texts and answer the related questions. You will be asked to improve the writing quality of each text and to correct errors so that the texts follow the conventions of standard written English. You should reread relevant parts of each text, while being mindful of time, before marking the **best** answer for each question.

Cracking the Code

(1) Computer code is part of every electronic interaction, from video games to home thermostats to vehicle GPS systems. (2) Code is a language that computers can interpret, and programmers use it to instruct computers to perform different tasks, such as finding, sorting, or calculating data. (3) People who code have to learn this language. (4) They can construct programs that will perform detailed tasks. (5) The programs can also perform complex tasks.

(6) A coding language uses letters, numbers, and symbols that are arranged in a way that makes sense to a computer. (7) The code that makes up a program tells a computer how to process information. (8) Studying a coding language involves learning the rules for combining phrases and instructions so that they are recognizable to the computer. (9) Once a person understands coding rules, the possibilities for applying them are infinite.

(10) Coding skills are becoming important in many occupational fields. (11) For example, code can be used to create programs to track, analyze, and predict changes in the stock market. (12) Code can also be designed to help doctors track and monitor a patient’s health. (13) Jobs that require coding skills are typically higher paying, offering salaries that are up to as much as \$22,000 a year more than jobs that do not require coding knowledge.

(14) People have a variety of opportunities to learn how to code. (15) In some schools, young people can study computer science and coding just as they study foreign languages. (16) Computer science teachers can use websites and apps that employ games designed to help everyone understand how code works. (17) Even high school students who do not take computer science can learn coding by attending coding workshops and online classes or by watching tutorials online. (18) After studying the basics of coding, some students may become interested in learning how to create programs, such as games and apps.

(19) The late Steve Jobs, a pioneer in computer technology, once said, “Everybody in this country should learn how to program a computer . . . because it teaches you how to think.” (20) Learning to code can seem challenging, but one does not need to become an expert programmer to reap the benefits of understanding this language.

6. What is the **best** way to combine sentences 3 through 5 to clarify the relationship between ideas?
- E. People who code have to learn this language because they can construct programs that will perform detailed and complex tasks.
 - F. People who code have to learn this language so they can construct programs that will perform detailed or complex tasks.
 - G. When people who code have to learn this language, it is so they can construct programs that will perform detailed and complex tasks.
 - H. If people who code have to learn this language, then they can construct programs that will perform detailed as well as complex tasks.
7. Which sentence should follow sentence 5 to **best** state the main claim in the passage?
- A. People should take advantage of opportunities to study and learn basic coding because of its many valuable benefits.
 - B. People should attempt to understand how code can be used to design programs that are beneficial for a variety of industries and businesses.
 - C. Schools should offer coding classes because knowing how to code will help students succeed in many types of businesses.
 - D. Students should prepare for the future job market by studying code and learning how to code programs.
8. Which revision of sentence 10 provides the **best** transition to the argument in the third paragraph (sentences 10–13)?
- E. Learning a coding language may be difficult, but coding skills are becoming important in many occupational fields.
 - F. Learning a coding language is useful because coding skills are becoming important in many occupational fields.
 - G. Employers in most industries realize that people with coding skills can demand higher salaries in many occupational fields.
 - H. Even though programming is its own unique field, coding skills are becoming important in many occupational fields.

9. Which sentence would **best** follow sentence 13 and support the ideas in the third paragraph (sentences 10–13)?
- A. Experienced programmers, software engineers, and system administrators at large companies can earn well over \$100,000 a year.
 - B. Hospitals, physicians’ offices, and pharmaceutical companies are frequently looking to hire people who code to help with a variety of tasks.
 - C. Many companies are eager to hire employees who have experience in a specific industry as well as knowledge of basic coding.
 - D. According to a report from a job market analytics firm, almost half of today’s jobs paying more than \$58,000 a year call for some level of coding ability.
10. Which concluding sentence would **best** follow sentence 20 and support the argument presented in the passage?
- E. People should understand that knowing how to code is becoming an essential requirement for most high-paying jobs.
 - F. By understanding basic coding concepts, people can participate in an increasingly digital job market.
 - G. Students who want to secure a high-paying job in the technology industry should become proficient in coding.
 - H. Since coding is a valuable marketplace skill, today’s students should begin to write their own computer programs.

CONTINUE TO THE NEXT PAGE ►

Martial Arts for the Mind and Body

(1) The martial arts blend a series of physical movements with strategic mental discipline so that practitioners can defend themselves, physically defeat an opponent, or both. (2) Historians are unsure of exactly when and where martial arts were first used. (3) Martial arts have been practiced by several different societies for many centuries. (4) Martial arts such as karate, kung fu, tae kwon do, and judo are still taught and practiced as methods of self-defense, but they offer students more than that. (5) The study of martial arts can provide students with a way to enhance their mental discipline as well as their physical fitness.

(6) Discipline, focus, and respect are important qualities for everyone to have. (7) However, for most people these qualities are not innate; they must be learned and practiced. (8) The study of martial arts can provide an opportunity to develop these skills. (9) Students are rewarded for their dedication by passing tests and advancing to higher ranks or levels. (10) For example, in a typical tae kwon do class, students learn discipline by diligently practicing moves, improve focus by listening carefully, and demonstrate respect by bowing to the instructor and following directions.

(11) For teenagers, martial arts classes provide a safe and structured environment for gaining physical skills, building confidence, and enjoying a sense of community. (12) A lot of teens go through hard situations as they try to do well in school and in life. (13) A martial arts class can provide teens with a physical outlet for stress while also challenging them mentally.

(14) Participating in a martial arts program also helps children and teens focus on self-improvement rather than on competition. (15) Progressing through levels of achievement involves mastering more physically demanding techniques. (16) It requires students to take responsibility and be accountable for achieving set goals. (17) Students gain confidence and experience companionship with other students who are progressing through the ranks.

(18) Adults who practice martial arts can experience many of the same benefits that younger people do, but perhaps the greatest of these is health and fitness. (19) Adult martial arts students often see changes in their body within weeks of beginning a program.

(20) For people interested in studying a martial art, there are many ways to learn and practice.

(21) In addition to private studios, community recreation centers often offer low-cost or free martial arts classes. (22) There are even online videos that introduce students to the basic concepts.

(23) People should study martial arts.

11. What is the **best** way to combine sentences 2 and 3?

- A.** Historians, who are unsure of exactly when and where martial arts were first used, know that martial arts have been practiced by several different societies for many centuries.
- B.** While historians are unsure of exactly when and where martial arts were first used, they do know that martial arts have been practiced by several different societies for many centuries.
- C.** Because historians know that martial arts have been practiced by several different societies for many centuries, they are unsure of exactly when and where martial arts were first used.
- D.** Martial arts have been practiced by several different societies for many centuries, and historians are unsure of exactly when and where martial arts were first used.

- 12.** Where should sentence 10 be moved to improve the organization of the second paragraph (sentences 6–10)?
- E.** to the beginning of the paragraph (before sentence 6)
 - F.** between sentences 6 and 7
 - G.** between sentences 7 and 8
 - H.** between sentences 8 and 9
- 13.** Which revision of sentence 12 **best** maintains the formal style established in the passage?
- A.** A lot of teens have to put up with difficult things while trying to do well in school and in life.
 - B.** Many teenagers deal with tough situations as they try to stay on top of their studies and do well in life.
 - C.** Many teenagers encounter challenges as they work to succeed both academically and personally.
 - D.** A lot of teens face problems as they work to keep up with their schoolwork and find personal success.
- 14.** Which transitional phrase should be added to the beginning of sentence 17?
- E.** Over time,
 - F.** In fact,
 - G.** Even so,
 - H.** For instance,

15. Which sentence would **best** follow and support sentence 18?
- A. Adult students gain discipline, focus, self-control, and respect, which are qualities that help them advance in their careers.
 - B. Many adults initially train in a martial art simply to get exercise without realizing that the training also helps develop other skills.
 - C. The exercise involved in training helps people strengthen their heart, boost endurance, improve balance, and develop muscle tone.
 - D. People who commit to training in the martial arts are usually concerned about improving their overall physical health.
16. Which concluding sentence should replace sentence 23 to **best** support the topic presented in the passage?
- E. With so many ways to begin studying martial arts, people can easily discover how the skills needed to progress in rank may help them in life.
 - F. By taking advantage of opportunities to practice martial arts, people can experience the satisfaction of achieving goals while also improving themselves.
 - G. Because people are eager to reap the mental and physical benefits of studying martial arts, enrollment in martial arts courses has increased.
 - H. While taking martial arts classes can improve health for both young people and adults, the effects are clearly more immediate for adults.

READING COMPREHENSION

QUESTIONS 17–57

DIRECTIONS: Read each of the following six texts, and answer the related questions. You may write in your test booklet as needed to take notes. You should reread relevant parts of each text, while being mindful of time, before marking the **best** answer for each question. Base your answers only on the content within the text.

CONTINUE TO THE NEXT PAGE ►

Excerpt from “Scribe Like an Egyptian”

by Hilary Wilson

- 1 In ancient Egypt, literacy was the key to success. However, contrary to popular belief, not all Egyptian scribes understood hieroglyphs. Many relied instead on the simpler hieratic script for the multitude of everyday documents generated by the Egyptian bureaucracy.¹
- 2 Hieroglyphs—“the Words of God”—compose a writing system with more than 1,000 distinct characters, the meanings of which were lost for 1,500 years before they were deciphered by Jean-François Champollion in 1822. Including both ideograms (which convey a whole word or idea, either concrete or abstract, in a single sign) and phonograms (representing either an alphabetic sound or a group of consonants), [the writing system] was used in formal inscriptions on tomb and temple walls as well as on elaborate funerary papyri.² For everyday purposes, however, scribes used a shorthand version of the hieroglyphic script known as hieratic, which was quicker to write and more economical of space. The two writings existed side by side for at least 2,500 years.
- 3 Scraps of ancient hieratic writing, mostly penned by student scribes on limestone flakes called ostraca, suggest that no matter how humble his origins, an educated Egyptian could achieve almost anything. Horemheb (d.1292 B.C.) is a good example. Born of middle-ranking parents, his scribal training led to an army career. From Scribe of Recruits, during the reign of Akhenaten (1353–1336 B.C.), Horemheb rose through the military ranks and, by the rule of Tutankhamun (1332–1323 B.C.), he was commander in chief of the Egyptian forces. As a close adviser of the young Pharaoh, Horemheb was appointed “Deputy of the King throughout the Two Lands,” and might have expected to succeed to the throne should the king die childless. He had to wait a few years, but eventually Horemheb achieved the pinnacle of his career by becoming the last king of the 18th Dynasty, making his mark by instituting dramatic reforms to the organization of the army, the judiciary and administration in general. The lasting success of these changes owed much to his scribal background. . . .
- 4 But education was not available to all. Government departments and major temples supported schools, where boys commenced their training at six or seven, sometimes earlier. To these boarding establishments . . . family or household servants delivered the students’ food and drink rations daily for several years, during which time the student was not contributing to the family’s income. Boys from poorer families could only hope to be educated with support from a wealthier relative or patron, or through apprenticeship to an older scribe, perhaps the local clerk or land agent, who would teach them the basics of the scribe’s craft. This limited the scope for employment but such “on the job” training allowed apprentices to help out at home while learning. . . .
- 5 Scribal education began with the elementary principles of the hieratic script. The lowliest scribes, who trained for just five or six years, probably learned only the rudiments³ of the hieroglyphic

¹**bureaucracy:** an administrative staff of government officials

²**funerary papyri:** a sheet or scroll of papyrus containing religious images and hieroglyphs meant to help the deceased be reborn in the afterlife

³**rudiments:** basics

script. Students were set exemplar documents and extracts from popular texts to copy, to practice their hieratic handwriting on basic-format letters, reports and contracts, while absorbing the good advice contained in the texts. Surviving examples of copy-work sometimes include tutors' corrections added in red. Some significant Egyptian literary works survive almost exclusively from student copies.

- 6 A schoolboy⁴ "dictionary" of hieroglyphs with their hieratic equivalents shows that a knowledge of more than 450 signs was required for everyday writing purposes. Lessons in record-keeping and filing and labelling enabled any half-competent scribe to perform that most essential of all scribal functions: the making and updating of lists. For professions such as those of government official, priest or lawyer, a scribe would train for several more years, increasing his vocabulary to perhaps a thousand or more signs. Those with the best handwriting or drawing skills might follow the craft of creating beautifully illustrated copies of funerary texts, commonly called *Books of the Dead*. Others could become draughtsmen⁵, artists or architects. Doctors compiled their own collections of medication recipes, treatments and associated incantations, many copied from texts found in the House of Life, the temple library. Lawyers had to be familiar with the corpus⁶ of civil and religious laws and precedents found in the official records, which were administered by archivists. Egypt's bureaucratic society depended on the skills of an army of scribes of all ranks from filing clerk to tax assessor. For young Egyptians, "be a scribe" was the best of career advice.

From "Scribe Like an Egyptian" by Hilary Wilson from HISTORY TODAY, August 8, 2019. Copyright © 2019 by History Today Ltd. Company.

⁴**schoolboy:** slang that refers to materials used during the course of receiving an education

⁵**draughtsmen:** a person who draws plans of machinery or structures

⁶**corpus:** a collection of writings

ANCIENT EGYPTIAN
SOCIAL CLASS STRUCTURE

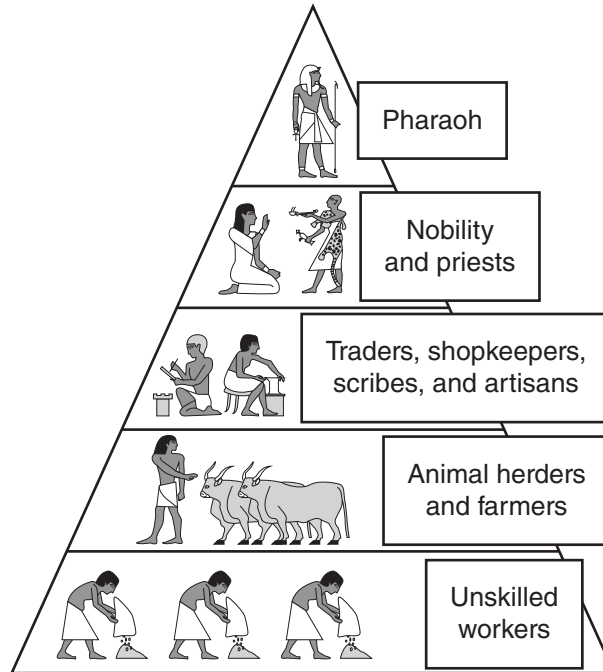

17. Which sentence from the excerpt **best** supports the idea that there were different levels of education for a scribe?
- A. "However, contrary to popular belief, not all Egyptian scribes understood hieroglyphs." (paragraph 1)
 - B. "For everyday purposes, however, scribes used a shorthand version of the hieroglyphic script known as hieratic, which was quicker to write and more economical of space." (paragraph 2)
 - C. "This limited the scope for employment but such 'on the job' training allowed apprentices to help out at home while learning." (paragraph 4)
 - D. "For professions such as those of government official, priest or lawyer, a scribe would train for several more years, increasing his vocabulary to perhaps a thousand or more signs." (paragraph 6)

18. Read this sentence from paragraph 2.

Including both ideograms (which convey a whole word or idea, either concrete or abstract, in a single sign) and phonograms (representing either an alphabetic sound or a group of consonants), [the writing system] was used in formal inscriptions on tomb and temple walls as well as on elaborate funerary papyri.

The author’s purpose for including the sentence is to

- E. explain that hieroglyphs were reserved for royal and religious purposes.
- F. demonstrate the methods experts use to interpret hieroglyphs.
- G. clarify the significance of hieroglyphs in language and literature.
- H. describe the basic features of hieroglyphs and how they were typically used.

19. Which statement summarizes the process that schools used to train scribes?

- A. Boys had to memorize around 450 hieratic signs. Once they had learned these, they were expected to copy literary texts that contained valuable lessons.
- B. Boys spent at least five years learning hieratic signs, which they practiced by copying texts. During this period, they were also introduced to basic hieroglyphs.
- C. Boys spent five or six years learning the basics of hieratic script. After this period, they could become apprentices and begin learning hieroglyphics.
- D. Boys were taught two different scripts. They practiced both types by copying lists and eventually progressed to writing letters, reports, and contracts.

20. Which claim is **best** supported by the information presented in paragraphs 3 and 4?

- E. Education was difficult for the common citizens of Egypt to obtain.
- F. Once students began studying to become scribes, their future held more possibilities.
- G. If someone wanted to become a scribe, support from outside sources such as the government or a temple was necessary.
- H. Becoming a successful scribe required a student’s family to sacrifice time and money in order to ensure the best education.

21. Hieratic script was particularly valuable in a bureaucratic government because
- A. using hieratic script was an efficient way for scribes to produce large amounts of documentation.
 - B. many members of the general public could comprehend information that was written in hieratic script.
 - C. knowledge of hieratic script prepared scribes to serve their society in increasingly challenging roles.
 - D. people from different professional backgrounds could easily communicate with one another in hieratic script.
22. The diagram after paragraph 6 **best** provides additional support for the topic of the excerpt by
- E. demonstrating the place of scribes in ancient Egyptian social structure.
 - F. depicting the types of tasks performed by each social class.
 - G. indicating that scribes were able to easily improve their social ranking.
 - H. comparing the social positions of each social class in ancient Egypt.
23. Based on the excerpt, which statement would the author **most** strongly agree with?
- A. Boys in Egypt were encouraged to enter the same profession as older male relatives.
 - B. Knowledge of hieroglyphs was helpful to Egyptians who were interested in becoming scribes.
 - C. Hieratic script was more practical to ancient Egyptians than hieroglyphs were.
 - D. Boys in Egypt who studied for only a few years were unlikely to find employment as scribes.

CONTINUE TO THE NEXT PAGE ►

This narrative is about the Nez Perce, an American Indian tribe, in what is now northern Idaho. The tribe is preparing for a gathering before the coming winter.

Excerpt from *Do Them No Harm!*

by Zoa L. Swayne

- 1 In the moon of Ta-Yum, the hottest days of summer, when salmon spawn in the little streams and huckleberries ripen in the high mountains, people from many villages of the Chopunnish Nation gathered in the Oyaip Prairie for the work and festivities of their annual camas¹ harvest.
- 2 From far and near The People came. . . .
- 3 Should a stranger enter their homeland and ask, “Where are you from?” the reply was always, “We are Nee-mee-poo, The People who live here in this place.”
- 4 It was a time of Lawtiwa-mah-ton—a time of being friends together—when The People came for this last chance to enjoy being together before the Cold Moons kept them close to their fires. The visiting and trading, the foot racing and horse racing, and the gambling and stick games would be remembered and talked about long after they had forgotten the drudgery of digging and roasting camas, picking berries, or drying meat and fish. Lawtiwa-mah-ton! It was good to be friends together.
- 5 As was their custom since wahk-kee-ma, a time far back beyond the memory of man, they set up their camps in the same locations their parents and grandparents had occupied before them. Red Bear’s people, from Kamiah, made their camp near the trail that came out of the mountains. Their neighbors in Kamiah Valley, The People from Tee-e-lap-a-lo, had their camp close by. Across the wide meadow, by the great roasting pits, the camps of the Te-wap-poo and Ask-kah-poo were located. The tepees and ish-nash, brush shelters, of other groups nestled in their accustomed areas in and among the pines in such numbers that they encircled the entire meadow land.
- 6 Red Bear’s people had traveled all summer with neighboring bands, gathering and preparing roots, picking and drying berries, drying and smoking meat and fish for their winter food supply. Now they were at the Oyaip camp. The women worked hard to dig and cure as many bags of roots as they could during the warm, sunny days, for the sharp night air brought warnings that WARM was going and COLD was coming.
- 7 Everyone helped in some way. Most of the men fished or hunted for meat. While many of the women dug and roasted camas, other women and older children picked and dried berries.
- 8 And the younger children played. They played at hunting. They played with the babies. They played with their horses and puppies. They learned how to live through their play.
- 9 This sun, happiness, peace, and quiet blessed the Red Bear camp. All were busy with their daily tasks, until sudden cries came from the children playing by the trail.

¹**camas:** a wild, edible plant

- 10 "People coming! People coming! People coming on the trail from the high mountains!" they called as they ran to their elders, who looked sharply at the figures of approaching horsemen.
- 11 Were they friends or enemies? Did they bring good news or bad?
- 12 "Who can it be? What brings them here?" were the questions in every mind.
- 13 "Could they be the four hunters who had gone to Buffalo Country two summers past? Would they have news of the families who had gone long ago to Buffalo Country and never returned?"
- 14 It was customary for a hunting party to be gone for more than one season.
- 15 "Looks like hunters," the older men agreed. "Looks like they had good hunting. Maybe our four hunters. [They have] been gone many moons."
- 16 "Looks like five people—not four," others observed.
- 17 Excitement grew as the riders came close enough to be recognized.
- 18 "A-a-a-a, they are our four hunters! But who is the fifth person?" they asked.
- 19 "Looks like a woman. Who is she?"
- 20 The hunters rode up to the welcoming crowd, proud to show off the loads of meat, hides, and other trophies of their hunt. They paraded around the encampment for all to see how strong their Hunting Power had been—what great hunters they, themselves, were.
- 21 Red Bear's people rejoiced at their hunters' success. Good hunters brought good to everybody. The meat meant plenty of food and the hides meant soft-tanned robes to give comfort through the Cold Moons. But it was the sight of the frail figure of the woman that aroused their curiosity. Who was she? Where had she come from? . . .
- 22 "Belongs to Red Bear people. Gone then come back," the hunters said, as they dismounted and unloaded their packs. . . .
- 23 Now they could see! She was the daughter of the family gone so long ago! The girl-child who had left came back now—a grown woman.
- 24 "Wat-ku-ese!" the women cried. "Gone-from-Home-then-Come-Back. Wat-ku-ese!" And Wat-ku-ese was her name from that time on.
- 25 Gentle arms lifted Wat-ku-ese from her horse. The women brought her food and made a place for her to rest. For many suns they cared for her until she became stronger.
- 26 One evening Wat-ku-ese told her story for all to hear.

From DO THEM NO HARM!: Lewis and Clark Among the Nez Perce by Zoa L. Swayne. Published by Caxton Press. Copyright © 1990 by Zoa L. Swayne Orofino, Idaho and Legacy House, Inc. Orofino, Idaho. All rights reserved.

24. Paragraph 1 contributes to the setting of the excerpt by establishing that
- E. the story’s location is a plentiful place that allows The People to enjoy a comfortable gathering.
 - F. the events in the story occurred in the past and are being remembered by The People.
 - G. the camp in the story is changing and that the changes are causing problems for The People.
 - H. the story’s plot begins as The People are observing their land and what it offers them.
25. In paragraphs 4 and 6, the beginning of the change in seasons affects the characters mainly by
- A. causing them to collect their bounty and feel eager to celebrate before it becomes cold.
 - B. making them want to rest and relax before the challenging work of the harvest begins.
 - C. forcing them to give up leisure time to prepare their camp for the coming winter.
 - D. allowing them to trade the goods they have prepared during the warm months.
26. How do paragraphs 7 and 9 convey a central idea of the excerpt?
- E. by explaining that The People often explore different areas, which shows the value of trying new things
 - F. by revealing that The People must complete many tasks, which shows the necessity of being organized
 - G. by suggesting that The People are influenced by the weather, which shows their close relationship with nature
 - H. by demonstrating that The People work together, which shows the importance of contributing to the community
27. In paragraph 8, the author repeats the word “played” **most likely** to
- A. emphasize how much the adults enjoy observing the children.
 - B. show how everyone finds a way to enjoy being at the gathering.
 - C. indicate the variety of activities available at the gathering.
 - D. characterize the manner in which the children master the work of adults.

- 28.** How do paragraphs 11–13 affect the plot of the excerpt?
- E.** They establish a feeling of mystery by presenting different points of view about the arriving people.
 - F.** They contribute to the rising action by developing the idea that the arriving people could present a problem.
 - G.** They lead to a turning point by describing the moment that the crowd realizes why the strangers have come.
 - H.** They explain the cause of the main conflict by providing background information about the strangers.
- 29.** In paragraph 20, the phrases “trophies of their hunt” and “paraded around” affect the paragraph by
- A.** suggesting that the hunters are rewarded for their leadership.
 - B.** emphasizing that The People are dependent on the hunters for food.
 - C.** revealing that the hunters are pleased with their success.
 - D.** indicating that The People have gathered specifically to welcome the hunters.
- 30.** Which quotation from the excerpt **best** supports the idea that The People maintain a connection to members of their group in spite of distance?
- E.** “As was their custom since wahk-kee-ma, a time far back beyond the memory of man, they set up their camps in the same locations their parents and grandparents had occupied before them.” (paragraph 5)
 - F.** “ ‘Would they have news of the families who had gone long ago to Buffalo Country and never returned?’ ” (paragraph 13)
 - G.** “ ‘Looks like hunters,’ the older men agreed. ‘Looks like they had good hunting.’ ” (paragraph 15)
 - H.** “But it was the sight of the frail figure of the woman that aroused their curiosity.” (paragraph 21)

Excerpt from “The Food Business Incubator”

by Mandalit Del Barco

- 1 “La Cocina” means “the kitchen” in Spanish. It’s also the name of a business incubator¹ based in San Francisco’s Mission District. Since it began in 2005, it’s been helping local food entrepreneurs, many of whom are low-income immigrant women, develop their small businesses.
- 2 Over the years, many of its alumni have found success: more than 50 chefs in its program have become self-sufficient business owners, and many of them have opened their own brick-and-mortar restaurants. Two alumnae of its culinary program . . . were even recognized as semi-finalists for prestigious James Beard awards.²
- 3 A new cookbook, *We Are La Cocina: Recipes in Pursuit of the American Dream*, tells some of their stories.
- 4 Executive director Caleb Zigas says the nonprofit La Cocina grew out of two grassroots economic development organizations³ who found many people cooking at their homes and selling food on the streets. The vendors needed an affordable commercial kitchen space and technical assistance in order for their businesses to be legally viable. La Cocina provided just such a space, in addition to helping them develop business plans, pull city permits and more.
- 5 Zigas says as many as eight businesses can work in the kitchen space at La Cocina at any one time. Some can prep for a farmers’ market sale, corporate catering gigs or weddings, while others might be making and packaging their food products.
- 6 “It’s just an incredible and exciting range of techniques, flavors, perspectives, age, language. And that’s a really beautiful thing,” he says. . . .
- 7 Twice a year, La Cocina hosts “F&B: Voices from the Kitchen,” a storytelling project where their chefs can tell their own stories, as they do in the new cookbook. Some of the chefs will be on tour to promote the book, whose proceeds will go to support La Cocina entrepreneurs.
- 8 NPR⁴ caught up with . . . La Cocina chefs, who shared their stories:

Mariko Grady, Aedan Fermented Foods

- 9 At La Cocina, you can often hear Mariko Grady singing or humming as she prepares miso, *koji*, and *amasake*. Her fermented products come in four different flavors, including mushroom and chicken, to be used in soups and sauces. She originally brought the fermenting rice and barley

¹**business incubator:** company that helps new and startup companies develop by providing services such as management training and office space

²**James Beard awards:** an award named after American cook and author James Beard, considered one of the highest honors in the culinary industry

³**economic development organizations:** organizations whose mission is to promote economic improvement within a specific geographical area

⁴**NPR:** National Public Radio, a nonprofit media organization that produces and distributes news and cultural programming

koji seeds from Japan, where she had a 30-year career as a singer and dancer with the prestigious modern theatrical dance group she founded, Pappa Tarahumara. They performed around the world, and 16 years ago, had a one-night show in San Francisco. The man who would become her husband was in the audience. She soon joined him in San Francisco, often returning to Tokyo to rehearse. But after the earthquake and tsunami hit Japan in 2011, her company disbanded. . . . Grady focused on nourishing her family and creating a line of fermented products that she sells online, at local Bay Area stores and at the Ferry Plaza Farmers Market. She began at La Cocina in 2012 and named her business after her son, Aedan. (Written in Kanji characters, the name means “wisdom” and “handed down from generation to generation.”) . . . Her fermented products are “also full of wisdom about how to relate to nature and how to create a healthy life,” she says. . . .

Shani Jones, Peaches Patties

- 10 Shani Jones is a native San Franciscan. Her father was born in New Orleans, her mother, in Jamaica. She says their home was always filled with a variety of spices and dishes like jerk chicken and Jamaican patties—savory pastries filled with beef or chicken. Jones says she learned to cook from her mother, whose nickname was Peaches. After returning from college in Atlanta, Jones worked on her doctorate in organizational leadership and management while driving a Lyft⁵ car. She often told passengers about her idea of opening a catering company with her mom’s recipes. They steered her to La Cocina, where she developed her own business, named after her mother. Five years later, she caters and runs a kiosk⁶ at a small food cooperative in Bernal Heights, where some of her handmade patties have an Ethiopian twist, “because my husband is Ethiopian.” Jones has big aspirations for Peaches Patties: “The ultimate goal,” she says, “is to be the patty kingpin⁷ of the West Coast.”

From “The Food Business Incubator That Helps Immigrant Women Pursue The American Dream” by Mandalit Del Barco from WEEKEND EDITION SUNDAY, June 19, 2019. Copyright © 2019 NPR.

⁵**Lyft:** ride-sharing company where people use their own cars to provide rides to customers

⁶**kiosk:** cart or small structure with one or more open sides that is used to vend merchandise or services

⁷**kingpin:** the leader in a group or undertaking

QUALIFICATIONS FOR LA COCINA APPLICANTS

Level of Income	La Cocina considers assets and access to opportunity when screening applicants. La Cocina’s mission is to support entrepreneurs who face barriers to becoming successful in the food industry. Applicants must be classified as low- or very-low-income earners according to the Housing and Urban Development (HUD) Guidelines for San Francisco.
Business Plan	Applicants must have a business plan that is ready to be put into action. La Cocina will help applicants refine an existing business plan. Applicants without a business plan should contact one of La Cocina’s partner organizations for guidance in developing one.
Viable Product	The applicant’s food must not only be delicious but also stand out. For a business to make a profit, there also has to be a market for the food.
Entrepreneurial Work Ethic	La Cocina is excited to work with entrepreneurs who are motivated and passionate about growing their business. Succeeding in the food industry requires a lot of heart and hard work.
Community Spirit	The 30+ entrepreneurs who share La Cocina’s kitchen are from many different backgrounds. La Cocina values the community it has created and expects each entrepreneur to be active in bringing the spirit of La Cocina to the wider world. In order to succeed in the La Cocina kitchen, accepted applicants must be flexible and willing to work closely with others.

Source: La Cocina

31. Read this sentence from paragraph 2.

Two alumnae of its culinary program . . . were even recognized as semi-finalists for prestigious James Beard awards.

The words “recognized” and “prestigious” in the sentence convey that La Cocina

- A.** makes an effort to identify chefs who have a strong entrepreneurial work ethic.
- B.** has the ability to mentor chefs to reach the highest levels of achievement in their craft.
- C.** is focused on establishing local food entrepreneurs as celebrated professionals in their industry.
- D.** is dedicated to assisting chefs in developing new and innovative products.

- 32.** Paragraph 4 contributes to the development of ideas about La Cocina in paragraph 1 by
- E.** specifying how La Cocina helps local food entrepreneurs become successful.
 - F.** explaining what kind of goals La Cocina tries to set for local food entrepreneurs.
 - G.** providing background information about local food entrepreneurs in San Francisco.
 - H.** describing how Caleb Zigas discovered the need to provide assistance to local food entrepreneurs.
- 33.** The description of Mariko Grady’s background in paragraph 9 contributes to a central idea in the excerpt by
- A.** demonstrating what people are looking for when they come to La Cocina.
 - B.** explaining why La Cocina is the best option for people starting out in the food business.
 - C.** showing how La Cocina can help people find success in the food business even though they have a background in something different.
 - D.** confirming that La Cocina was originally established for small business owners who are looking to expand their services.
- 34.** Which statement would the author **most likely** agree with?
- E.** The publicity efforts La Cocina engages in will help its business design spread to other cities.
 - F.** The variety of exciting food available in San Francisco is due to the work of La Cocina.
 - G.** La Cocina offers a method that will guarantee business ownership for qualified entrepreneurs.
 - H.** La Cocina does admirable work in supporting the efforts of ambitious cooks who may have few resources.

- 35.** Which detail would be **most** important to include in a summary of the excerpt?
- A.** La Cocina produced a cookbook that includes some members' stories.
 - B.** La Cocina provides legal and technical assistance to its members.
 - C.** Potential vendors need a market for their food before considering La Cocina.
 - D.** There are different types of venues that food vendors from La Cocina use.
- 36.** The table provides additional support for a central idea of the excerpt by
- E.** showing how La Cocina works with partner organizations to further educate and advance successful applicants within the food industry.
 - F.** explaining how applicants are prepared to develop their own businesses once they leave La Cocina.
 - G.** establishing that La Cocina is dedicated to its mission to provide delicious food to different communities.
 - H.** emphasizing that applicants must be willing to dedicate time to promoting and developing their business with La Cocina.

CONTINUE TO THE NEXT PAGE ►

Excerpt from “The Past and the Future of the Earth’s Oldest Trees”

by Alex Ross

- 1 About forty-five hundred years ago, not long after the completion of the Great Pyramid at Giza, a seed of *Pinus longaeva*, the Great Basin bristlecone pine, landed on a steep slope in what are now known as the White Mountains, in eastern California. The seed may have travelled there on a gust of wind, its flight aided by a winglike attachment to the nut. Or it could have been planted by a bird known as the Clark’s nutcracker, which likes to hide pine seeds in caches; nutcrackers have phenomenal spatial¹ memory and can recall thousands of such caches. This seed, however, lay undisturbed. On a moist day in fall, or in the wake of melting snows in spring, a seedling appeared above ground—a stubby one-inch stem with a tuft of bright-green shoots.
- 2 Most seedlings die within a year; the mortality rate is more than ninety-nine percent. The survivors are sometimes seen growing in the shadow of a fallen tree. The landscape of the Ancient Bristlecone Pine Forest, as this area of the White Mountains is called, is littered with fragments of dead trees—trunks, limbs, roots, and smaller chunks. *Pinus longaeva* grows exclusively in subalpine regions of the Great Basin, which stretches from the eastern slopes of the Sierra Nevada to the Wasatch Range, in Utah. Conditions are generally too arid for the dead wood to rot; instead, it erodes, sanded down like rock. The remnants may harbor nutrients and fungi that help new trees grow. Bristlecones rise from the bones of their ancestors—a city within a cemetery.
- 3 Coast redwoods and giant sequoias, California’s gargantuan world-record-holding trees, can grow fifty feet or more in their first twenty years. Bristlecones rise agonizingly slowly. After four or five years, the seedling on the steep slope would have been just a few inches higher, sprouting needles in place of the embryonic shoots. The needles are a deep green, tough, resinous, and closely bunched in groups of five. On a mature tree, they live for fifty years or more. Decades may have passed before the tree was human height, and decades more before it resembled a conventional pine. Bristlecone saplings grow straight up, with relatively sparse foliage, looking like undernourished Christmas trees. After a few hundred years—by which time the Old Kingdom of Egypt had fallen—it was probably forty or fifty feet in height.
- 4 Many tree species live for hundreds of years. A smaller but not inconsiderable number, including the sequoias and certain yews, oaks, cypresses, and junipers, survive for thousands. Once a bristlecone has established itself in the unforgiving conditions of the White Mountains, it can last almost indefinitely. The trees tend to grow some distance from one another, so fires almost never destroy an entire stand. Because only a few other plant species can handle the dry, cold climate, the bristlecones face little competition. Unlike most plants, they tolerate dolomite soil, which is composed of a chalky type of limestone that is heavily alkaline and low in nutrients. As for insect threats, bristlecone wood is so dense that mountain-pine beetles and other pests can rarely burrow their way into it.
- 5 Empires rose and fell; wars raged; . . . and the tree from 2500 B.C. continued its implacable slow-motion existence, adding about two-hundredths of an inch to the diameter of its trunk each

¹**spatial:** relating to physical space

year. Minute changes in the tree-ring record make bristlecones an exceptionally useful source of data about changing conditions on Earth. When rains are heavier than normal, the rings widen. When volcanic eruptions cause global cooling, frost rings make the anomaly² visible. . . .

- 6 As the millennia go by, bristlecones become contorted and wraithlike.³ The main stem, or leader, dies back. Entire branches, even the trunk itself, become fossils. At first glance, the tree may look dead. Such is the case of the forty-five-hundred-year-old tree that clings to life near the tourist path that now runs through the Ancient Bristlecone Pine Forest. Spears of dead wood jut into the air. The trunk is a marbled hulk stripped of bark, like driftwood thrown from a vanished ocean. A ribbon of live bark runs up one side, funneling water and nutrients to clumps of green needles high above. All told, the tree is an unprepossessing specimen; most people march past it without giving it a second glance. . . .
- 7 . . . No two super-elderly trees look alike, to the point where they have acquired the characteristics of individuals. Trees are prone to anthropomorphism; we project our dreams and our anxieties onto them. Bristlecones have been called elders, sentinels, sages. The possibility that climate change will cause their extinction has inspired a spate⁴ of alarmed news stories, although tree scientists tend to discount the idea that the bristlecones are in immediate danger. They have survived any number of catastrophes in the past; they may survive humanity.

From "The Past and the Future of the Earth's Oldest Trees" by Alex Ross from THE NEW YORKER, January 20, 2020. Copyright © 2020 by Condé Nast. All rights reserved.

²**anomaly:** oddity

³**wraithlike:** ghostly

⁴**spate:** sudden abundance

- 37.** What is the effect of comparing groups of bristlecone pines to "a city within a cemetery" (paragraph 2)?
- A.** It illustrates that the new tree's appearance is markedly different from that of mature bristlecone pines.
 - B.** It emphasizes the new tree's ability to use resources left by prior generations of bristlecone pines.
 - C.** It highlights the tree's capacity for a long life if it is able to survive to maturity.
 - D.** It reveals that the tree's dense growth patterns are unusual in arid conditions.

38. In paragraph 4, the idea that the bristlecone pine can withstand difficult conditions is illustrated mainly through
- E. a comparison of the bristlecone pine with similar trees that are known for their long lives.
 - F. a description of specific qualities of the bristlecone pine that make it suited to its environment.
 - G. an explanation of why the White Mountains are the best place for the bristlecone pine to grow.
 - H. an examination of why the bristlecone pine has few competitors in the White Mountains.

39. Read this sentence from paragraph 5.

Empires rose and fell; wars raged; . . . and the tree from 2500 B.C. continued its implacable slow-motion existence, adding about two-hundredths of an inch to the diameter of its trunk each year.

The sentence contributes to the development of ideas in the excerpt by

- A. emphasizing the bristlecone pine’s precise growth pattern.
 - B. suggesting that things that seem well established face threats.
 - C. describing the pace of the life cycle of the bristlecone pine.
 - D. explaining the reason for the bristlecone pine’s longevity.
40. The phrases “clings to life” and “stripped of bark” in paragraph 6 are used to highlight
- E. that the tree is fragile and needs help to avoid becoming extinct.
 - F. how the tree can be misunderstood because of its appearance.
 - G. how the tree interests observers with its unusual appearance.
 - H. that the tree manages to survive even when partially fossilized.
41. The details in paragraph 7 convey a central idea of the excerpt by suggesting that
- A. the success of the bristlecone pine lies in its ability to resist climate change.
 - B. the uncommon appearance of the bristlecone pine is related to its ability to survive.
 - C. the attachment that humans have to the bristlecone pine is understandable.
 - D. the longevity of the bristlecone pine continues to encourage experts.

42. Throughout the excerpt, the author conveys his point of view mainly by
- E. sharing details about the qualities of the bristlecone pine that make it an unusual tree.
 - F. comparing the bristlecone pine to global empires that lasted thousands of years before falling.
 - G. explaining the way the seemingly sickly appearance of the bristlecone pine contrasts with its ability to survive.
 - H. arguing that the bristlecone pine has survived past threats to its survival and will continue to thrive.
43. What is the **best** summary of the bristlecone pine’s life cycle?
- A. The bristlecone pine takes root as a stubby seedling in the mountains. Over time, it grows slowly in a hostile environment with alkaline soil that ensures little competition from other trees.
 - B. The bristlecone pine grows up slowly from the fragments of its dead ancestors. Over time, it begins to become contorted in appearance but continues to funnel water and nutrients to its stem.
 - C. The bristlecone pine grows slowly in an environment hostile to other trees. Over time, its trunk and some branches fossilize, but it funnels water and nutrients to other parts that are still alive.
 - D. The bristlecone pine grows only in one location in the mountains. Over time, it develops sparse foliage that fossilizes slowly, but the trunk and branches stay alive as revealed by ribbons of live bark.

Bird Talk

by Carl Sandburg

And now when the branches were beginning to be heavy,
It was the time when they once had said, "This is the
beginning of summer."

The shrilling of the frogs was not so shrill as in the
5 first weeks after the broken winter;
The birds took their hops and zigzags a little more
anxious; a home is a home; worms are worms.
The yellow spreads of the dandelions and buttercups
reached across the green pastures.
10 *Tee whee* and *tee whee* came on the breezes, and the grackles
chuzzled their syllables.

And it was the leaves with a strong soft wind over them
that talked most of all and said more than any others
though speaking the fewest words.

15 It was the green leaves trickling out the gaunt nowhere
of winter, out on the gray hungry branches—
It was the leaves on the branches, beginning to be heavy,
who said as they said one time before, "This is the be-
ginning of summer."

20 We shall never blame the birds who come
where the river and the road make the Grand Crossing
and talk there, sitting in circles talking bird talk.

If they ask in their circles as to who is here
and as to who is not here and who used to be here,

25 Or if instead of counting up last year as against
this year, they count up this year as against next
year, and have their bird chatter about who is here
this year who won't be here next year,
We shall never blame the birds.

30 If I have put your face among leaf faces, child,
Or if I have put your voice among bird voices,
Blame me no more than the bluejays.

"Bird Talk" from THE COMPLETE POEMS OF CARL SANDBURG, published by Harcourt Brace & Company.
Copyright © 1970, 1969 by Lilian Steichen Sandburg, Trustee.

44. Read lines 6–7 from the poem.

**The birds took their hops and zigzags a little more
anxious; a home is a home; worms are worms.**

What idea from the second stanza do the lines help develop?

- E. The birds are eager for the return of warmer months.
 - F. The birds are most likely to thrive during the spring.
 - G. The birds naturally adjust to the seasonal changes.
 - H. The birds instinctively prepare for the future.
45. Read lines 12–14 from the poem.

**And it was the leaves with a strong soft wind over them
that talked most of all and said more than any others
though speaking the fewest words.**

What does the phrase “talked most of all” in line 13 convey?

- A. It establishes that the speaker thinks the sound of wind in the leaves is the best indication that the season is changing.
 - B. It introduces the idea that the sound of the wind in the leaves remains constant throughout the seasons.
 - C. It suggests that the speaker is overwhelmed by the sounds of nature that emerge as the season changes.
 - D. It emphasizes that the sounds of nature enable the speaker to appreciate each season of the year.
46. How does the repetition of “ ‘This is the beginning of summer’ ” in lines 2–3 and lines 18–19 contribute to the meaning of the poem?
- E. It suggests that the shift to summer occurs in the same way each year.
 - F. It emphasizes the idea that living things are prepared for the change of season.
 - G. It highlights the idea that the first signs of summer are surprising each year.
 - H. It builds expectations about what the natural world looks like during a change of season.

47. Which lines from the poem **best** contrast with the idea of winter’s scarcity and bleakness?
- A. “The shrilling of the frogs was not so shrill as in the / first weeks after the broken winter;” (lines 4–5)
 - B. “The yellow spreads of the dandelions and buttercups / reached across the green pastures.” (lines 8–9)
 - C. “*Tee whee* and *tee whee* came on the breezes, and the grackles / chuzzled their syllables.” (lines 10–11)
 - D. “Or if instead of counting up last year as against / this year, they count up this year as against next” (lines 25–26)
48. How do lines 23–28 contribute to a central idea of the poem?
- E. They suggest that the speaker is aware of what has been lost in the winter.
 - F. They imply that the birds sing the most in the summer.
 - G. They reveal that the birds are subject to the cycles of nature.
 - H. They emphasize that the speaker enjoys observing nature.
49. Throughout the poem, the poet conveys the speaker’s point of view by
- A. gradually moving the speaker’s attention from one element of nature to another.
 - B. providing the speaker’s motivation for describing the landscape in great detail.
 - C. highlighting the speaker’s emotional response as each season passes.
 - D. shifting the speaker’s focus from external observations to personal reflection.
50. Over the course of the poem, a central idea is developed mainly through the speaker’s
- E. sense of eager anticipation as winter ends.
 - F. description of the changes in nature as the seasons transition.
 - G. observation of the birds’ behavior as summer begins.
 - H. prediction of future alterations in the physical landscape.

CONTINUE TO THE NEXT PAGE ►

The author of this opinion article attended a symposium, or conference, in Missoula, Montana, at which biologists and other scientists discussed species of plants and animals that are not native to the areas in which they live.

Excerpt from “It’s Time to Stop Thinking That All Non-Native Species Are Evil”

by Emma Marris

- 1 Invasive species are scary. It was ecologist Charles Elton, back in the 1950s, who introduced the militaristic “invasion” metaphor to describe exotic plants and animals—but there’s no question some can be extremely destructive.
- 2 The brown tree snake has eaten a dozen kinds of forest birds in Guam to extinction; zebra mussels clog pipes around the Great Lakes; the common house cat turns out to be, in Australia, a mercilessly effective killer of cute, fluffy marsupials like the bilby and the numbat.
- 3 As scientists have sounded the alarm about these pests, the public has gotten the message. Citizen groups rip out non-native plants. Native gardens have become increasingly popular, both as ways to celebrate the unique flora of each region and as tiny hot spots of diversity. Native trees provide food for native bugs, which feed native birds. Food chains developed over thousands of years of co-evolution unfold in our backyards. . . .
- 4 So we’ve learned, scientists and laypeople alike, that native species are good and non-natives are bad.
- 5 Julian Olden, a biologist at the University of Washington, Seattle, who co-organized the symposium, recently polled nearly 2,000 ecologists. Among his findings: a substantial number of them said they would immediately eradicate a hypothetical non-native forest plant, even if it were shown to have no effect on the forest. Olden calls this the “guilty even when proven innocent” approach.
- 6 That kind of approach is not very useful on a rapidly changing planet.

Exotics Are Everywhere

- 7 Climate change is making it harder even to decide who the invaders are.
- 8 How, scientists at the symposium wondered, do you define “native” on a warming planet, when plants and animals are already moving toward the poles or up mountainsides in search of climate conditions they can tolerate? Should we consider them “invasive” in their new homes? Regardless of what we label them, conservationists will be reluctant to remove them from their new environs—to do so would stymie¹ their chances of adapting to the warmer future we’re creating.
- 9 And then there are the non-natives that we actually like. Most domestic crops are exotic in most of the places they’re grown, but there are even wild exotics that “do good,” forming useful relationships with native species.

¹**stymie:** hinder or interfere with

- 10 Edwin Grosholz of the University of California, Davis, told the recent symposium about one such relationship. On beaches in his state, non-native spartina grass has become important habitat for the endangered California clapper rail, a plump shorebird with a downward curving bill more at home on land than in the air. A project to rip out and poison the spartina—which grows in dense swaths that exclude many other shorebirds—saw clapper rail numbers go tumbling downward.
- 11 There are other examples like that. The endangered southwestern willow flycatcher nests in “invasive” tamarisk shrubs. Many native (and beautiful) Hawaiian flowers are now pollinated by the Japanese white-eye bird—because the native pollinators have been driven extinct by other non-native species.
- 12 Should we impose further risk on already endangered natives by severing these relationships? Or should we admire the resilience of nature and let such “well-behaved” exotics stay? . . .
- 13 Leave them alone, more and more conservationists are arguing, and stop focusing obsessively on categorizing species as native or non-native. Mark Davis, an ecologist at Macalester College in St. Paul, Minnesota, once considered himself an “invasion biologist”—but not anymore. “I am actively trying to get the field to retire the invader narrative,” he said in Missoula.

A Good Thing, Not the Only Thing

- 14 After all, nativeness is just one environmental value, and arguably not as important as preventing extinctions and preserving biodiversity. In some cases we can best serve biodiversity by leaving the non-natives alone or even—brace yourself, now—introducing them on purpose.
- 15 This is the thinking behind, for example, installing the Aldabra tortoise on the islands of Mauritius. The islands lost their own large tortoises, and the fruiting plants that formerly had their seeds moved around by these fruit-loving reptiles have been on the decline. A tortoise that’s related to the island’s large tortoises—a non-native from the Seychelles in the Indian Ocean that was intentionally introduced in 2004—is now handling some of that work.
- 16 Most of the time, for the time being, conserving species still means focusing on supporting them in their historical habitats, planting natives and removing non-natives. We can and should do that in places where it is feasible and important to us.

From “It’s Time to Stop Thinking That All Non-Native Species Are Evil” by Emma Marris from NATIONAL GEOGRAPHIC MAGAZINE, July 24, 2014. Copyright © 2014 by National Geographic Society.

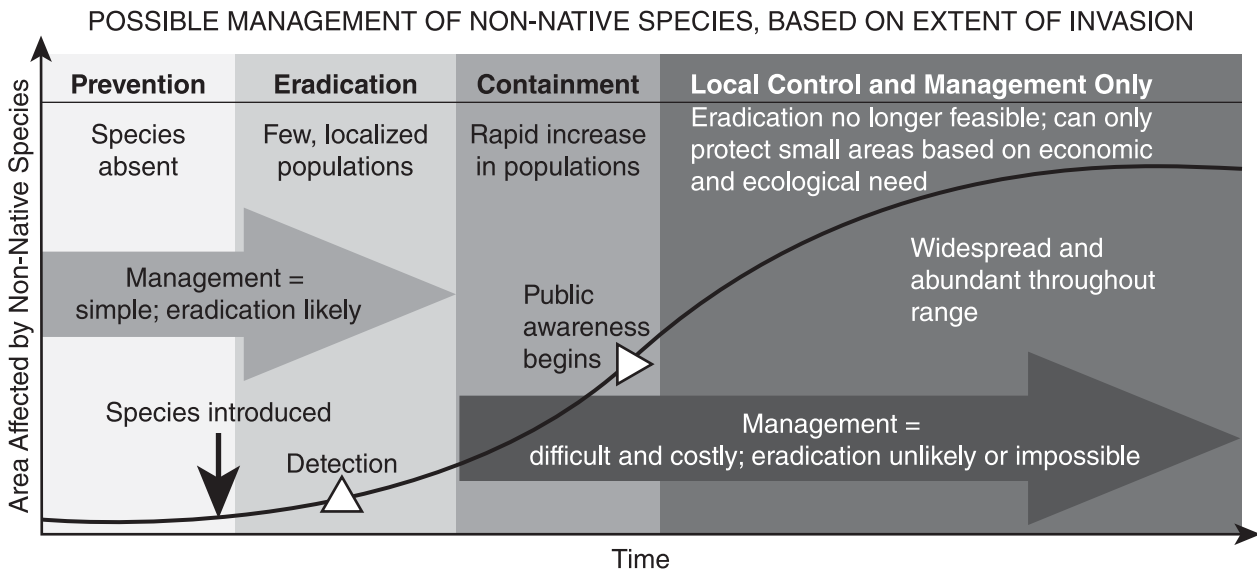

- 51.** Which sentence from the excerpt supports the conclusion that Elton’s “militaristic ‘invasion’ metaphor” (paragraph 1) has influenced scientific understanding of non-native species?
- A.** “Among [Olden’s] findings: a substantial number of them said they would immediately eradicate a hypothetical non-native forest plant, even if it were shown to have no effect on the forest.” (paragraph 5)
 - B.** “Regardless of what we label them, conservationists will be reluctant to remove them from their new environs—to do so would stymie their chances of adapting to the warmer future we’re creating.” (paragraph 8)
 - C.** “A project to rip out and poison the spartina—which grows in dense swaths that exclude many other shorebirds—saw clapper rail numbers go tumbling downward.” (paragraph 10)
 - D.** “In some cases we can best serve biodiversity by leaving the non-natives alone or even—brace yourself, now—introducing them on purpose.” (paragraph 14)
- 52.** Climate change has affected efforts to manage invasive species mainly by causing ecologists to
- E.** call upon the public to be more tolerant of the presence of non-native species.
 - F.** admit that past attempts to eliminate non-native species have damaged the environment.
 - G.** find ways of ensuring that native species are not harmed by the arrival of new species.
 - H.** acknowledge that it is not realistic for some species to remain in their native habitats.

- 53.** Which detail provides the **most** relevant support for the claim that “climate change is making it harder even to decide who the invaders are” (paragraph 7)?
- A.** the mention in paragraph 8 of non-native species that are forced to seek new habitats
 - B.** the acknowledgment in paragraph 9 that non-native species include many domestic crops
 - C.** the description in paragraph 11 of the interactions between native and non-native species
 - D.** the account in paragraph 13 of an ecologist who changed his beliefs about non-native species
- 54.** The author’s use of cause and effect in paragraphs 10–11 mainly emphasizes the idea that
- E.** some non-native species have helped their environments while others have had harmful impacts.
 - F.** attempts to remove non-native species have seldom produced desired results.
 - G.** some endangered native species have flourished because of the presence of non-native species.
 - H.** interactions between endangered native species and non-native species must be carefully monitored.
- 55.** Which sentence from the excerpt supports the idea that some species are able to adjust to change?
- A.** “Native gardens have become increasingly popular, both as ways to celebrate the unique flora of each region and as tiny hot spots of diversity.” (paragraph 3)
 - B.** “Many native (and beautiful) Hawaiian flowers are now pollinated by the Japanese white-eye bird—because the native pollinators have been driven extinct by other non-native species.” (paragraph 11)
 - C.** “After all, nativeness is just one environmental value, and arguably not as important as preventing extinctions and preserving biodiversity.” (paragraph 14)
 - D.** “The islands lost their own large tortoises, and the fruiting plants that formerly had their seeds moved around by these fruit-loving reptiles have been on the decline.” (paragraph 15)

- 56.** The details in the section “A Good Thing, Not the Only Thing” convey a central idea of the excerpt by suggesting that
- E.** some non-native species can replace native species that are unable to survive on their own.
 - F.** decisions about whether to keep non-native species should be considered on an individual basis.
 - G.** the scientists who study rapidly changing ecosystems agree that non-native species enhance biodiversity.
 - H.** a natural habitat that is healthy should be able to support a blend of native and non-native species.
- 57.** How does the chart provide additional support for a central idea of the excerpt?
- A.** by implying that the public becomes aware of non-native species only after removal is impossible
 - B.** by showing that the complete removal of non-native species is usually not achievable after a certain period of time
 - C.** by demonstrating why non-native species can be destructive if they are not removed from an area immediately
 - D.** by explaining how some conservation groups have approached the removal of non-native species

CONTINUE TO THE NEXT PAGE ►

PART 2 — MATHEMATICS

57 QUESTIONS

IMPORTANT NOTES

- (1) Formulas and definitions of mathematical terms and symbols are **not** provided.
- (2) Diagrams other than graphs are **not** necessarily drawn to scale. Do not assume any relationship in a diagram unless it is specifically stated or can be determined from the information given.
- (3) Assume that a diagram is in one plane unless the question specifically states that it is not.
- (4) Graphs are drawn to scale. Unless stated otherwise, you can assume relationships according to appearance. For example, lines on a graph that appear to be parallel can be assumed to be parallel. This is also true for concurrent lines, straight lines, collinear points, right angles, etc.
- (5) Reduce (simplify) all fractions to lowest terms.

GRID-IN QUESTION NOTES

- (1) For each grid-in question, write your answer at the top of the grid.
- (2) Begin recording your answer in the columns on the far left.
- (3) Fill in the circle under the box that matches the number or symbol you wrote. Leave the negative sign bubble blank if your answer is positive.

(Answer: -1.5)

	-	1	.	5		
Negative sign →	<input checked="" type="radio"/>	<input type="radio"/>	<input checked="" type="radio"/>	<input type="radio"/>	<input type="radio"/>	← Decimal point
	0	0	0	0		
	1	1	1	1		
	2	2	2	2		
	3	3	3	3		
	4	4	4	4		
	5	5	<input checked="" type="radio"/>	5		
	6	6	6	6		
	7	7	7	7		
	8	8	8	8		
	9	9	9	9		

(Answer: 3.2)

		3	.	2		
Negative sign →	<input type="radio"/>	<input type="radio"/>	<input checked="" type="radio"/>	<input type="radio"/>	<input type="radio"/>	← Decimal point
	0	0	0	0		
	1	1	1	1		
	2	2	2	<input checked="" type="radio"/>		
	3	3	3	3		
	4	4	4	4		
	5	5	5	5		
	6	6	6	6		
	7	7	7	7		
	8	8	8	8		
	9	9	9	9		

CONTINUE TO THE NEXT PAGE ►

GRID-IN QUESTIONS

QUESTIONS 58–62

DIRECTIONS: Solve each problem. On the answer sheet, write your answer in the boxes at the top of the grid. Start on the left side of each grid. Print only one number or symbol in each box. Under each box, fill in the circle that matches the number or symbol you wrote above.

- Do not fill in a circle under an unused box.
- Do not leave a box blank in the middle of an answer.

58. The figure below shows a circle with a hole in the middle. The outer diameter of the circle is $1\frac{1}{4}$ inches. The diameter of the hole is $\frac{1}{4}$ inch.

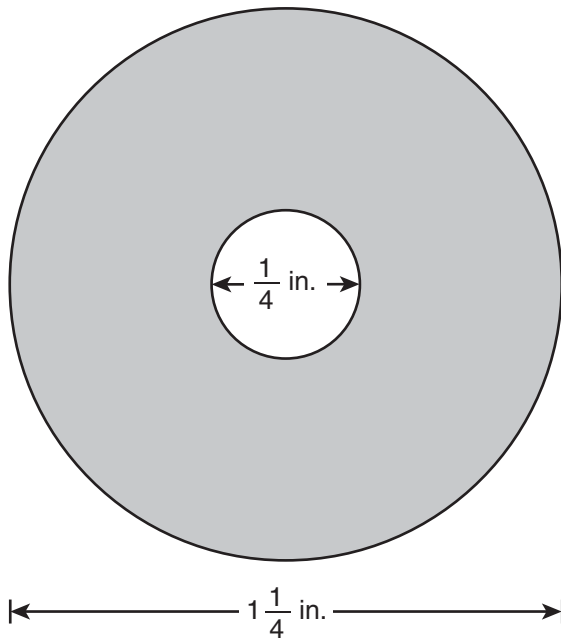

What is the area of the shaded region, to the nearest hundredth of a square inch?

59. A homeowner has a budget of \$135 for the installation of a light fixture. An electrician charges \$60 per hour plus a one-time trip charge of \$45. What is the **greatest** amount of time, in hours, the electrician can work on the installation while staying within the homeowner's budget? Write your answer as a decimal.

60. The list shows the daily low temperatures in a city during six days in the winter.

7°F , 4°F , 1°F , -2°F , -5°F , 3°F

What is the difference between the lowest and highest temperatures, in degrees Fahrenheit, for the six days?

61. A grocery store sells 1-gallon containers of milk for \$3.99. The store also sells orange juice in a 6-pack of 5.5-fluid-ounce bottles for \$1.79. Suppose the store wants to sell its orange juice in gallon containers instead. To the nearest dollar, how much more would a gallon of orange juice cost than a gallon of milk?

62.

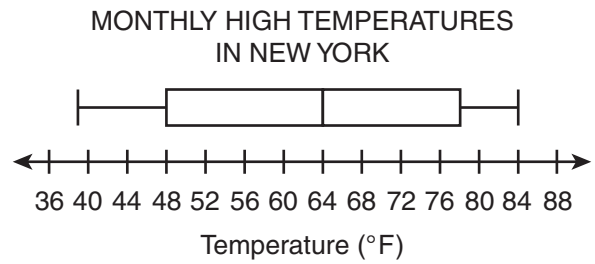

The box plot shows the average monthly high temperatures in New York City for 12 months. What is the difference between the range and the interquartile range of the temperature data?

MULTIPLE CHOICE QUESTIONS

QUESTIONS 63–114

DIRECTIONS: Solve each problem. Select the answer from the choices given. Mark the letter of your answer on the answer sheet. When you are solving problems, you can write in the test booklet or on the scrap paper given to you.

63. What is the prime factorization of 756?

- A. $2^2 \cdot 3^2 \cdot 21$
- B. $2^2 \cdot 3 \cdot 7 \cdot 9$
- C. $2^2 \cdot 7 \cdot 27$
- D. $2^2 \cdot 3^3 \cdot 7$

64.

$$\frac{x^2y^6}{xy^2}$$

What is the value of the expression above if $x = -2$ and $y = 2$?

- E. -64
- F. -32
- G. 16
- H. 32

65. If $(8 \div m) + 4 = 20$, what is the value of m ?

- A. $\frac{1}{3}$
- B. $\frac{1}{2}$
- C. 2
- D. 3

66. $6x = x - 1,680$

What is the value of x in the equation shown above?

- E. 336
- F. 240
- G. -240
- H. -336

67. A person buys a used car with a down payment of \$1,200 and makes monthly payments of \$275 for 3 years. What is the total amount the person pays for the car?
- A. \$2,025
B. \$9,900
C. \$11,100
D. \$13,500

68.

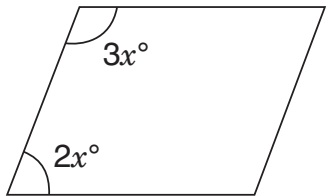

In the parallelogram above, what is the value of x ?

- E. 36
F. 18
G. 6
H. 5

69. A bus begins its trip with R occupants (including the driver). At each of the 20 stops, 3 people get on and no one leaves. If there are 3 times as many bus occupants at the end of the 20th stop as there are at the end of the 4th stop, how many occupants did the bus have immediately after the 10th stop?
- A. 12
B. 24
C. 30
D. 42

70. Jay sold n tickets. Pilar sold three times as many tickets as Jay did. Together, Jay and Pilar sold ten more tickets than Amie sold. Which expression shows how many tickets Amie sold?
- E. $10 - 4n$
F. $3n^2 + 10$
G. $4n + 10$
H. $4n - 10$

71.

$$-12 > 6x$$

For what values of x is the above inequality true?

- A. $x > -6$
- B. $x < -6$
- C. $x < -2$
- D. $x > -2$

72. If $5(x - 6y) = 50y$, what is the value of x in terms of y ?

- E. $16y$
- F. $15y$
- G. $11\frac{2}{5}y$
- H. $11y$

73.

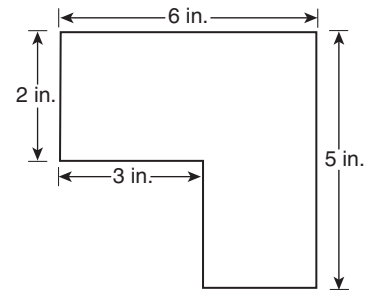

Scale: $\frac{1}{2}$ in. = 25 ft

A scale drawing of a new pool is shown above. All the corners are right angles. What is the perimeter of the actual pool?

- A. 550 ft
- B. 800 ft
- C. 1,100 ft
- D. 1,500 ft

74. Maria rides her bicycle to school at a constant speed of 15 miles per hour. If the distance to school is 6 miles, how many **minutes** will it take Maria to get to school?

- E. 10
- F. 15
- G. 24
- H. 30

75.

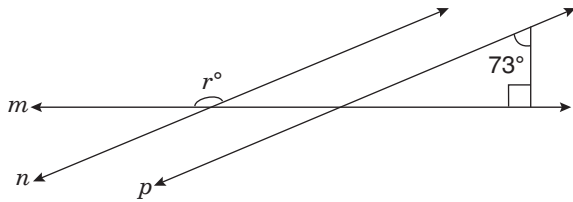

In the figure above, $n \parallel p$. Straight line m intersects both line n and line p . What is the value of r ?

- A. 17
- B. 117
- C. 163
- D. 173

76.

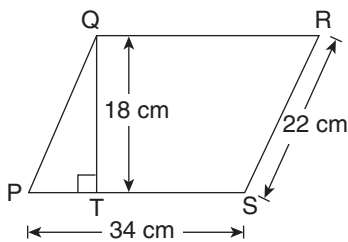

On parallelogram PQRS above, the length of \overline{QT} is 18 centimeters. What is the area of the parallelogram?

- E. 112 sq cm
- F. 396 sq cm
- G. 612 sq cm
- H. 748 sq cm

77. Allison has 5 stamp albums with 576 stamps in each album. If she transfers her stamp collection to 6 albums, each holding 378 stamps, how many stamps will be left over?

- A. 198
- B. 612
- C. 620
- D. 632

78. Start with the number 135.28 and perform the following steps in order:

- Step 1: Multiply by 10.
- Step 2: Add 0.5 to the result of Step 1.
- Step 3: Drop the digits after the decimal point.
- Step 4: Divide by 10.

What is the result?

- E. 13.5
- F. 135
- G. 135.2
- H. 135.3

79. If $x = -2$, what is the value of $|x + x^2 + x^3| - |x + 2x + 3x|$?

- A. -18
- B. -6
- C. -2
- D. 2

80. $\frac{3 + (-3)}{3 - (-3)} =$

- E. -1
- F. 0
- G. $\frac{1}{6}$
- H. 1

81. $12.96 \div 0.08 =$

- A. 1.62
- B. 16.2
- C. 162
- D. 1,620

82.

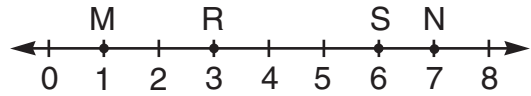

What is the distance between the midpoints of \overline{MN} and \overline{RS} ?

- E. $\frac{1}{2}$ unit
- F. 1 unit
- G. $1\frac{1}{2}$ units
- H. 2 units

83.

- I. $s - t$
- II. st^2
- III. s^t

If s is a positive integer and t is a negative integer, which of the above expressions **must** be a positive number?

- A. II only
- B. I and II only
- C. II and III only
- D. I, II, and III

84. What is the value of $\left(-\frac{3}{4}\right)\left(-\frac{2}{5}\right)$?

E. $-\frac{7}{20}$

F. $-\frac{3}{10}$

G. $\frac{3}{10}$

H. $\frac{7}{20}$

85. The table shows the income and expenses in a bicycle shop on one day.

BICYCLE SHOP TRANSACTIONS

Description	Income	Expense
Paid employees		\$120 × 4
Sold 2 bicycles	\$400 × 2	
Sold clothing	\$95	
Bought new door		\$500
Sold bike parts	p	

The sum of all transactions was \$70. What is the value of p ?

A. $-\$275$

B. $-\$85$

C. \$70

D. \$155

86. Dakota has four yardsticks and two 12-inch rulers. If she lays all four of the yardsticks and both rulers end-to-end, what is the maximum number of feet she can measure accurately at once?

E. 12 ft

F. 14 ft

G. 16 ft

H. 18 ft

87. In a fruit basket, the ratio of apples to oranges is the same as the ratio of cherries to walnuts. If there are 6 oranges, 16 cherries, and 48 walnuts, how many apples are there?

- A. 2
- B. 3
- C. 18
- D. 38

88. In a showing of an artist's works, the ratio of the number of paintings, drawings, and photographs shown is 3:5:4, respectively. If the number of drawings shown was 45, what is the total number of photographs and paintings that were shown?

- E. 36
- F. 63
- G. 84
- H. 108

89. For each $\frac{3}{8}$ foot of curtain width, $\frac{5}{6}$ yard of fabric is needed to make ruffles. How many yards of fabric are needed per foot of curtain width?

- A. $\frac{5}{16}$ yd
- B. $\frac{29}{24}$ yd
- C. $\frac{20}{9}$ yd
- D. $\frac{7}{2}$ yd

90.

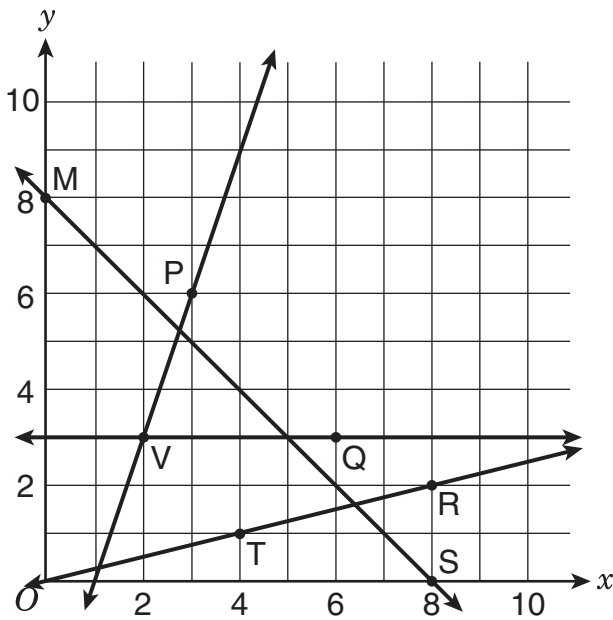

Which straight line is the graph of a proportional relationship?

- E. \overleftrightarrow{MS}
- F. \overleftrightarrow{VP}
- G. \overleftrightarrow{VQ}
- H. \overleftrightarrow{TR}

91.

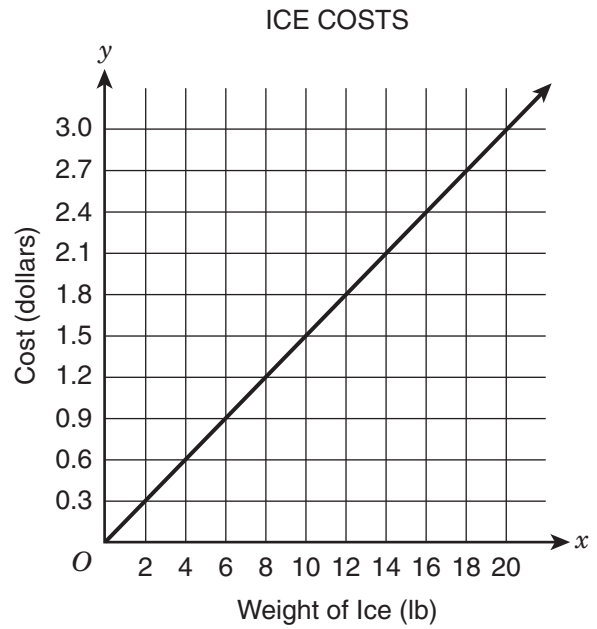

Some friends are buying bags of ice for a picnic. The graph shows the cost of the ice, in dollars, in relation to the weight, in pounds. Which statement about a point on the graph is true?

- A. The point (20, 3) means that 3 lb of ice costs \$20.00.
- B. The point (1, 0.15) means that 1 bag of ice costs \$0.15.
- C. The point (10, 1.5) means that 10 lb of ice costs \$1.50.
- D. The point (0, 0) means that 0 lb of ice will be needed if 0 people go to the picnic.

92.

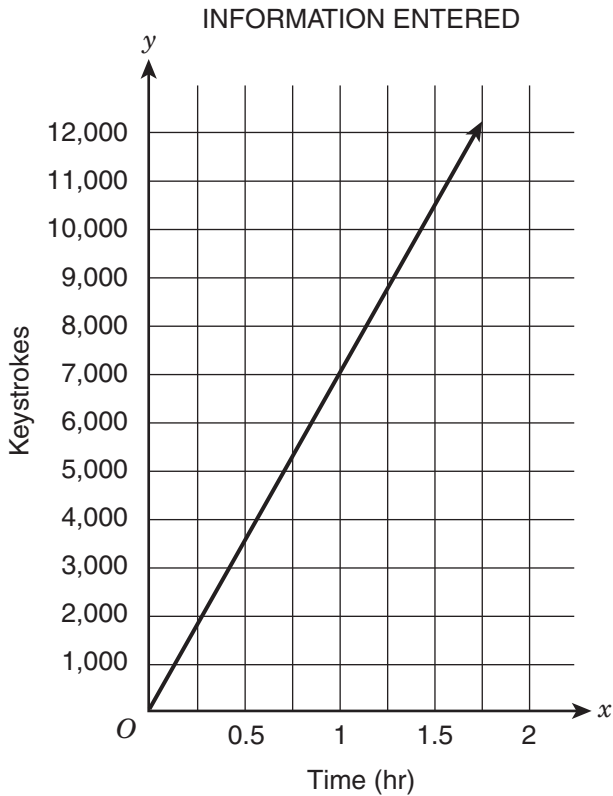

A clerk enters information on a computer. The graph shows the relationship between time, in hours, and the number of keystrokes the clerk makes. What is the meaning of the point (1.5, 10500) on the graph?

- E. The clerk makes 10,500 keystrokes in each 1 hr of entering information.
- F. The clerk makes 10,500 keystrokes in each 1.5 hr of entering information.
- G. The clerk makes 15,750 keystrokes in each 1 hr of entering information.
- H. The clerk makes 15,750 keystrokes in each 1.5 hr of entering information.

93. When the three-digit whole number $27\underline{\quad}$ is divided by 3 or by 4, the remainder is zero. What is the missing digit?

- A. 0
- B. 2
- C. 3
- D. 6

94.

FOOD CONSUMPTION OF THE AVERAGE AMERICAN PER YEAR

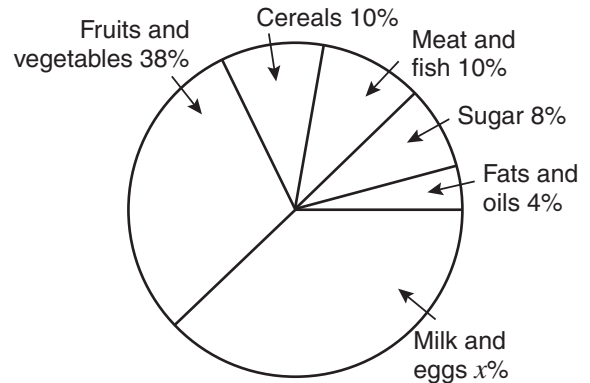

Total consumption = 1,840 pounds per person

Based on the circle graph, how many pounds of milk and eggs does the average American consume each year?

- E. 300
- F. 368
- G. 460
- H. 552

95. Out of 2,000 high school seniors, 191 were enrolled in the Honor Society. What percentage of the entire group of 2,000 seniors were in the Honor Society?

- A. 0.955%
- B. 1.91%
- C. 9.55%
- D. 19.1%

96.

NUMBER OF VISITORS TO BROOKSIDE ZOO

	Male	Female
Children	360	340
Adults	210	290

The table above shows the number of people who visited Brookside Zoo in one day. The largest of the four groups made up what percentage of all visitors on that day?

- E. 30%
- F. 28%
- G. 24%
- H. 17%

97. A bag contains 40 tiles that are either red, green, or blue. A tile is selected at random, the color is recorded, and the tile is put back in the bag. This process is carried out 120 times, and 18 of those times a red tile is selected. Based on the information, what is the most likely number of red tiles in the bag?

- A. 6
- B. 15
- C. 18
- D. 30

98.

LAST YEAR'S TOTAL ATTENDANCE

Attendees	Number
Children	1,750
Adults	2,250
Seniors	1,000
Total	5,000

If 100 individuals will attend the museum next week, what is the best estimate (based on last year's attendance) of the number of children who will be in that group?

- E. 30
- F. 34
- G. 35
- H. 50

99. A teacher will randomly select 3 students to be on a school committee. He will choose either a student from Classroom A or a student from Classroom B with each selection. This tree diagram shows the selection possibilities.

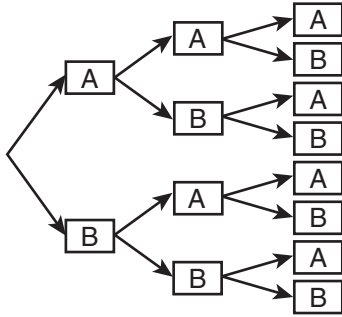

What is the probability that the teacher will select 2 students from Classroom A and 1 student from Classroom B (in any order) for the committee?

- A. $\frac{1}{8}$
 B. $\frac{3}{8}$
 C. $\frac{1}{2}$
 D. $\frac{3}{4}$

100. A bag contains 15 marbles: 11 blue marbles and 4 red marbles. Sarah picks one marble randomly, returns it to the bag, and then randomly picks one marble again. What is the probability that she picks a red marble **both** times?

- E. $\frac{16}{225}$
 F. $\frac{16}{121}$
 G. $\frac{8}{15}$
 H. $\frac{121}{225}$

101.

Report	Subject	Topic Choices
#1	Geography	Kenya, Thailand, Chile, Greece, New Zealand
#2	English	R. Frost, L. Hughes, N. Giovanni
#3	Science	1997 Mars mission
#4	Math	π , regular polyhedrons

Anita is assigned to report on 1 topic in each of the 4 subjects shown in the table above. How many different sets of 4 reports are possible, according to the choices available to her?

- A. 10
- B. 24
- C. 30
- D. 44

102. A deck of 52 playing cards contains 13 hearts. Sara has 12 cards from this deck in her hand, 3 of which are hearts. The other cards remain in the deck. What is the probability that a card drawn at random from the remainder of the deck will be a heart?

- E. $\frac{1}{10}$
- F. $\frac{1}{4}$
- G. $\frac{3}{13}$
- H. $\frac{1}{3}$

- 103.** The table shows the probability of randomly picking each flavor of candy from a bowl.

PICKING CANDY FROM
A BOWL

Flavor	Probability
Butterscotch	0.57
Lemon	0.095
Maple	0.125
Strawberry	0.21

Which flavor is most likely to be randomly picked?

- A.** butterscotch
- B.** lemon
- C.** maple
- D.** strawberry

- 104.** This formula can be used to determine p , the number of pages that will be in a book that contains w words, with an average of r words per page, and f extra pages in the front for the title and publishing information.

$$p = \frac{1}{r}w + f$$

If the formula is solved for w , it can be used to find the number of words in a book with p pages. What will the formula be if it is solved for w ?

E. $w = r(p - f)$

F. $w = \frac{1}{r}p + f$

G. $w = f + rp$

H. $w = r + p + f$

105. A shipment contains 170 small boxes of medical supplies. In a random sample of 20 of these boxes, 8 have damage and the others are undamaged. Based on this sample, what is the best prediction of the number of undamaged boxes in the shipment, **not** including the boxes in the random sample?

- A.** 60
- B.** 68
- C.** 90
- D.** 102

106. In basketball, a player can earn 1 point for making a free throw and 2 points for making another basket. Marcus makes a mean of 8 free throws per game, and he scores a total of at least 25 points per game. The inequality below shows this relationship, where b represents the number of 2-point baskets Marcus makes.

$$2b + 8 \geq 25$$

What is the number of 2-point baskets Marcus needs to make if he wants to score at least his minimum total points for a game and make his mean number of free throws?

- E.** $b \leq 8$
- F.** $b \geq 9$
- G.** $b \geq 16$
- H.** $b \leq 25$

107. Nadia paid \$1.00 to mail a letter. The cost to mail a letter is \$0.55 for the first ounce of weight plus \$0.15 for each additional ounce. What was the weight, in ounces, of the letter Nadia mailed?

- A.** 1.4
- B.** 1.5
- C.** 3
- D.** 4

108.

COST OF ORANGES

Number of Oranges	Cost
4	\$1.80
6	\$2.70
9	\$4.05

The table shows the cost of oranges. What is the unit rate for the cost per orange?

- E.** \$0.45
- F.** \$0.90
- G.** \$1.35
- H.** \$1.80

109. A softball player bought bottles of water for her team to have at practice. The total number of bottles she bought, b , is proportional to n , the number of players at practice. Which equation represents the relationship between b and n ? The constant of proportionality is p .

- A.** $b = pn$
- B.** $b = p + n$
- C.** $b + n = p$
- D.** $b + n + p = 1$

110. Malik earns \$10 per hour at his job. He wants to change to a job that will pay \$12 per hour. What will be the percent increase in Malik's hourly pay if he makes this job change?

- E.** 2%
- F.** 20%
- G.** 83%
- H.** 120%

111. A rain gauge shows that 10 centimeters of rain fell yesterday. If 1 inch is equal to approximately 2.5 centimeters, about how many inches of rain fell yesterday?

- A.** 1
- B.** 2.5
- C.** 4
- D.** 10

112. The height of a plant, in millimeters, is proportional to the number of days the plant has grown. The plant has grown 20 millimeters in 8 days. What is the constant of proportionality, in millimeters per day?

- E.** 0.4
- F.** 2.5
- G.** 12
- H.** 20

113. Which table shows a proportional relationship?

A.

x	y
0	0
4	$\frac{3}{2}$
8	3

B.

x	y
0	1
4	$\frac{7}{2}$
8	6

C.

x	y
0	-1
4	$-\frac{1}{2}$
8	0

D.

x	y
0	0
4	12
8	16

114. Terry wants to pour cement around the edge of the circular patio in her backyard. The patio has a radius of 5 feet. What is the distance, in feet, around the edge of the patio? Use 3.14 for π .

E. 15.7

F. 31.4

G. 49.3

H. 78.5

THIS IS THE END OF THE TEST.
IF TIME REMAINS, YOU SHOULD CHECK
YOUR ANSWERS. BE SURE THAT THERE
ARE NO STRAY MARKS, PARTIALLY
FILLED ANSWER CIRCLES, OR
INCOMPLETE ERASURES ON YOUR
ANSWER SHEET. ■

REVISING/EDITING PART A

1. The question asks for the revision that corrects the error in sentence structure in the paragraph.
 - A. **CORRECT.** The first sentence of the paragraph is a run-on because both clauses—“The land on Earth has not always been separated into the seven continents” and “at one time a massive supercontinent, known as Pangaea, covered one-third of Earth’s surface”—are independent clauses. Independent clauses are complete sentences, and two complete sentences should not be combined with just a comma. The revision is correct because it separates the two sentences by placing a period where it is needed after “continents” and by capitalizing the word “At.”
 - B. Incorrect. While adding a semicolon after “surface” can be considered a correct way to separate the independent clauses “at one time a massive supercontinent, known as Pangaea, covered one-third of Earth’s surface” and “Additionally, the supercontinent was surrounded by ocean waters called Panthalassa, much of which were in Earth’s Southern Hemisphere,” this change does not address the sentence structure error in the paragraph (the run-on sentence). The use of a period separating the independent clauses (complete sentences) is correct as is.
 - C. Incorrect. Adding a period after “Panthalassa” would separate the dependent clause “much of which were in Earth’s Southern Hemisphere” from its subject: “ocean waters called Panthalassa.” The dependent clause cannot stand on its own, because it shares elements with the main clause. A dependent clause is not a complete sentence and must be joined with an independent clause. The clause beginning with “much of which” is an adjective for “ocean waters.” Changing the comma to a period creates a new error (a sentence fragment) and does not address the existing sentence structure error at the beginning of the paragraph (the run-on sentence).
 - D. Incorrect. Removing the period after “crust” would create a run-on sentence because the period is needed to separate two complete sentences—“Geologists believe that the supercontinent split apart over millions of years because of the movement of the tectonic plates that form Earth’s crust” and “In fact, experts predict that over the next 250 million years the movement of the plates will cause the seven continents to merge into a supercontinent again.” A comma after “crust” would combine these sentences into a run-on, creating a new error in the sentence without fixing the existing sentence structure error (the run-on sentence) at the beginning of the paragraph.

2. The question asks for the revision of the sentence that uses the **most** precise language.
- E. Incorrect. The word “extremely” does not specify the precise length of the trail (2,200 miles); “millions” is less precise than the specific number of people who hike the trail each year (two million); and the verb “do” imprecisely describes the purpose of visiting the trail (hiking).
 - F. Incorrect. While the revision specifies the precise length of the trail and the verb “hike” precisely describes the purpose of visiting the trail, “more than a million” is less precise than the specific number of people who hike the trail each year (two million).
 - G. **CORRECT.** The length of the trail (2,200 miles), the specific number of people who hike the trail each year (two million), and the action of the visitors (hiking) are clear and precise in this revision of the sentence.
 - H. Incorrect. The word “lengthy” is less precise than specifying the actual length of the trail (2,200 miles); “a couple million” is less precise than the specific number of people who hike the trail each year (two million); and the verb “do” imprecisely describes the purpose of visiting the trail (hiking).
-

3. The question asks for the **best** way to combine the sentences.
- A. Incorrect. Although the option combines the sentences in a way that accurately reflects the meaning of each individual sentence, the combined sentence is a string of clauses that do not effectively cohere. Because it is poorly structured, the combined sentence does not clarify the relationship of ideas as effectively as the correct response does. The sentence incorrectly uses “but tourists,” and “which cost” modifies “the space station” but does not modify the trip. Compared with the correct response, the combined sentence in this option is also imprecise and unnecessarily wordy.
 - B. **CORRECT.** The option uses a complex sentence to present ideas clearly and precisely, and it shows the relationship between the ideas in the original sentences. In the first part of the sentence, the conjunction “and” correctly joins the first and second sentences by indicating a relationship, rather than a contrast, between the two. In the second part of the sentence, the conjunction “but” adds additional emphasis to the fact that while tourists will be allowed to visit the space station, the cost of the trip will likely prohibit most people from visiting.
 - C. Incorrect. Although the option combines the sentences in a way that accurately reflects the meaning of each individual sentence, the combined sentence is a string of clauses that do not effectively cohere. Because it is so poorly structured, the combined sentence does not clarify the relationship of ideas as effectively as the correct response does. Compared with the correct response, the combined sentence in this option is also imprecise and unnecessarily wordy.
 - D. Incorrect. The combination of the sentences contains an illogical relationship between ideas with the statement that tourists will be allowed to pay for visits to the space station *because* the cost is \$52–\$58 million round trip. The connection between the idea that “tourists will soon be allowed to pay for visits” and the subsequent “therefore few people will be able to take advantage of the opportunity” is also illogical.

4. The question asks which edit should be made to correct the sentence.
- E. **CORRECT.** The sentence in the box needs a comma to separate the coordinate adjectives. Coordinate adjectives describe characteristics of the same noun or subject and are connected with a comma or “and.” This option is the only one that places a comma where it is needed, between the coordinate adjectives “agile” and “athletic.”
 - F. Incorrect. The option incorrectly adds a comma in the middle of the phrase “first and only,” which modifies, or gives additional information about, “professional basketball player.”
 - G. Incorrect. The option incorrectly adds a comma between two adjectives that are not coordinate adjectives. “Only” is part of the phrase “first and only” and is modifying “professional basketball player.”
 - H. Incorrect. The option is incorrect because a comma is not needed to set off the phrase “to score 100 points in a single game.”
-

5. The question asks for the revision that corrects the error in sentence structure in the paragraph.
- A. **CORRECT.** As written, the first sentence (“In 1967 Katherine Switzer . . . legendary race.”) is a run-on sentence because a comma is used to combine two independent clauses. Independent clauses are complete sentences with a subject and a verb. The clauses—“In 1967 Katherine Switzer signed up for the Boston Marathon using her first and middle initials instead of her full name” and “at that time, only men were permitted to officially register and receive a number for the legendary race”—should be separated with a period instead. This revision correctly places a period after the word “name” and capitalizes the word “At” to separate the two independent clauses into two sentences.
 - B. Incorrect. The revision introduces an error into the paragraph and does not revise the run-on in the first sentence. The clause “Once officials realized a woman was attempting to run in the race” is a dependent clause functioning as an adverb of the independent clause that follows it. Changing the comma after the word “race” to a period would incorrectly separate the adverbial dependent clause from the independent clause.
 - C. Incorrect. The revision introduces an error into the paragraph and does not revise the run-on in the first sentence. The sentence “Switzer prevailed and finished in just over four hours, paving the way for the official rule change that allowed for the inclusion of women” is a complex sentence, which combines an independent clause (“Switzer prevailed and finished in just over four hours”) and a dependent clause (“paving the way for the official rule change that allowed for the inclusion of women”). The clause “paving the way for the official rule change that allowed for the inclusion of women” is not a complete sentence and must stay connected to the first part of the sentence. Changing the comma after “hours” to a period would incorrectly separate the dependent clause from the independent clause.
 - D. Incorrect. The revision introduces an error into the paragraph and does not revise the run-on in the first sentence. Changing the comma after “261” to a period would incorrectly separate the modifying clause “the same number she had worn in that first run in 1967” from the words it describes (“number 261”). Additionally, the clause “the same number she had worn in that first run in 1967” is not a complete sentence.

REVISING/EDITING PART B

Cracking the Code

6. The question asks for the **best** way to combine sentences 3 through 5 to clarify the relationship between ideas.
- E. Incorrect. While this sentence shows a relationship between the ideas, it does not clarify the relationship accurately. Learning the language of code does not depend on people’s previous ability to construct programs that will perform detailed and complex tasks. The word "because" incorrectly indicates that people can already construct complex programs prior to learning the coding language that would allow them to do so.
 - F. **CORRECT.** This sentence accurately shows the relationship between the ideas of the sentences. Before people can construct programs that will perform detailed and complex tasks, they have to learn a coding language. Knowing that language will, in turn, allow them to build programs that can perform detailed and complex tasks.
 - G. Incorrect. This sentence does not accurately express the relationship between ideas because the sentence implies that some people who code do not have to learn the language to perform their job functions. The passage clearly states that “computer code is part of every electronic interaction” (sentence 1) and that “programmers use it to instruct computers to perform different tasks” (sentence 2).
 - H. Incorrect. The conditional (If . . . then) construction of the sentence in Option D does not convey the intended relationship of the ideas in the sentences. The “then” statement (“they can construct programs that will perform detailed as well as complex tasks”) does not follow the condition of the “if” statement (“people who code have to learn this language”).
-
7. The question asks for the sentence that should follow sentence 5 to **best** state the main claim in the passage.
- A. **CORRECT.** This sentence logically follows sentence 5 and introduces the main idea of the passage: that due to the high demand for coding skills across a wide range of industries and disciplines, learning basic coding skills can provide a range of opportunities for personal growth.
 - B. Incorrect. While this sentence incorporates a point made in the passage about how coding can benefit many occupational fields (sentence 10), this idea alone does not address the entire argument in the passage. This sentence does not capture the passage’s emphasis on the variety of ways people can learn how to code (sentence 14).
 - C. Incorrect. While this sentence incorporates ideas about opportunities to learn coding skills in school (fourth paragraph), the larger claim presented in the passage is not about opportunities schools should offer in order to help students learn to code. The passage primarily focuses on the opportunities offered to people who take on the challenge of learning to code.
 - D. Incorrect. Although the passage discusses the opportunities that are available to some students to learn coding skills in school (sentences 15–16), this point is a supporting detail of the passage, not the main claim of the passage.

8. The question asks for the **best** revision of sentence 10 to provide a transition to the argument in the third paragraph.
- E. Incorrect. Some readers may choose this option because the second paragraph does discuss the complexities of coding; however, it does not discuss the difficulties of learning coding. The third paragraph demonstrates some of the complex ways coding is used in specific fields but does not illustrate how difficult learning coding may be.
 - F. **CORRECT.** This sentence provides the best revision of the transition sentence. The second paragraph ends with “the possibilities for applying them are infinite” (sentence 9), which supports the idea that people in “many occupational fields” (sentence 10) can benefit from having coding skills. The third paragraph illustrates this idea by providing specific examples of occupations that benefit from coding (stock market traders and doctors).
 - G. Incorrect. While sentence 13 suggests that employers recognize the value of coding skills, sentences 11 and 12 give examples of different industries that employ people who know how to code. The transition sentence should introduce the idea that coding skills are valuable to potential employees.
 - H. Incorrect. Some readers may choose this option because the second paragraph provides a brief definition of coding—“A coding language uses letters, numbers, and symbols that are arranged in a way that makes sense to a computer” (sentence 6)—which shows how this element of programming works, but the second paragraph does not specifically discuss what makes the field of computer programming unique. The third paragraph discusses how coding can be used in a variety of occupational fields (sentence 10).
-
9. The question asks which sentence would **best** follow sentence 13 and support the ideas in the third paragraph.
- A. Incorrect. While this sentence provides an example of a high salary, which is mentioned in the paragraph (sentence 13), the reference to “Experienced programmers, software engineers, and system administrators at large companies” focuses on specific occupations that may use coding, as opposed to the range of diverse occupations discussed in the third paragraph.
 - B. Incorrect. While sentence 12 does mention coding skills in the medical field as an example, the information provided in this answer supports only that idea and not the other ideas expressed in the third paragraph.
 - C. Incorrect. This sentence generally discusses employers looking for two things: “experience in a specific industry” and “knowledge of basic coding.” The third paragraph, however, discusses the possibilities of using coding skills in a variety of occupations. The words “experience in a specific industry” do not connect to the idea the paragraph develops.
 - D. **CORRECT.** This sentence provides specific evidence of the job market favoring potential employees who have coding ability. It supports what is stated in sentence 13, that “jobs that require coding skills are typically higher paying.”

10. The question asks which concluding sentence would **best** follow sentence 20 and support the argument presented in the passage.
- E. Incorrect. While the passage does state that “jobs that require coding skills are typically higher paying” (sentence 13), it does not say or imply that coding skills are needed for most high-paying jobs.
 - F. **CORRECT.** The sentence successfully summarizes the main argument of the passage, which is that coding is involved in all electronic interaction (sentence 1) and is a useful skill to master, especially in many occupational fields (sentence 10).
 - G. Incorrect. In the fourth paragraph, the passage does promote students taking advantage of opportunities to learn coding; however, this information is a supporting detail and would not serve as a strong conclusion to the argument presented in the passage.
 - H. Incorrect. Some readers may choose this sentence because the fourth paragraph discusses how “some students may become interested in learning how to create programs, such as games and apps” (sentence 18), but this detail is only one part of the overall argument in the passage.
-

Martial Arts for the Mind and Body

11. The question asks for the **best** way to combine sentences 2 and 3.
- A. Incorrect. This way of combining sentences 2 and 3 places unnecessary emphasis on characterizing historians, and it does not clearly show the contrasting relationship between the idea from sentence 2 that historians do not know the exact origins of martial arts and the idea in sentence 3 that historians know that martial arts have a long history.
 - B. **CORRECT.** This option is correct because the word “while” at the beginning of the sentence best indicates the contrast between the ideas in sentences 2 and 3. Sentence 2 states that historians do not know the exact origins of martial arts (“unsure of exactly when and where”). Sentence 3 describes what historians do know about these origins (“practiced by several different societies for many centuries”). This combination indicates that historians have a general understanding about the origins of martial arts even though they cannot confirm the exact details.
 - C. Incorrect. Starting this sentence with the word “because” indicates a cause-and-effect relationship that does not exist between the ideas in the original sentences. The idea from sentence 3, that historians know that martial arts have been practiced for many years, did not cause the idea in sentence 2, that historians do not know exact details about the origins of martial arts.
 - D. Incorrect. The conjunction (connecting word) “and” does not clearly show how the ideas in sentences 2 and 3 are related. While “and” can be used to combine related sentences, it does not demonstrate the contrast between the idea in sentence 2, that historians do not know the exact origins of martial arts, and the idea in sentence 3, that historians know that martial arts have a long history.

12. The question asks where sentence 10 should be moved to improve the organization of the second paragraph.
- E. Incorrect. Starting this paragraph with sentence 10 would weaken the paragraph’s organization because it would place a supporting detail sentence (sentence 10) before the topic sentence (sentence 6). Sentence 6 belongs at the beginning of the paragraph because it introduces the topic—the qualities of discipline, focus, and respect. Sentence 10 supports the key idea of the paragraph, that these qualities can be developed through the study of martial arts. If sentence 10 preceded sentence 6, the transitional phrase “for example” would refer to an unspecified topic and idea.
 - F. Incorrect. Sentence 6 presents the idea that “discipline, focus, and respect are important qualities for everyone to have,” but the example in sentence 10 does not directly relate to this idea. Sentence 10 explains how martial arts develop these qualities, not why they are important qualities to have. Because sentence 10 is not directly related to the idea in sentence 6 (the qualities are important), it should not follow sentence 6.
 - G. Incorrect. Sentences 7 and 8 should not be separated, because the idea presented in sentence 8—that “the study of martial arts can provide an opportunity to develop these skills”—is directly related to the idea from sentence 7—that the skills of discipline, focus, and respect “are not innate; they must be learned and practiced.” Sentence 10 supports the idea from sentence 8 by describing an example from a typical martial arts class, so sentence 10 should not precede sentence 8.
 - H. **CORRECT.** This option is correct because sentence 10 logically follows and supports the idea in sentence 8 that “the study of martial arts can provide an opportunity to develop” the qualities of discipline, focus, and respect. Sentence 10 explains this idea with examples, describing three specific ways that students in a typical tae kwon do class develop discipline, focus, and respect—by “diligently practicing,” “listening carefully,” and “bowing to the instructor and following directions.”
-

13. The question asks for the revision of sentence 12 that **best** maintains the formal style established in the passage.
- A. Incorrect. The phrases “A lot,” “put up with,” “difficult things,” and “do well in school” are worded informally; therefore, this sentence does not consistently maintain the formal style established in the passage.
 - B. Incorrect. The phrases “deal with,” “tough situations,” “stay on top of,” and “do well in life” are worded informally; therefore, this sentence does not consistently maintain the formal style established in the passage.
 - C. **CORRECT.** This option is correct because it uses clear and scholarly wording throughout the whole sentence. The phrases “many teenagers,” “encounter challenges,” and “succeed both academically and personally” make the sentence’s style more consistently formal than the other options.
 - D. Incorrect. The phrases “A lot,” “face problems,” and “keep up with” are worded informally; therefore, this sentence does not consistently maintain the formal style established in the passage.

14. The question asks for the transitional phrase that should be added to the beginning of sentence 17.
- E. **CORRECT.** This option is correct because it best shows the chronological progression between the ideas in sentence 16—progressing through levels of achievement “requires students to take responsibility and be accountable for achieving set goals”—and the ideas in sentence 17—“students gain confidence and experience companionship with other students who are progressing through the ranks.” The transitional phrase “over time” shows the gradual nature of the relationship between the cause in sentence 16 and the effect in sentence 17.
 - F. Incorrect. Though the ideas in sentences 16 and 17 are related, “in fact” does not show the correct relationship between the ideas. The transitional phrase “in fact” emphasizes an idea by giving a detail or example of greater intensity, but the ideas in sentence 16—progressing through levels “requires students to take responsibility and be accountable for achieving set goals”—and the ideas in sentence 17—“students gain confidence and experience companionship with other students who are progressing through the ranks”—are related by cause and effect rather than by (degree of) intensity.
 - G. Incorrect. The transitional phrase “even so” is used to connect opposing ideas, but the ideas in sentence 16—progressing through levels “requires students to take responsibility and be accountable for achieving set goals”—does not contrast with the ideas in sentence 17—“students gain confidence and experience companionship with other students who are progressing through the ranks.”
 - H. Incorrect. Although the transitional phrase “for instance” connects an idea with a related example, it does not show the cause-and-effect relationship between the ideas in sentence 16—progressing through levels “requires students to take responsibility and be accountable for achieving set goals”—and the ideas in sentence 17—“students gain confidence and experience companionship with other students who are progressing through the ranks.”
-
15. The question asks for the sentence that would **best** follow and support sentence 18.
- A. Incorrect. Though the idea of advancing one’s career is certainly appealing for adults, this benefit is not directly tied to “health and fitness” and, therefore, does not support sentence 18.
 - B. Incorrect. While the passage does discuss potential benefits related to discipline, focus, and confidence (sentences 6 and 11), sentence 18 is solely related to health and fitness benefits and should not be followed by a description of “other skills.”
 - C. **CORRECT.** This option is correct because sentence 18 conveys that the greatest benefit of practicing martial arts is “health and fitness,” and the sentence illustrates some specific ways that martial arts training helps improve physical fitness—“strengthen their heart, boost endurance, improve balance, and develop muscle tone.”
 - D. Incorrect. Some readers may choose this option because sentence 5, sentence 15, and sentence 18 discuss the physical aspects of practicing martial arts, but the idea that people who practice martial arts are concerned about their overall health does not provide further details about the connection between training and health.

- 16.** The question asks for the concluding sentence that **best** replaces sentence 23 and supports the topic presented in the passage.
- E.** Incorrect. The phrase “the skills needed to progress in rank” is vague, and progressing in rank is not related to the overall topic of the passage, which is the benefits of studying martial arts. The topic of the passage is not the “many ways to begin studying martial arts” or how “people can easily discover” the benefits of martial arts.
 - F. CORRECT.** This option is correct because it best supports the topic of the passage—the benefits of studying martial arts—by stating two reasons why people should study martial arts: to “experience the satisfaction of achieving goals while also improving themselves.”
 - G.** Incorrect. Some readers may choose this option because it refers to the benefits of martial arts, but the word “because” and the detail that “enrollment in martial arts courses has increased” make this sentence unrelated to the overall topic of the passage, which is about the benefits of studying martial arts, not the number of people who participate.
 - H.** Incorrect. Although the benefits of studying martial arts are described for both teens (in the third paragraph) and adults (in the fourth paragraph), the topic of the passage is the overall benefits of studying martial arts, which include mental discipline (discussed in the first, second, and third paragraphs) in addition to health benefits. Furthermore, the passage does not compare the health effects of studying martial arts across age groups.

READING COMPREHENSION

Excerpt from "Scribe Like an Egyptian"

- 17.** The question asks for a sentence from the excerpt that supports the idea that different levels of education were available to scribes.
- A.** Incorrect. The sentence from paragraph 1 provides evidence that Egyptian scribes used two different forms of writing, but it does not address the topic of education or the different levels of education that were available to scribes.
 - B.** Incorrect. The advantages and purposes of hieratic script are described in this sentence from paragraph 2, but this explanation of the advantages and purposes does not suggest that there were different levels of education for scribes.
 - C.** Incorrect. The fact that scribes could learn their trade through apprenticeships as discussed in this sentence from paragraph 4 does provide evidence that another method of learning to be a scribe was possible, but this process was for a limited entry into becoming a scribe, not the continued education scribes would need in order to work in specific areas.
 - D. CORRECT.** By explaining that certain professions required additional years of training, this sentence from paragraph 6 supports the idea that different levels of education existed for scribes.
-
- 18.** The question asks for an explanation of the author's purpose for including a sentence in paragraph 2 that describes the two types of hieroglyphs and the main uses of this particular writing system.
- E.** Incorrect. The sentence explains that hieroglyphs were used for formal inscriptions, but it does not suggest that these inscriptions were limited to royal and religious contexts.
 - F.** Incorrect. The sentence describes the two basic types of hieroglyphs, ideograms and phonograms, but it does not address how experts interpret the ancient writing system. A sentence earlier in the paragraph explains that the hieroglyphs were deciphered by Champollion, but it does not explain how he deciphered them.
 - G.** Incorrect. Although the sentence explains that the hieroglyphs were typically used for formal inscriptions, it does not provide an explanation of the significance or importance of hieroglyphs in the Egyptian language.
 - H. CORRECT.** The sentence explains that hieroglyphs included both phonograms and ideograms that were used in formal inscriptions and funeral papyri; therefore, this sentence achieves the purpose of describing the basic features of hieroglyphs as conveying either words and ideas or sounds, in addition to explaining the common uses for the writing system.

19. The question asks for the **best** summary of the process that schools used to train scribes.
- A. Incorrect. This summary incorrectly explains that scribes were expected to learn 450 hieratic signs instead of 450 hieroglyphs along with their hieratic versions as explained in paragraph 6. In paragraph 5, the author explains that scribes copied texts as part of the process of learning the scripts rather than as practice after the signs had already been memorized.
 - B. **CORRECT.** Paragraph 5 explains that students began by learning hieratic script and studied for about five or six years by using “exemplar documents and extracts from popular texts to copy, to practice their hieratic handwriting.” The paragraph also explains that during this time, they learned only the basics of hieroglyphic script.
 - C. Incorrect. Although paragraph 5 does explain that the scribes spent five or six years learning hieratic script, it does not suggest that hieroglyphs were learned only during apprenticeships.
 - D. Incorrect. This summary correctly explains that scribes learned two types of scripts, but the second sentence of the summary is incorrect. In paragraph 5, the author explains that the students copied from exemplar texts, but the author clearly states that the purpose of this copy work was “to practice their hieratic handwriting” and does not suggest that the copy work was used to practice hieroglyphs. Paragraph 6 explains that scribes could make lists and write letters as part of their professional skills but does not suggest that copy work was used to help them learn these tasks.
-

20. The question asks for the claim that is **best** supported by the details in paragraphs 3 and 4.
- E. Incorrect. While paragraph 4 does explain that boys from poorer families had more challenges in receiving an education, the paragraph also provides examples of obtaining a patron or getting an apprenticeship as ways that these aspiring scribes could attain an education. Furthermore, the details in paragraph 3 do not provide any support for the claim that “common citizens” had difficulty getting an education because that paragraph focuses on the example of one person who was able to become a king as a result of his background as a scribe.
 - F. **CORRECT.** In paragraph 3, the author provides an example of a person who used his skills as a scribe to rise through the ranks of society by describing the achievements of Horemheb to support the idea that “no matter how humble his origins, an educated Egyptian could achieve almost anything.” The author continues in paragraph 4 to explain that with the proper support, some young Egyptians could become educated, thereby opening more opportunities for themselves.
 - G. Incorrect. Paragraph 4 explains that schools were supported by the government and religious institutions, but it also explains that apprenticeships were a method of learning the craft of the scribe. As the paragraph indicates, boys could also be helped in their education by support from “a wealthier relative or patron.”
 - H. Incorrect. In paragraph 4, the author details the kinds of sacrifices that were necessary for some poorer families to ensure education for their sons. However, as paragraph 3 reveals in its example of Horemheb, who was born of middle-ranking parents, the sacrifice of time and money was not required for all families.

- 21.** The question asks why hieratic script was especially valuable in a bureaucratic government.
- A. CORRECT.** Hieratic script is described in paragraph 1 as being simpler for the “multitude of everyday documents” generated by the government and as “quicker to write and more economical of space” in paragraph 2. The logical conclusion based on these details is that hieratic script was more efficient for the large amounts of documentation produced by the government.
 - B.** Incorrect. In paragraph 4, the author explains that “education was not available to all,” suggesting that only people who were educated could read and write. The excerpt as a whole does not provide sufficient information to indicate what portion of the general public would be able to comprehend material written in hieratic script.
 - C.** Incorrect. The idea that becoming a scribe could lead to taking different positions in society is addressed in paragraphs 3, 4, and 6. However, the use of hieratic script in the fields of medicine, law, or religion does not necessarily explain the value of the script for the bureaucratic government referenced in the question.
 - D.** Incorrect. Although different professions such as doctors and lawyers used hieratic script, the author uses these professions as examples of different job opportunities for scribes in paragraph 6. There is no discussion in the excerpt about different professions communicating with each other, and these professions were not necessarily part of the bureaucratic government.
-

- 22.** The question asks how the diagram of ancient Egyptian class structure supports the topic of the excerpt.
- E. CORRECT.** The focus of the excerpt is the opportunities available to scribes in different professions and how people became scribes and therefore improved their position. By illustrating the position of the scribes in the class structure of ancient Egypt, the diagram supports the idea that scribes were valuable members of society.
 - F.** Incorrect. The professions of the different social classes are shown in the diagram, but it does not address specific tasks. Furthermore, the main topic of the excerpt is the role of the scribes in society rather than the tasks performed by the different social classes.
 - G.** Incorrect. While the diagram does show the position of scribes in the social hierarchy, it does not provide an illustration of movement between the different classes or rankings, so the diagram does not support the idea that scribes were able to improve their social standing.
 - H.** Incorrect. The diagram shows the class structure as hierarchical and can support readers’ efforts to compare the different social positions. However, the role of scribes in society, rather than a general comparison of different classes, is the main focus of the excerpt.

23. The question asks for a statement with which the author would **most** strongly agree.
- A. Incorrect. The author only addresses boys who entered the profession of scribes. While the author does address the role of the family in supporting a boy’s education or securing an apprenticeship, the author does not provide any discussion to support the idea that boys were only encouraged to follow the professions of their male relatives.
 - B. Incorrect. The author explains that communication using hieroglyphs was not widely practiced in everyday correspondence and that hieratic script was the more popular form of writing. While being able to read and use hieroglyphs would have been helpful, it was not common for citizens to use this formal form of communication. In addition, scribes were trained to learn hieroglyphs and hieratic script as part of their education, so prior ability to read or compose hieroglyphs was not a requirement.
 - C. **CORRECT.** As described in paragraph 2, hieratic script was more efficient and economical than hieroglyphs. Because this script was used for “everyday purposes,” it was the more practical of the scripts as hieroglyphs were reserved for “formal inscriptions.”
 - D. Incorrect. In paragraph 6, the author indicates that “any half-competent scribe” could become employed in making and updating lists. While the paragraph later indicates that scribes would need to study several more years to be employed in a wider range of professions, there is no indication that employment as a scribe would be unavailable to a boy who studied for only a few years.
-

Excerpt from "Do Them No Harm!"

24. The question asks how paragraph 1 contributes to the setting of the excerpt.
- E. **CORRECT.** Paragraph 1 describes summer “when salmon spawn,” “huckleberries ripen,” and The People gather for “their annual camas harvest.” These descriptions show the abundance of food in the place where the excerpt occurs.
 - F. Incorrect. Although the setting refers to past events, the narration is not by The People. In addition, the voice narrating the excerpt is not an element of the setting.
 - G. Incorrect. Nothing in paragraph 1 suggests that the camp is changing in any way. The People gather annually in this place. In addition, the language used to describe the setting does not suggest any problems.
 - H. Incorrect. The People are not making observations about the setting in paragraph 1. They are described as performing actions, such as gathering “for the work and festivities of their annual . . . harvest.”

25. The question asks how the beginning of the change of seasons mainly affects the characters.
- A. **CORRECT.** Paragraph 4 describes the time as the last chance for The People to be together “before the Cold Moons kept them close to their fires.” Paragraph 6 tells about how the women were working hard to dig and cure roots, because “WARM was going and COLD was coming.” These paragraphs describe both celebration and preparation before the winter comes.
 - B. Incorrect. Paragraphs 4 and 6 describe the characters working hard, but there is no discussion of them wanting to rest and relax.
 - C. Incorrect. While both paragraphs describe some of the work involved in the harvest, paragraph 4 also lists a number of leisure activities, such as visiting, foot racing, horse racing, gambling, and stick games. The characters are still taking the time to relax.
 - D. Incorrect. While paragraph 4 mentions trading in a list of activities that the characters are doing, this is just one of many activities. Allowing the characters to trade goods is not the way the change in seasons mainly affects them.
-

26. The question asks how paragraphs 7 and 9 convey a central idea of the excerpt.
- E. Incorrect. Paragraphs 7 and 9 describe activities that The People do at the Red Bear camp. They do not describe The People exploring new areas.
 - F. Incorrect. While paragraph 7 lists some of the activities that The People did to help, neither paragraph emphasizes that The People need to be organized.
 - G. Incorrect. Paragraph 9 mentions how the sun blessed the Red Bear camp. However, these paragraphs do not otherwise mention weather.
 - H. **CORRECT.** Paragraph 7 lists activities that The People do with one another. Paragraph 9 states that “all were busy with their daily tasks.” Everyone is contributing to the community in their preparation for winter.
-

27. The question asks what is the **most likely** reason that the author repeats the word “played” in paragraph 8.
- A. Incorrect. Paragraph 7 describes the different tasks that the adults were doing at this time. They were not watching the children play, because they were busy working.
 - B. Incorrect. While everyone enjoys being at the gathering, the word “played” does not describe the activities of the adults. As described in paragraph 7, the adults are working together at various tasks.
 - C. Incorrect. The word “played” is used before phrases describing what the children did. It is not used to list activities available for all at the gathering.
 - D. **CORRECT.** The word “played” appears before different activities that the children did, such as pretending to hunt, take care of the babies, and take care of the animals. They played by pretending to do adult activities. The last sentence states that the children “learned how to live through their play.”

- 28.** The question asks how paragraphs 11–13 affect the plot of the excerpt.
- E.** Incorrect. The paragraphs contain questions about the arriving people. They do not present differing points of view.
 - F. CORRECT.** The paragraphs ask questions in which the characters wonder whether the arriving people are friends or enemies, or whether they might be bringing good news or bad news. By suggesting that the arriving people could present problems such as these, the paragraphs contribute to the rising action.
 - G.** Incorrect. The paragraphs do not lead to a turning point. Instead, they lead to the climax—the moment the characters discover who the visitors are. This means the paragraphs contribute to the rising action.
 - H.** Incorrect. Paragraphs 11–13 ask questions. They do not provide background information about the strangers; instead, they ask for it.
-

- 29.** The question asks how the phrases “trophies of their hunt” and “paraded around” affect paragraph 20.
- A.** Incorrect. The phrase “trophies of their hunt” describes the animals that the hunters have successfully found. They have already received their rewards (the animals) and are showing them to The People.
 - B.** Incorrect. The excerpt describes many ways that The People find and prepare their own food. While they appreciate the extra food, they are not dependent on the hunters.
 - C. CORRECT.** The hunters “parade around” because they are proud of the animals they have been able to get while hunting. Since a trophy is a recognition of success, they consider these animals their trophies.
 - D.** Incorrect. The phrases show the pride the hunters feel. As paragraph 20 says, the hunters want “all to see how strong their Hunting Power had been.” The phrases are focused on the hunters rather than on those who have gathered around them.

- 30.** The question asks which quotation from the excerpt **best** supports the idea that The People maintain a connection to members of their group in spite of distance.
- E.** Incorrect. This quotation describes the fact that The People always return to the same camp to perform the same traditional tasks and enjoy the same festivities as their ancestors. This quotation highlights the customs The People continue from their ancestors, but it does not focus on their present personal connections.
 - F. CORRECT.** This quotation alludes to The People’s eagerness to hear about the families who had traveled away from their group. This eagerness shows that they still feel a connection to these families, even though they are far apart.
 - G.** Incorrect. This quotation describes The People’s analysis of the visitors—that they may be hunters. It does not show a connection to the visitors.
 - H.** Incorrect. This quotation shows that The People are curious about a stranger who has come into their camp. It does not show closeness to distant members of the group.
-

Excerpt from "The Food Business Incubator"

- 31.** The question asks what the words “recognized” and “prestigious” convey about La Cocina.
- A.** Incorrect. While later information indicates that La Cocina bases its choices on the work ethic of entrepreneurs as well as their financial needs, the use of the words “recognized” and “prestigious” in the context of the sentence is not related to the work ethic of the chefs.
 - B. CORRECT.** The fact that alumni of the La Cocina program have received recognition as semi-finalists for prestigious awards shows that La Cocina has helped members of its program achieve at the highest level.
 - C.** Incorrect. As paragraph 1 indicates, La Cocina focuses on helping local food entrepreneurs develop their small businesses. While some participants in the program have earned official recognition, La Cocina is not primarily focused on establishing entrepreneurs as celebrated professionals.
 - D.** Incorrect. La Cocina assists chefs with the development of their small businesses, not necessarily with their development of specific products.

- 32.** The question asks how paragraph 4 contributes to the development of ideas about La Cocina in paragraph 1.
- E. CORRECT.** Paragraph 4 lists ways that La Cocina provides support to local food entrepreneurs. This supports the statement in paragraph 1 that La Cocina has been “helping local food entrepreneurs, many of whom are low-income immigrant women, develop their small businesses.”
 - F.** Incorrect. Paragraph 1 simply states that La Cocina tries to help local food entrepreneurs develop their businesses, but neither paragraph describes or mentions any goals that La Cocina sets for local food entrepreneurs.
 - G.** Incorrect. While paragraph 4 mentions some background information on where local food entrepreneurs were found, these details do not directly support any ideas in paragraph 1.
 - H.** Incorrect. The description of the process by which Caleb Zigas realized there was a need for La Cocina provides background for the organization, but it does not directly support any ideas in paragraph 1.
-

- 33.** The question asks how the description of Mariko Grady’s background in paragraph 9 contributes to a central idea in the excerpt.
- A.** Incorrect. The paragraph about Mariko Grady describes her earlier success in the field of theatrical dance and how she later started her own small cooking business. It does not describe what she was looking for when she came to La Cocina.
 - B.** Incorrect. The excerpt does not argue that La Cocina is the best option for people starting out in the food business, and the description in paragraph 9 does not support that idea.
 - C. CORRECT.** The detailed background story of Mariko Grady describes that Grady started a small food business after working as “a singer and dancer with the prestigious modern theatrical dance group she founded” and then, after that ended, created a fermented food product line. This information contributes to a central idea in the excerpt that many of the people working with La Cocina, like Grady, “needed an affordable commercial kitchen space and technical assistance in order for their businesses to be legally viable. La Cocina provided just such a space, in addition to helping them develop business plans, pull city permits and more” (paragraph 4).
 - D.** Incorrect. While Mariko Grady is now a food business owner that La Cocina has helped since 2012, Grady’s story does more to illustrate how people from non-business backgrounds can receive special support from La Cocina in order to do more with their business.

34. The question asks with which statement the author would **most likely** agree.
- E. Incorrect. The author does not suggest at any point that La Cocina would like to expand its work and mission to other cities.
 - F. Incorrect. While the author describes some of the work of talented chefs from La Cocina, at no point does the author imply that the many food choices that exist in San Francisco are because of La Cocina.
 - G. Incorrect. While the author does describe how La Cocina can help entrepreneurs find success, at no point does the author suggest that La Cocina can guarantee success.
 - H. **CORRECT.** The descriptions of the income requirements as well as the information that some of the chefs are James Beard award recipients and others have achieved success with their businesses all help show that the author admires the work of La Cocina in helping chefs who have few resources.
-
35. The question asks which detail would be **most** important to include in a summary of the excerpt.
- A. Incorrect. The detail about the cookbook that includes members' stories is mentioned briefly but not developed and should not be included in a summary.
 - B. **CORRECT.** The fact that La Cocina provides legal and technical assistance is a key factor in the success of the chefs who participate. Paragraph 4 explains that La Cocina provides technical and legal assistance by helping businesses navigate city permits and meet other challenges. This detail supports the central idea by sharing how La Cocina helps food entrepreneurs expand their businesses.
 - C. Incorrect. The specific requirements for chefs to be accepted at La Cocina are lesser details and should not be included in a summary.
 - D. Incorrect. Paragraph 5 indicates that vendors from La Cocina sell their food at various venues, including farmers' markets or corporate events. However, this is a detail that is not developed at any length and should not be included in a summary.

36. The question asks how the table provides additional support for a central idea of the excerpt.
- E. Incorrect. The table describes the requirements that allow food entrepreneurs to qualify to participate in La Cocina. While the table does mention that applicants without a business plan must contact one of La Cocina’s partner organizations, it does not specifically explain how La Cocina works with these partner organizations to help educate successful applicants.
 - F. Incorrect. The table describes the ways entrepreneur chefs must qualify in order to be accepted into La Cocina, not how their businesses can be successful after they leave.
 - G. Incorrect. While the table mentions community spirit, this is in reference to the type of energy La Cocina wishes to establish within its group kitchen space. The excerpt and table do not discuss providing food to different communities within or outside San Francisco as specific goals of La Cocina.
 - H. **CORRECT.** A central idea of the excerpt is that La Cocina helps local food entrepreneurs develop their businesses. The table lists requirements for people who want to participate in La Cocina. They must be willing to work hard to promote their own businesses as they use the resources that La Cocina provides.
-

Excerpt from "The Past and the Future of the Earth's Oldest Trees"

37. The question asks what the effect is of comparing groups of bristlecone pines to “a city within a cemetery” (paragraph 2).
- A. Incorrect. The reference to “a city within a cemetery” describes how new trees use the remnants of their “ancestors” (paragraph 2) and makes no comment on the appearance of young versus mature trees.
 - B. **CORRECT.** The “cemetery” contains “the bones of their ancestors” (paragraph 2)—“ancestors” being earlier generations of bristlecone pines—which provide some of the nutrients that the new trees need.
 - C. Incorrect. The reference to “a cemetery” is not a comment on how long bristlecone pines can live; rather, it illustrates that the new pines are using remnants of their “ancestors” (paragraph 2) to grow.
 - D. Incorrect. Although the climate is mentioned in paragraph 2, it is not the reason for the comparison to “a city within a cemetery.” The comment is intended to illustrate how the new trees use nutrients left behind by the old ones.

- 38.** The question asks how paragraph 4 conveys the idea that the bristlecone pine can withstand difficult conditions.
- E.** Incorrect. While paragraph 4 does mention the bristlecone pine in conjunction with other long-living trees, this does not explain in any way how the bristlecone pine can survive difficult conditions.
 - F. CORRECT.** Paragraph 4 mentions several qualities that help the bristlecone pine survive a difficult environment: it can survive in a “dry, cold climate” as few plants can, it tolerates a soil that is heavily alkaline and low in nutrients, and the density of its wood protects it from insects.
 - G.** Incorrect. Paragraph 4 focuses on the qualities of the bristlecone pine that make it well suited to the White Mountains rather than why the White Mountains are well suited to bristlecone pines.
 - H.** Incorrect. While paragraph 4 does acknowledge that the bristlecone pine has few competitors because the pine can stand conditions few other plants can stand, it is the examination of the pine’s unique qualities that explains how the pine survives those conditions.
-
- 39.** The question asks how the first sentence from paragraph 5 contributes to the development of ideas in the excerpt.
- A.** Incorrect. While “two-hundredths of an inch” is a reference to the bristlecone pine’s growth pattern, the point of the reference—and of the entire sentence—is to emphasize the incredibly slow pace of the pine’s life cycle.
 - B.** Incorrect. While “wars raged” is a threat that empires face, the point of mentioning wars and the rise and fall of empires is to emphasize the bristlecone pine’s slow-paced life cycle by contrasting its slowness with the big, dramatic changes taking place in human history at the same time.
 - C. CORRECT.** Making reference to huge changes in human history such as the rise and fall of empires and the raging of wars provides a sharp contrast to the incredibly slow growth of the bristlecone pine.
 - D.** Incorrect. This sentence describes how slowly the bristlecone pine grows in contrast to how dramatically human history changes in the same time span but never explains the reasons for the pine’s longevity.

- 40.** The question asks what the phrases “clings to life” and “stripped of bark” in paragraph 6 are used to emphasize.
- E.** Incorrect. While these two phrases are suggestive of the tree’s fragility, nothing in this paragraph suggests that the tree needs help to avoid extinction.
 - F.** Incorrect. While the tree may be misunderstood to be dead because it is “stripped of bark,” the phrase “clings to life” emphasizes the fact that the tree is not dead but manages to survive.
 - G.** Incorrect. The paragraph says that far from being interested in the tree’s unusual appearance, “most people march past it without giving it a second glance” (paragraph 6).
 - H. CORRECT.** The phrase “clings to life” emphasizes that the tree is still surviving even though it is partially fossilized, as shown by its “marbled hulk stripped of bark” (paragraph 6).
-
- 41.** The question asks which central idea of the excerpt is supported by the details in paragraph 7.
- A.** Incorrect. While paragraph 7 mentions the pines' ability to survive climate change, the central idea is about the trees' longevity. Surviving climate change is a part of the pines' longevity, but just surviving climate change does not fully encompass the central idea of the excerpt.
 - B.** Incorrect. Although the paragraph mentions that the “super-elderly trees” are each unique in appearance, their appearance does not directly connect to their ability to survive. The details in paragraph 7 emphasize the durability and longevity of the trees.
 - C.** Incorrect. While the beginning of paragraph 7 expresses the idea that each bristlecone pine appears to be a unique individual and supports the idea that humans relate to the pines, the paragraph expresses a stronger central idea in the last two sentences about the pines’ survival.
 - D. CORRECT.** The longevity of bristlecone pines is a central idea of the excerpt. Experts are encouraged that bristlecone pines have survived many catastrophes, and the details in the second half of paragraph 7 draw direct attention to the trees’ longevity.

- 42.** The question asks how the author conveys his point of view throughout the excerpt.
- E. CORRECT.** The author clearly conveys his interest in and admiration of the bristlecone pine by sharing many details throughout the excerpt that show how unusual the tree is; these include details about the tree using remnants from previous generations (paragraph 2), details about the “agonizingly” slow growth rate (paragraph 3), and details about the incredibly difficult growing conditions that the tree thrives in (paragraph 4).
 - F.** Incorrect. While the author does briefly compare the bristlecone pine to global empires (paragraphs 1, 3, and 5), he mainly offers many details throughout the excerpt about what makes the bristlecone pine so unusual.
 - G.** Incorrect. While paragraph 6 largely focuses on the contrast of the pine’s sickly appearance with its ability to survive, this is just one detail about the pine that makes it unusual. The author offers many such details throughout the excerpt.
 - H.** Incorrect. The author suggests in paragraph 7 that the bristlecone pine “may survive humanity,” but this is just one detail about the bristlecone that the author offers in an excerpt full of details, each of which contributes to an understanding of how unusual this tree is.
-
- 43.** The question asks for a summary of the bristlecone pine’s life cycle.
- A.** Incorrect. Though the summary in this option covers key points in the life cycle, it focuses on minor details (“stubby seedling” and “alkaline soil”) while leaving out major details in the life cycle (for example, the fact that parts of the trees become fossilized over time).
 - B.** Incorrect. The answer addresses the unique quality of the pine growing from “fragments of its dead ancestors”; however, it does not address the fossilization phase, which is a major part of the life cycle. In addition, this option incorrectly states that the tree continues to funnel nutrients to its stem.
 - C. CORRECT.** The option describes the key phases of the pine’s life cycle without focusing on minor details. The organization of the summary is chronological, and the information presented is accurate.
 - D.** Incorrect. The option focuses more on the location and the appearance of the pine than on the phases of the pine’s life cycle. The option contains an accurate description of the pine’s appearance but provides little information about the main phases of its life cycle.

"Bird Talk"

44. The question asks how lines 6–7 from the poem develop an idea from the second stanza.
- E. Incorrect. In lines 2–3, the tree branches exclaim that “ ‘This is the / beginning of summer,’ ” and the birds respond by taking “their hops and zigzags a little more / anxious” (lines 6–7); however, the birds’ eager reaction to the return of warmer weather is not referenced in the second stanza of the poem, which is more about the nature of birds generally than the changing of the seasons.
 - F. Incorrect. Birds are more likely to thrive in warmer weather as evidenced by some birds’ migration to a warmer climate during winter, and the creatures in the first stanza are responding to the “ ‘beginning of summer’ ” (line 3) in their own way, such as the birds who are taking “their hops and zigzags a little more / anxious” (lines 6–7). However, the thriving of birds during a particular season is not the focus of the second stanza; rather, it is focused on the general nature of birds.
 - G. **CORRECT.** The birds are taking “their hops and zigzags a little more / anxious” (lines 6–7) in light of warmer weather, but they are not making a big to-do of the change because “a home is a home; worms are worms” (line 7) any time of the year. Such a natural adjustment to seasonal changes is reflected in the second stanza, where the birds “count up this year as against next / year” (lines 26–27) because they are well accustomed to the cyclical nature of things.
 - H. Incorrect. Although the birds’ actions of “hops and zigzags” (line 6) may indicate some sort of preparation, these actions are not preparation but rather the internalized cognizance of the change that has occurred with little conscious thought. As revealed in the second stanza, birds do not ponder much about past or future but rather adapt naturally as things change.

45. This question asks for what a phrase reveals about the speaker's perspective on the change in seasons.
- A. **CORRECT.** The first stanza of the poem establishes the way different parts of the natural world, including both plants and animals, respond to the change in season. These lines reflect the way the wind in the leaves is the best indication of the seasonal change because it is the wind in the leaves that "talked most of all and said more than any others / though speaking the fewest words" (lines 13–14).
 - B. Incorrect. Although the sound of the wind is the most obvious sign of the seasonal change per the speaker, it is in response to the " 'beginning of summer' " (line 3) that the wind speaks through the leaves. The poem does not reveal that this figurative speech occurs throughout the seasons, only that it occurs during the transition to summer.
 - C. Incorrect. While the language used by the speaker indicates a deep appreciation for the natural phenomenon being witnessed, the language used does not indicate a feeling of being overwhelmed but rather a feeling of awareness.
 - D. Incorrect. Using the personification of the wind "speaking" (line 14) indicates an appreciation by the speaker for the power and volume of the wind's voice, but only one instance of the wind's speech, that which occurs at the " 'beginning of summer' " (line 3), is chronicled by the speaker in the poem.
-
46. The question asks how the repetition of a phrase contributes to the meaning of the poem in terms of conveying information about a cyclical event.
- E. **CORRECT.** This phrase is used twice verbatim, in both cases to show the figurative words spoken by the branches (lines 2–3) and the leaves on the branches (lines 18–19). Repetition of this phrase conveys the idea that the transition to summer occurs in the same manner each subsequent year and thus evokes the same response from nature.
 - F. Incorrect. While living things—branches and leaves—both make identical figurative utterances, they do so not because they have prepared for such an event. Rather, these living things take the change in stride because of the sameness and expectedness of the seasonal shifts, which occur in the same way each time.
 - G. Incorrect. Even though the branches and leaves have been imbued by the speaker with some degree of consciousness in their figurative ability to speak, they are not surprised by the change in seasons. They say the same thing each year because the same thing occurs each year in the same way.
 - H. Incorrect. Certain lines of the poem do describe the natural world during the change of seasons, such as lines 8–9: "The yellow spreads of the dandelions and buttercups / reached across the green pastures." However, this repeated phrase serves to evoke a sense of sameness and inevitability; it is not a phrase related to the physical appearance of the natural world, only the way the natural world responds to the seasonal change with simple acceptance for its sameness. The repeated lines do not hold any sort of expectation or anticipation for the coming of summer; they help relay observations made about the state of the season.

47. The question asks for the identification of a description that contrasts with the scarcity and bleakness of winter.
- A. Incorrect. These lines indicate that the frogs are first very excited about the shift from winter to spring, which causes them to make a loud “shrilling,” yet their sounds lessen after a time and grow weaker. As such, these lines contrast two periods of spring (early vs. later) and the response of the frogs to these two periods; the lines do not contrast the bleakness of winter with the abundance of spring or summer.
 - B. **CORRECT.** During winter, there is scarcity of plant life and a bleak landscape: trees lose their leaves, snow covers the ground, and nature appears dark and shuttered. In contrast, these lines reveal the bright “yellow spreads” of flowers and the verdant “green pastures” that are signs that winter has abated.
 - C. Incorrect. This description contrasts the sounds of “the breezes” of warmer air and the sounds made by grackles—a type of bird—rather than the bleakness and scarcity of winter and the abundance of the “ ‘beginning of summer’ ” (line 3).
 - D. Incorrect. These lines show the contrast between the two ways of looking at things in terms of past vs. present or present vs. future; in this instance, the lines reveal the way birds naturally expect and adapt to the passing of time and the change of seasons. The lines do not present a contrast between winter and spring.
-

48. This question asks how the description of the “bird talk” contributes to the central idea of the poem.
- E. Incorrect. The birds’ conversations may center around “who is here” and “who is not here and who used to be here” (lines 23–24), but the lines do not convey that the speaker feels a sense of loss, only that the birds have such figurative conversations in a direct way.
 - F. Incorrect. Though the birds are described in these lines by the speaker as “talking bird talk” (line 22), it is not suggested that this talk occurs more frequently in one season versus another, only that it occurs year after year because birds encounter seasonal changes as a constant.
 - G. **CORRECT.** In these lines, the birds gather, and some birds are not present but “used to be here” (line 24). These birds have likely succumbed to another of nature’s cycles: death, which affects all living things.
 - H. Incorrect. Though the description in these lines is a vivid one and includes anthropomorphism in the birds asking about “who is here” (line 23) and “counting up last year as against / this year” (lines 25–26), it gives no indication of the speaker’s level of enjoyment in observing nature.

49. This question asks for an explanation of how the poet conveys the speaker's point of view on the natural world and the change of seasons as presented in the poem.
- A. Incorrect. Though in the first stanza the speaker describes various elements of nature such as branches, frogs, birds, flowers, and leaves, these elemental shifts are not precisely gradual and occur only in the first stanza. Further, the first stanza, though appreciative of the natural world, is primarily descriptive and does not develop the speaker's perspective to the degree that other parts of the poem do.
 - B. Incorrect. While it may be inferred that the speaker describes the landscape to such a degree because it has revealed a seasonal shift, that this is indeed the speaker's motivation is never explicitly conveyed by the poet.
 - C. Incorrect. Multiple seasons do not pass in the poem; only the shift to the " 'beginning of summer' " (line 3) occurs in an endless cycle. Further, the speaker does not reveal an emotional response; it is the responses of nature that the speaker describes.
 - D. **CORRECT.** The first stanza is the speaker's observations of the natural world embracing a new season. In the second stanza, the speaker begins to reflect on how the natural world, as embodied by the birds, calmly accepts seasonal change in its perpetual sameness. The reflection continues in the third stanza, where it is revealed that the speaker has been addressing these observations to a child.
-

50. The question asks how the central idea about the natural acceptance of change by nature is developed by the speaker of the poem.
- E. Incorrect. The speaker is an observer of the changes in nature as propelled by the seasons and shows no personal eagerness for the end of winter. Further, even though nature rejoices at the end of winter as exemplified by "the shrilling of the frogs" (line 4), the speaker merely records this and does not share in this display.
 - F. **CORRECT.** The response of nature to the "beginning of summer" (line 3) is the primary focus of the poem as revealed by the speaker through vivid descriptions of the sights, sounds, movements, and attitudes of the natural world.
 - G. Incorrect. The second stanza of the poem begins a reflection on birds "sitting in circles talking bird talk" (line 22) and taking a sort of attendance of who is present, but this behavioral description is largely figurative and meant to illustrate a point about the way the birds adapt quickly to change, not to develop a central idea of the poem in terms of how nature responds generally.
 - H. Incorrect. Seasonal changes are inevitable and cyclical per the speaker, but the speaker does not predict future changes to the landscape as a method of developing the central idea. Rather, the speaker describes nature's response to changes that have already occurred.

Excerpt from "It's Time to Stop Thinking That All Non-Native Species Are Evil"

- 51.** The question asks which sentence from the excerpt supports the conclusion that Elton’s “militaristic ‘invasion’ metaphor” (paragraph 1) has influenced scientific understanding of non-native species.
- A. CORRECT.** This sentence shows that of the 2,000 ecologists Olden polled, many said they think it is right to “immediately eradicate” non-native species plants even if they are demonstrably harmless in their new environment. The response of these ecologists supports that Elton’s metaphor discussed in paragraph 1 has influenced scientific understanding.
 - B.** Incorrect. Rather than supporting the idea that the militaristic metaphor has influenced scientists, this sentence shows that conservationists, at any rate, are happy to let non-native species thrive wherever they can, given global warming.
 - C.** Incorrect. While this sentence does refer to efforts to eradicate a non-native species, the main point of it is that these efforts ended up harming a native species (the clapper rail shorebird).
 - D.** Incorrect. In contrast to supporting the idea that the militaristic invasion metaphor has influenced scientific understanding of non-native species, this sentence puts forth the bold idea of treating non-native species as something to be welcomed.
-
- 52.** This question asks how climate change has affected efforts to manage invasive species.
- E.** Incorrect. While ecologists are now arguing for some non-native species to be left alone (paragraph 13), they are arguing specifically on behalf of “well-behaved” non-native species (paragraph 12), not non-native species in general.
 - F.** Incorrect. While paragraph 10 describes how removing a non-native species negatively affected a native species, the excerpt never discusses the idea that attempts to eliminate non-native species might have damaged the environment.
 - G.** Incorrect. While the excerpt refers to climate change causing plants and animals to move to more tolerable environments (paragraph 8), it does not specifically discuss ways to ensure that the arrival of these non-native species does not harm native species.
 - H. CORRECT.** As paragraph 8 says, “plants and animals are already moving toward the poles” because of climate change, and ecologists recognize that those species need to do so to adapt “to the warmer future we’re creating.”

- 53.** The question asks which detail provides the **most** relevant support for the claim that “climate change is making it harder even to decide who the invaders are” (paragraph 7).
- A. CORRECT.** The fact that many plants and animals have no choice but to seek out “climate conditions they can tolerate” (paragraph 8) makes it much harder to decide whether to call these species invaders.
 - B.** Incorrect. The fact that many domestic crops are non-native species has nothing to do with climate change affecting our discernment of which species are invaders.
 - C.** Incorrect. The description in paragraph 11 of native and non-native species interacting never suggests that climate change is a factor in these interactions and never suggests that climate change muddies our understanding of which species is native and which is non-native.
 - D.** Incorrect. While the example of Mark Davis so thoroughly changing his beliefs about non-native species is a powerful one, the role that climate change might have played in this reversal is never discussed.
-

- 54.** The question asks what the author’s use of cause and effect in paragraphs 10–11 mainly emphasizes.
- E.** Incorrect. The examples of cause and effect discussed in paragraphs 10–11, such as the spartina grass helping the clapper rail and the Japanese white-eye bird pollinating Hawaiian flowers, are all instances in which non-native species have helped their new environments.
 - F.** Incorrect. While paragraph 10 does mention that efforts to eradicate the non-native spartina grass hurt the native clapper rail shorebird, the main emphasis in both paragraphs 10–11 is on the fact that certain non-native species have helped native species.
 - G. CORRECT.** Paragraphs 10–11 focus on several examples of non-native species that have helped endangered native species flourish: non-native spartina grass providing “important habitat for the endangered California clapper rail” (paragraph 10), non-native tamarisk shrubs providing nesting places for the endangered southwestern willow flycatcher (paragraph 11), and the non-native Japanese white-eye bird pollinating Hawaiian flowers (paragraph 11).
 - H.** Incorrect. While paragraphs 10–11 describe several interactions between non-native and native species, they never discuss monitoring these interactions.

55. The question asks which sentence from the excerpt supports the idea that some species are able to adjust to change.
- A. Incorrect. This sentence discusses native gardens, featuring native species, which presumably have no need to adjust to change.
 - B. **CORRECT.** This sentence demonstrates that some species—in this case, Hawaiian flowers—have adapted well to change: the flowers thrive thanks to new pollinators.
 - C. Incorrect. This sentence focuses on the importance of “preventing extinctions and preserving biodiversity” but does not address the fact that being able to adjust to change is one thing that helps achieve those goals.
 - D. Incorrect. Far from demonstrating that some species can adjust to change, this sentence discusses species that were not adjusting to the loss of large tortoises and were therefore “on the decline.”
-
56. The question asks how the details in the section “A Good Thing, Not the Only Thing” convey a central idea of the excerpt.
- E. Incorrect. While paragraph 15 does discuss introducing non-native Aldabra tortoises to replace native tortoises that no longer exist, the real point of this section is to show that non-native species can sometimes help support native species that still exist but are struggling. In this case, the Aldabra tortoises are now moving seeds around for the fruiting plants on the islands where they have been introduced.
 - F. **CORRECT.** This section discusses situations in which non-native species should be kept (as in the example of the Aldabra tortoises in paragraph 15) but also asserts that “most of the time . . . conserving species still means focusing on supporting them in their historical habitats, planting natives and removing non-natives” (paragraph 16). This section makes the point that the issue of non-natives needs to be considered on a case-by-case basis.
 - G. Incorrect. This section does not claim that non-native species always or even usually enhance biodiversity; rather, it states that “in some cases we can best serve biodiversity by leaving the non-natives alone or even—brace yourself, now—introducing them on purpose” (paragraph 14), later adding that “most of the time . . . conserving species still means focusing on supporting them in their historical habitats, planting natives and removing non-natives” (paragraph 16).
 - H. Incorrect. While the section happens to give a good example of a habitat that supports both native and non-native species (the islands of Mauritius), it never suggests that being able to do so is a defining characteristic of healthy habitats.

- 57.** The question asks how the chart provides additional support for a central idea of the excerpt.
- A.** Incorrect. The chart indicates that the public tends to become aware of non-native species once eradication is “unlikely or impossible,” not strictly impossible. Furthermore, this idea is not a central idea of the excerpt.
 - B. CORRECT.** The chart strongly suggests that once “rapid increase in populations” of non-native species has occurred, eradication will be “unlikely or impossible.”
 - C.** Incorrect. While the chart does show that non-native species can eventually be impossible to eradicate, it never addresses the issue of how the non-native species might be destructive to their new environments.
 - D.** Incorrect. The chart shows how non-native species become harder and harder to remove as their population grows but does not explain how any conservation groups have approached their removal.

- 58. (1.18)** To determine the area of a circle, begin by finding the radius of the circle, which is half of the diameter.

The radius of the entire circle is

$$1\frac{1}{4} \text{ in.} \div 2 = \frac{5}{8} \text{ in.}, \text{ so the area of the entire circle is } \pi\left(\frac{5}{8}\right) \text{ in.}^2 = \frac{25}{64}\pi \text{ in.}^2$$

The radius of the hole in the circle is

$$\frac{1}{4} \text{ in.} \div 2 = \frac{1}{8} \text{ in.}, \text{ so the area of the hole in the circle} = \pi\left(\frac{1}{8}\right) \text{ in.}^2 = \frac{1}{64}\pi \text{ in.}^2$$

To determine the area of the shaded region, subtract the area of the hole in the circle from the area of the entire circle:

$$\begin{aligned} & \left(\frac{25}{64}\right)\pi \text{ in.}^2 - \left(\frac{1}{64}\right)\pi \text{ in.}^2 = \\ & \left(\frac{24}{64}\right)\pi \text{ in.}^2 = \\ & \left(\frac{3}{8}\right)\pi \text{ in.}^2 = \\ & \left(\frac{3}{8}\right) \text{ in.}^2(3.14) = \\ & 1.175 \text{ in.}^2 \end{aligned}$$

1.175 square inches rounded to the nearest hundredth of a square inch = 1.18 square inches

- 59. (1.5)** Let x represent the number of hours the electrician can work.

The cost for the number of hours worked is \$60 times the number of hours worked, x . The sum of the one-time trip charge (\$45) and the cost of the number of hours worked ($60x$) must be less than or equal to \$135. Express this relationship as an inequality:

$$45 + 60x \leq 135$$

Solve the inequality for x :

$$\begin{aligned} 45 + 60x & \leq 135 \\ 60x & \leq 90 \\ x & \leq \frac{90}{60} = \frac{9}{6} = \frac{3}{2} \end{aligned}$$

Written as a decimal, $\frac{3}{2} = 1.5$.

60. (12) Determine the greatest temperature listed for the six days:

Of 7, 4, 1, (-2), (-5), and 3, the greatest value is 7 because its location is farthest to the right on a number line.

Greatest temperature = 7° F

Determine the lowest temperature listed for the six days:

Of 7, 4, 1, (-2), (-5), and 3, the lowest value is (-5) because its location is farthest to the left on a number line.

Lowest temperature = $(-5)^{\circ}$ F

Determine the difference between the two temperatures:

$$7^{\circ}\text{ F} - (-5)^{\circ}\text{ F} = 7^{\circ}\text{ F} + 5^{\circ}\text{ F} = 12^{\circ}\text{ F}$$

- 61. (3)** To determine the cost of a gallon of orange juice, begin by finding the total number of ounces in the 6-pack of bottles:

$$5.5 \text{ oz} \times 6 = 33 \text{ oz}$$

So, 33 oz of orange juice costs \$1.79.

There are 128 oz in 1 gallon. Set up a proportion using the \$1.79 cost per 33 oz of orange juice and the unknown cost (x) per 1 gallon of orange juice:

$$\frac{33 \text{ oz}}{\$1.79} = \frac{128 \text{ oz}}{x}$$

Cross multiply to solve for x in the proportion:

$$(33) \times (x) = (\$1.79) \times (128)$$

$$33x = \$229.12$$

$$x = \$6.94$$

So, the orange juice costs \$6.94 per gallon, and the milk costs \$3.99 per gallon.

Subtract the cost per gallon of milk from the cost per gallon of orange juice.

$$\$6.94 - \$3.99 = \$2.95$$

Round the difference to the nearest dollar.

\$2.95 rounds to \$3.

- 62. (15)** Determine the range by subtracting the minimum value on the box plot from the maximum value on the box plot:

Maximum value = 84° F, Minimum value = 39° F

$$84^{\circ} \text{ F} - 39^{\circ} \text{ F} = 45^{\circ} \text{ F}$$

Determine the interquartile range by subtracting the lower quartile value on the box plot from the upper quartile value on the box plot:

Upper Quartile Value = 78° F, Lower Quartile Value = 48° F

$$78^{\circ} \text{ F} - 48^{\circ} \text{ F} = 30^{\circ}$$

Determine the difference between the range (45° F) and the interquartile range (30° F):

$$45^{\circ} \text{ F} - 30^{\circ} \text{ F} = 15^{\circ} \text{ F}$$

- 63. (D)** Determine the prime factors of 756 using a factor tree:

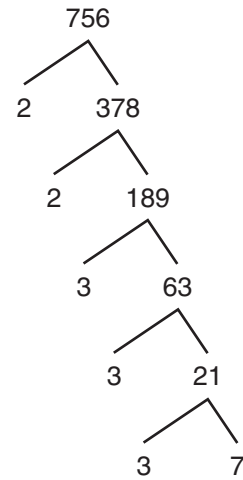

The prime factors are 2, 2, 3, 3, 3, and 7, or $2 \cdot 2 \cdot 3 \cdot 3 \cdot 3 \cdot 7$, which can be expressed using exponents as $2^2 \cdot 3^3 \cdot 7$.

64. (F) First, substitute -2 for x and 2 for y .

$$\frac{(-2)^2(2)^6}{(-2)(2)^2}$$

Then, simplify.

$$\frac{(-2)(-2)(2)^2(2)^4}{(-2)(2)^2}$$

$$\frac{(-2)(2)^4}{1}$$

$$\frac{-2 \times 16}{1}$$

$$-32$$

65. (B) The quantity $(8 \div m)$ means the same as $\frac{8}{m}$, so the equation can be rewritten:

$$\left(\frac{8}{m}\right) + 4 = 20$$

Subtract 4 from both sides:

$$\left(\frac{8}{m}\right) = 16$$

Multiply both sides of the equation by m :

$$8 = 16m$$

Solve for m :

$$\left(\frac{8}{16}\right) = m$$

Simplify:

$$\left(\frac{8(\div 8)}{16(\div 8)}\right) = \left(\frac{1}{2}\right)$$

- 66. (H)** Simplify $6x = x - 1,680$. First, subtract x from both sides of the equation. Then, divide both sides by 5.

$$6x - x = x - x - 1,680$$

$$5x = -1,680$$

$$\frac{5x}{5} = \frac{-1,680}{5}$$

$$x = -336$$

- 67. (C)** Determine the total cost of the car by adding the down payment to the total monthly payments over 3 years.

There are 12 months in a year, so multiply (12 months/year \times 3 years) to get a total of 36 months. Determine the total monthly payments by multiplying the monthly payment (\$275) \times the total number of months (36):

$$275 \times 36 = 9,900$$

Determine the total cost of the car by adding the down payment (\$1,200) to the total monthly payments (\$9,900):

$$9,900 + 1,200 = 11,100$$

The total cost of the car is \$11,100.

- 68. (E)** In a parallelogram, any two adjacent angles are supplementary, so the sum of the two given angles is equal to 180° .

Write an equation showing that the sum of $3x^\circ$ and $2x^\circ$ is equal to 180° :

$$3x + 2x = 180$$

Solve for x :

$$5x = 180$$

$$\frac{5x}{5} = \frac{180}{5}$$

$$x = 36$$

- 69. (D)** Write an expression to represent the number of occupants after 20 stops. Then, simplify the expression.

$$R + (20 \times 3) = R + 60$$

Write an expression to represent the number of occupants after 4 stops. Then, simplify the expression.

$$R + (4 \times 3) = R + 12$$

Write an equation that shows that the number of occupants after 20 stops is 3 times the number of occupants after 4 stops. Then, solve for R .

$$R + 60 = 3(R + 12)$$

$$R + 60 = 3R + 36$$

$$60 = 2R + 36$$

$$24 = 2R$$

$$12 = R$$

Write an expression to represent the number of occupants after 10 stops. Then, substitute 12 for R and evaluate.

$$R + (10 \times 3)$$

$$12 + (10 \times 3) = 12 + 30 = 42$$

- 70. (H)** Since Jay sold n tickets and Pilar sold 3 times the number of tickets Jay sold, Pilar sold $3n$ tickets.

Then, since together Jay and Pilar sold 10 more tickets than Amie, subtract 10 from $(n + 3n)$ to get the expression that shows how many tickets Amie sold.

$$(n + 3n) - 10$$

Then combine like terms.

$$4n - 10$$

- 71. (C)** Divide to solve for x :

$$\frac{(-12)}{6} > \frac{6x}{6}$$

$$-2 > x$$

Rewriting $-2 > x$ with the x term first requires reversing the inequality symbol in order to keep the meaning “ x is less than (-2) ”:

$$x < -2$$

-
- 72. (E)** To find the value of x in terms of y , solve $5(x - 6y) = 50y$ for x . Begin by distributing 5 on the left side of the equation:

$$(5 \times x) - (5 \times 6y) = 50y$$

$$5x - 30y = 50y$$

Solve for the value of x :

$$5x = 80y$$

$$\frac{5x}{5} = \frac{80y}{5}$$

$$x = 16y$$

- 73. (C)** Determine the two missing side lengths on the scale drawing:

All corners are right angles, so the figure can be divided into rectangles with opposite sides that are congruent in length. This means the sum of the shorter vertical sides on the left and in the center of the figure (2 in. + x in.) must equal the length of the longer vertical side on the right side of the figure (5 in.):

$$2 + x = 5$$

$$x = 3$$

So, the missing vertical side length of the figure is 3 in.

Again, because opposite sides of a rectangular figure are congruent in length, the sum of the shorter horizontal sides in the middle and bottom of the figure (3 in. + x in.) must equal the length of the longer horizontal side on the top of the figure (6 in.):

$$3 + x = 6$$

$$x = 3$$

So, the missing horizontal side length of the figure is 3 in.

Determine the perimeter by adding all the

side lengths of the figure:

$$6 + 2 + 3 + 3 + 3 + 5 = 22$$

This is a scale drawing in which

$\frac{1}{2}$ in. = 25 ft. Write a proportion to determine the value of x , the unknown number of feet that is represented by 22 in.:

$$\frac{(\frac{1}{2}) \text{ in.}}{25 \text{ ft}} = \frac{22 \text{ in.}}{x}$$

Cross multiply and solve the equation for x :

$$(\frac{1}{2})(x) = (22)(25)$$

$$\frac{1}{2}x = 550$$

$$x = 1,100$$

- 74. (G)** Maria's rate of speed is given as 15 miles per hour. Since 1 hour is equivalent to 60 minutes, her rate of speed, in miles per minute, can be determined.

$$\frac{15 \text{ miles}}{1 \text{ hour}} = \frac{15 \text{ miles}}{60 \text{ minutes}} = \frac{1 \text{ mile}}{4 \text{ minutes}},$$

or $\frac{1}{4}$ mile per minute.

Therefore, it takes Maria 4 minutes to ride 1 mile.

The distance to school is 6 miles, so it will take $6 \times 4 = 24$ minutes to ride to school.

- 75. (C)** The triangle formed by line p , line m , and the line segment connecting the two contains a 73° angle, a right angle (90°), and a missing angle measuring x° . The sum of the interior angles of a triangle is 180° , so begin by finding the value of x :

$$180^\circ = 73^\circ + 90^\circ + x$$

$$180^\circ = 163^\circ + x$$

$$17^\circ = x$$

Line m is a straight line, so it has a measure of 180° . The 17° angle from the triangle and the adjacent angle outside the triangle are supplementary, so they have a sum of 180° . Let s represent the measure of the adjacent angle outside the triangle. The value of s can be determined by subtracting:

$$s = 180^\circ - 17^\circ$$

$$s = 163^\circ$$

Given that n and p are parallel lines and that they have been cut by a transversal, line m , then corresponding angles are congruent. Angles r and s are corresponding angles, so the value of r is congruent to the value of s , which is 163° .

-
- 76. (G)** PQRS is a parallelogram in which \overline{PS} is a base and \overline{QT} is an altitude. The base is 34 cm in length, and the height is the length of the altitude, so the height is 18 cm.

To determine the area of a parallelogram, multiply the base \times the height:

$$34 \text{ cm} \times 18 \text{ cm} = 612 \text{ cm}^2$$

- 77. (B)** Determine the total number of stamps in 5 albums holding 576 stamps:

$$5 \times 576 = 2,880$$

Determine the total number of stamps in 6 albums holding 378 stamps:

$$6 \times 378 = 2,268$$

Subtract 2,268 from 2,880 to find the number of stamps that will be left over:

$$2,880 - 2,268 = 612$$

- 78. (H)** Begin by multiplying 135.28 by 10:

$$135.28 \times 10 = 1,352.8$$

Add 0.5:

$$1,352.8 + 0.5 = 1,353.3$$

Drop the digits after the decimal point, so 1,353.3 becomes 1,353.

Divide by 10:

$$1,353 \div 10 = 135.3$$

- 79. (B)** Substitute -2 for each value of x in the expression:

$$\begin{aligned} & |(-2) + (-2)^2 + (-2)^3| \\ & \text{minus} \\ & |(-2) + 2(-2) + 3(-2)| \end{aligned}$$

Evaluate the terms involving exponents:

$$\begin{aligned} & |(-2) + 4 + (-8)| \\ & \text{minus} \\ & |(-2) + 2(-2) + 3(-2)| \end{aligned}$$

Evaluate the terms involving multiplication:

$$\begin{aligned} & |(-2) + 4 + (-8)| \\ & \text{minus} \\ & |(-2) + (-4) + (-6)| \end{aligned}$$

Simplify the expression:

$$\begin{aligned} & |2 + (-8)| - |(-2) + (-10)| \\ & |-6| - |-12| \end{aligned}$$

The absolute value of (-6) is 6, and the absolute value of (-12) is 12, so $|-6| - |-12|$ is the equivalent of subtracting 12 from 6:

$$6 - 12 = (-6)$$

- 80. (F)** Simplify the expression.

$3 + (-3)$ is the equivalent of subtracting 3 from 3, and $3 - (-3)$ is equivalent of adding 3 to 3:

$$\frac{3 + (-3)}{3 - (-3)} = \frac{3 - 3}{3 + 3} = \frac{0}{6}$$

The zero property of division states that zero divided by any number equals zero, so $\frac{0}{6} = 0$.

- 81. (C)** Since the greatest number of decimal places is 2 (hundredths), multiply both terms by 100, and then divide:

$$\begin{aligned} & 12.96(100) \div 0.08(100) = \\ & 1,296 \div 8 = \\ & 162 \end{aligned}$$

- 82. (E)** \overline{MN} begins at 1 and ends at 7.

Determine the length of \overline{MN} :

$$7 - 1 = 6$$

The midpoint of a line segment is located exactly halfway between the two endpoints. Since \overline{MN} is 6 units in length, the two endpoints are 6 units apart. Determine the location of the midpoint, in relation to each endpoint, by dividing 6 by 2:

$$6 \div 2 = 3$$

The location of the midpoint of \overline{MN} is 3 units from either endpoint. Find the midpoint by either adding 3 to the location of M (1) or subtracting 3 from the location of N (7):

$$1 + 3 = 4$$

$$7 - 3 = 4$$

The midpoint of \overline{MN} is located at 4.

\overline{RS} begins at 3 and ends at 6. Determine the length of \overline{RS} :

$$6 - 3 = 3$$

Since \overline{RS} is 3 units in length, the two

endpoints are 3 units apart. Determine the location of the midpoint, in relation to each endpoint, by dividing 3 by 2:

$$3 \div 2 = 1.5$$

The location of the midpoint of \overline{RS} is 1.5 units from either endpoint. Find the midpoint by either adding 1.5 to the location of R (3) or subtracting 1.5 from the location of S (6):

$$3 + 1.5 = 4.5$$

$$6 - 1.5 = 4.5$$

The midpoint of \overline{RS} is located at 4.5.

Determine the distance between the two midpoints by subtracting:

$$4.5 - 4 = 0.5$$

0.5 is equivalent to $\frac{1}{2}$, making the distance between the two midpoints $\frac{1}{2}$ unit.

- 83. (D)** Each of the three expressions must be considered:

Expression I: $s - t$, where s is a positive integer and t is a negative integer:

Subtracting a negative integer is the equivalent of adding a positive integer, so $s - (-t)$ is equivalent to finding the value of $s + t$, which must result in a positive number.

Expression II: st^2 , where s is a positive integer and t is a negative integer:

Squaring a negative integer results in a positive integer, so $s(-t)^2$ is equivalent to finding the value of st^2 , which must result in a positive number.

Expression III: s^t , where s is a positive integer and t is a negative integer:

A negative exponent results in the reciprocal of the same exponential expression, so $s^{(-t)}$ is equivalent to finding the value of $\frac{1}{s^t}$, which must result in a positive number.

Therefore, Expressions I, II, and III must all result in a positive number.

- 84. (G)** Evaluate the expression by multiplying the terms in the numerator and the terms in the denominator. The product of two negative values is positive:

$$\frac{(-3) \times (-2)}{4 \times 5} = \frac{6}{20}$$

Simplify the result:

$$\frac{6 \div 2}{20 \div 2} = \frac{3}{10}$$

- 85. (D)** The sum of all transactions (\$70) includes the income data (positive values) and the expense data (negative values). Write an equation to determine the value of p by adding all the income data and subtracting all the expense data:

$$400 \cdot 2 + 95 + p - 120 \cdot 4 - 500 = 70$$

Simplify the expression to determine the value of p :

$$800 + 95 + p - 480 - 500 = 70$$

$$895 + p - 980 = 70$$

$$p - 85 = 70$$

$$p = 155$$

86. (F) A yardstick is 1 yard in length.

$$1 \text{ yd} = 3 \text{ ft}$$

$$4 \text{ yd} = 12 \text{ ft}$$

A 12-inch ruler is 1 foot in length.

Two 12-inch rulers is 2 feet in length.

$$12 \text{ ft} + 2 \text{ ft} = 14 \text{ ft}$$

87. (A) The ratios of the items are equal, so they can be expressed using a proportion.

Let a represent the number of apples, o the number of oranges, c the number of cherries, and w the number of walnuts.

Write a proportion showing apples:oranges is equal to cherries:walnuts:

$$\frac{a}{o} = \frac{c}{w}$$

Substitute the given values for oranges (6), cherries (16), and walnuts (48):

$$\frac{a}{6} = \frac{16}{48}$$

Cross multiply to form an equation to solve for the number of apples (a):

$$(a \times 48) = (16 \times 6)$$

Solve for the value of a :

$$48a = 96$$

$$a = 2$$

- 88. (F)** The ratio of paintings to drawings to photographs is 3:5:4.

First, determine the number of actual paintings and photographs.

Since the number of actual drawings is 45, each ratio is multiplied by 9, since $5 \times 9 = 45$.

Type	Ratio	Actual Number
Paintings	3	27
Drawings	5	45
Photographs	4	36

Then, add the actual number of paintings and photographs.

$$27 + 36 = 63$$

- 89. (C)** It takes $\frac{5}{6}$ yard of fabric to make $\frac{3}{8}$ foot of curtain width.

To find the ratio of 1 foot of curtain width to $\frac{3}{8}$ foot of curtain width $\left(1:\frac{3}{8}\right)$, divide.

$$1 \div \frac{3}{8} = 1 \times \frac{8}{3} = \frac{8}{3}$$

So the amount of fabric needed for 1 foot of curtain width is $\frac{8}{3}$ times the amount needed for $\frac{3}{8}$ foot of curtain width.

$$\frac{8}{3} \times \frac{5}{6} = \frac{40}{18}$$

$$\frac{40 \div 2}{18 \div 2} = \frac{20}{9}$$

The amount of fabric needed for 1 foot of curtain width is $\frac{20}{9}$ yards.

-
- 90. (H)** The graph of any proportional line must intersect the origin, $(0, 0)$.

The only line on the coordinate plane that contains $(0, 0)$ is \overleftrightarrow{TR} .

Both point $T(1, 4)$ and point $R(2, 8)$ have a y -value that is 4 times the x -value, and every point on the line fits the proportional equation $y = 4x$.

When $x = 0$, $y = 4(0)$. So the line contains the origin, $(0, 0)$.

- 91. (C)** The x -axis represents the weight, in pounds (lb), of ice purchased, and the y -axis represents the cost of the ice, in dollars.

The x -value in the point $(10, 1.5)$ represents 10 lb of ice, and the y -value represents 1.5 dollars, or \$1.50.

Therefore, the cost of 10 lb of ice is \$1.50.

- 92. (F)** The x -axis represents the time, in hours, the clerk enters information into the computer, and the y -axis represents the number of keystrokes the clerk makes.

The x -value in $(1.5, 10500)$ gives 1.5 hours as the amount of time the clerk enters information.

The y -value gives 10,500 as the number of keystrokes made by the clerk.

Since the graph is a proportional line, the clerk's rate is 10,500 keystrokes in each 1.5 hours of entering information.

- 93. (D)** Each of the options 0, 2, 3, and 6 must be considered:

Option A: In the case of 0, the three-digit whole number is 270. Divide 270 by both 3 and 4:

$$270 \div 3 = 90 \text{ (or } 90R0\text{)}$$

$$270 \div 4 = 67\frac{1}{2} \text{ (or } 67R2\text{)}$$

Dividing 270 by 3 results in a remainder of 0, but dividing 270 by 4 results in a remainder of 2, so 0 cannot be the missing digit.

Option B: In the case of 2, the three-digit whole number is 272. Divide 272 by both 3 and 4:

$$272 \div 3 = 90\frac{2}{3} \text{ (or } 90R2\text{)}$$

$$272 \div 4 = 68 \text{ (or } 68R0\text{)}$$

Dividing 272 by 4 results in a remainder of 0, but dividing 272 by 3 results in a

remainder of 2, so 2 cannot be the missing digit.

Option C: In the case of 3, the three-digit whole number is 273. Divide 273 by both 3 and 4:

$$273 \div 3 = 91 \text{ (or } 91R0\text{)}$$

$$273 \div 4 = 68\frac{1}{4} \text{ (or } 68R1\text{)}$$

Dividing 273 by 3 results in a remainder of 0, but dividing 273 by 4 results in a remainder of 1, so 3 cannot be the missing digit.

Option D: In the case of 6, the three-digit whole number is 276. Divide 276 by both 3 and 4:

$$276 \div 3 = 92 \text{ (or } 92R0\text{)}$$

$$276 \div 4 = 69 \text{ (or } 69R0\text{)}$$

Dividing 276 by 3 results in a remainder of 0, and dividing 276 by 4 results in a remainder of 0, so 6 is the missing digit.

- 94. (H)** First, determine the missing percentage for “milk and eggs” consumed, based on the circle graph.

$$\begin{aligned}100 - (38 + 10 + 10 + 8 + 4) &= \\100 - 70 &= \\30\end{aligned}$$

Then, determine 30% of 1,840 pounds. Multiply:

$$1,840 \times \frac{30}{100} = 552$$

-
- 95. (C)** The fraction $\frac{191}{2000}$ represents the 191 high school seniors out of 2,000 enrolled in the Honor Society.

To determine the percent, convert the fraction to a decimal. Then, rewrite the decimal as a percent.

$$\frac{191}{2000} = 0.0955 = 9.55\%$$

- 96. (E)** First, determine the total number of visitors.

$$360 + 340 + 210 + 290 = 1200$$

The largest group is 360 (Male Children).

Find the percent that represents $\frac{360}{1200}$.

$$\frac{360}{1200} \times \frac{100}{1}\% = \frac{360}{12} \times \frac{1}{1}\% = 30\%$$

-
- 97. (A)** First, determine what fraction of the sample were red tiles, given 18 of the 120 tiles drawn were red.

$$\frac{18 \div 6}{120 \div 6} = \frac{3}{20}$$

To predict how many of the actual 40 tiles in the bag are red, multiply 40 by the fraction of red tiles in the sample.

$$\frac{3}{20}(40) = \frac{120}{20} = 6$$

- 98. (G)** First, determine what percentage of the total attendees last year were children.

$$\frac{1,750}{5,000} = \frac{35}{100} = 0.35, \text{ or } 35\%$$

The best estimate based on last year's attendance is 35% of 100.

$$0.35 \times 100 = 35$$

- 99. (B)** The tree diagram shows that each of the 3 randomly selected students is from Classroom A or Classroom B. So the first chosen is either A or B, represented by the left column of the diagram.

The second student is either A or B, so if the first is A, the first two chosen will be either AA or AB. If the first is B, then the first two chosen will be either BA or BB, represented by the middle column.

The third student is either A or B, so if the first 2 were AA, the group of 3 would be either AAA or AAB. These outcomes are represented by the top two boxes of the right column. This pattern is followed so that 8 distinct outcomes can be visualized in order:

AAA, AAB, ABA, ABB, BAA, BAB, BBA, BBB

Since the order does not matter, there are 3 groups made up of 2 students from Classroom A and 1 student from Classroom B: AAB, ABA, and BAA.

Out of 8 possible outcomes, 3 outcomes have 2 students from Classroom A and 1 student from Classroom B. Therefore, the probability is 3 out of 8, or $\frac{3}{8}$.

100. (E) The probability of drawing a red marble at random from a bag of 15 marbles (11 blue and 4 red) is shown:

$$P(\text{Red}) = \frac{4 \text{ red marbles}}{15 \text{ total marbles}} = \frac{4}{15}$$

When the red marble is replaced in the bag, the probability of picking a red marble is unchanged, $P(\text{Red}) = \frac{4}{15}$.

The two events are independent, so the multiplication rule of probability applies.

$$P(\text{Red}) \cdot P(\text{Red}) = \frac{4}{15} \cdot \frac{4}{15} = \frac{16}{225}$$

101. (C) One report is assigned for each of 4 subjects, and each subject has a specified number of topic choices:

- 5 choices for Geography
- 3 choices for English
- 1 choice for Science
- 2 choices for Math

The basic counting principle (product rule) applies since the number of choices for each subject is independent of the choices for the other subjects. The number of different sets of 4 reports possible is the product.

$$5 \times 3 \times 1 \times 2 = 30$$

102. (F) First, determine the number of cards in the remaining deck:

$$52 - 12 = 40$$

Next, determine the number of hearts left in the remaining deck:

$$13 - 3 = 10$$

Last, determine the probability of drawing a heart from the remaining deck:

$$\frac{10 \text{ hearts remaining}}{40 \text{ total cards remaining}} = \frac{10}{40} = \frac{1}{4}$$

103. (A) The flavor most likely to be picked at random is butterscotch, because its probability is the greatest of the probabilities in the list. More than half the candies in the bowl are butterscotch.

104. (E) Apply the properties of equality to solve for w .

$$p = \frac{1}{r}w + f$$

Subtract f from both sides of the equation.

$$p - f = \frac{1}{r}w$$

Multiply both sides by r .

$$r(p - f) = r\left(\frac{1}{r}w\right)$$

$$r(p - f) = w$$

$$w = r(p - f)$$

- 105. (C)** Determine the fraction of undamaged boxes in the sample, given 8 of the 20 boxes are damaged.

$$\frac{20 - 8}{20} = \frac{12}{20} = \frac{3}{5} \text{ or } 0.6$$

Subtract the number of boxes in the sample from 170.

$$170 - 20 = 150$$

Basing the prediction of undamaged boxes on the sample, multiply the number of boxes **not** in the sample by the fraction of undamaged boxes in the sample.

$$150 \times 0.6 = 90$$

- 106. (F)** Solve the inequality $2b + 8 \geq 25$.

$$2b + 8 - 8 \geq 25 - 8$$

$$2b \geq 17$$

$$\frac{2b}{2} \geq \frac{17}{2}$$

$$b \geq 8.5$$

Since the number of baskets made must be a whole number, the fewest 2-point baskets, b , he must make is 9.

- 107. (D)** Let x represent the number of ounces Nadia's letter weighed. The first ounce costs \$0.55, so $(x - 1)$ represents the number of ounces that cost \$0.15 each.

Given that the total cost is \$1.00, the equation that describes the situation can be written and solved as shown.

$$0.55 + 0.15(x - 1) = 1.00$$

$$0.55 + 0.15x - 0.15 = 1.00$$

$$0.15x = 1.00 - 0.55 + 0.15$$

$$0.15x = 0.60$$

$$\frac{0.15x}{0.15} = \frac{0.60}{0.15}$$

$$x = 4$$

So the letter Nadia mailed weighed 4 ounces.

- 108. (E)** The unit rate (cost per orange) can be determined by dividing the cost of x oranges by x .

$$\frac{1.80}{4} = \frac{2.70}{6} = \frac{4.05}{9} = 0.45$$

The unit rate is \$0.45.

109. (A) In this context, the constant of proportionality, p , represents the relationship between b , the number of bottles of water, and n , the number of players on the team.

The number of bottles of water is the product of the constant of proportionality and the number of players.

The equation that represents this relationship is $b = pn$.

110. (F) Subtract to determine the amount of increase in Malik's hourly pay if he changes jobs.

$$12 - 10 = 2$$

Divide the increase amount by the original hourly pay rate.

$$2 \div 10 = 0.2$$

Multiply the quotient by 100 to express the decimal amount as a percentage.

$$0.2 \times 100 = 20$$

111. (C) Set up a proportion to solve:

$$\begin{aligned}\frac{1 \text{ in.}}{2.5 \text{ cm}} &= \frac{x \text{ in.}}{10 \text{ cm}} \\ 2.5x &= 10 \\ x &= 10 \div 2.5 \\ x &= 4\end{aligned}$$

10 centimeters is approximately 4 inches.

112. (F) The constant of proportionality is determined by dividing the number of millimeters by the number of days:

$$\frac{20 \text{ mm}}{8 \text{ days}} = \frac{20}{8} = 2.5 \text{ mm/day}$$

113. (A) The first table is the only one with a constant of proportionality, $\frac{3}{8}$.

In each ordered pair, $\frac{3}{8}x = y$.

$$\begin{aligned}\frac{3}{8}(0) &= 0 \\ \frac{3}{8}(4) &= \frac{12}{8} = \frac{3}{2} \\ \frac{3}{8}(8) &= \frac{24}{8} = 3\end{aligned}$$

114. (F) To find the distance around a circle if the radius is known, use the formula for circumference, $C = 2\pi r$.

$$C = 2(3.14)(5) = 31.4$$

You can read explanations for each answer online here. If you are in Grade 9, you can find examples of additional types of math content you might see on your test here.

Answer Key for Sample Form A

1. A	14. E	27. D	40. H	53. A	66. H	79. B	92. F	105. C
2. G	15. C	28. F	41. D	54. G	67. C	80. F	93. D	106. F
3. B	16. F	29. C	42. E	55. B	68. E	81. C	94. H	107. D
4. E	17. D	30. F	43. C	56. F	69. D	82. E	95. C	108. E
5. A	18. H	31. B	44. G	57. B	70. H	83. D	96. E	109. A
6. F	19. B	32. E	45. A	58. 1.18	71. C	84. G	97. A	110. F
7. A	20. F	33. C	46. E	59. 1.5	72. E	85. D	98. G	111. C
8. F	21. A	34. H	47. B	60. 12	73. C	86. F	99. B	112. F
9. D	22. E	35. B	48. G	61. 3	74. G	87. A	100. E	113. A
10. F	23. C	36. H	49. D	62. 15	75. C	88. F	101. C	114. F
11. B	24. E	37. B	50. F	63. D	76. G	89. C	102. F	
12. H	25. A	38. F	51. A	64. F	77. B	90. H	103. A	
13. C	26. H	39. C	52. H	65. B	78. H	91. C	104. E	

The New York City Department of Education

2023 Specialized High School Admissions Test

GENERAL DIRECTIONS

Student Name: _____

Identifying Information

Turn to Side 1 of the answer sheet.

Notify the proctor immediately if you are ill or should not be taking this test. Do not sign the statement or begin the test. Return your answer sheet to the proctor.

Line 1: Read the statement and sign your name in the space following the word “signature.” Do not print your name.

Line 2: Print today’s date, using the numbers of the month, the day, and the year. For example, the date September 21, 2022, would be 9-21-22.

Line 3: Print your birth date, using the numbers of the month, the day, and the year. For example, a birth date of March 1, 2006, would be 3-1-06.

Grid 4: Print the letters of your first name, or as many as will fit, in the boxes. If you have a middle initial, print it in the box labeled “MI.” Then print the letters of your last name, or as much as will fit, in the boxes provided. Below each box, fill in the circle that contains the same letter as the box. If there is a space or a hyphen in your name, fill in the circle under the appropriate blank or hyphen.

Make dark marks that completely fill the circles. If you change a mark, be sure to erase the first mark completely.

Grid 5:

1. Print the name of the school where you are now enrolled in the space at the top of the grid.
2. In the boxes marked “SCHOOL CODE,” print the six-digit code that identifies your school. Below each box, fill in the circle that contains the same letter or number as the box. (You can find your school code on your Test Ticket. If it is not there, tell the proctor, and the proctor will get the school code for you.)
3. If you attend a private or parochial school, fill in the circle marked “P.”

Grid 6: Complete the grid with your date of birth. Print the first three letters of the month in the first box, the number of the day in the next box, and the year in the last box. Then fill in the corresponding circles.

Grid 7: Print your student ID number in Grid 7. You can find your student ID number on your Test Ticket. In the boxes, print your nine-digit student ID number. Below each box, fill in the circle containing the same number as in the box.

Grid 8: In most cases, Grid 8 is already filled in for you. If it is not, copy the letter and numbers shown in the upper-right corner of your test booklet into the boxes. Below each box, fill in the circle containing the same letter or number as the box.

Now review Side 1 to make sure you have completed all lines and grids correctly. Review each column to see that the filled-in circles correspond to the letters or numbers in the boxes above them.

GENERAL DIRECTIONS, continued

Print your test booklet letter and numbers, and your name, first name **first**, in the spaces provided at the top of Side 2 of the answer sheet.

Marking Your Answers

- Mark each of your answers on the answer sheet in the row of circles matching the question number printed in the test booklet.
- Use only a Number 2 pencil.
- If you change an answer, be sure to erase it completely.
- Be careful to avoid making any stray pencil marks on your answer sheet. **Do not make any marks on your answer sheet other than filling in your answer choices.**
- Each question has only one correct answer. If you mark more than one circle in any answer row, that question will be scored as incorrect.

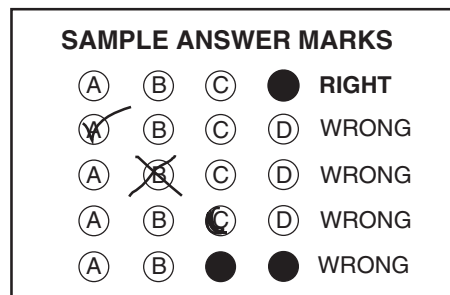

- You can use your test booklet or the provided scrap paper to take notes or solve questions; however, your answers must be recorded on the answer sheet in order to be counted.
- **You will not be able to mark your answers on the answer sheet after time is up, and answers left in the test booklet will not be scored.**

Planning Your Time

- You have 180 minutes to complete the entire test. **How you divide the time between the English Language Arts and Mathematics sections is up to you.**
- If you begin with the English Language Arts section, you may go on to the Mathematics section as soon as you are ready. Likewise, if you begin with the Mathematics section, you may go on to the English Language Arts section as soon as you are ready.
- Be sure to read the directions for each section carefully.
- Each question has only one correct answer. Choose the best answer for each question.
- When you finish a question, go on to the next, until you have completed the last question or run out of time.
- Your score is determined by the number of questions you answer correctly. **Answer every question, even if you may not be certain which answer is correct.**
- Don't spend too much time on a difficult question. Come back to it later if you have time.
- If you complete the test before the test time (180 minutes) is over, you may go back to review questions in either section.
- Students must stay for the entire test session (180 minutes).

DO NOT OPEN THIS BOOKLET UNTIL YOU ARE TOLD TO DO SO



B



Copyright © 2022 Pearson. All rights reserved. No part of this document may be copied, reproduced, modified, or transmitted by any means, electronic or mechanical.

PART 1 — ENGLISH LANGUAGE ARTS

57 QUESTIONS

REVISING/EDITING

QUESTIONS 1-10 (PART A AND PART B)

REVISING/EDITING PART A

DIRECTIONS: Read and answer the following questions. You will be asked to recognize and correct errors so that the sentences or short paragraphs follow the conventions of standard written English. You may write in your test booklet as needed to take notes. You should reread relevant parts of the sentences or paragraphs, while being mindful of time, before marking the **best** answer for each question.

1. Which pair of revisions needs to be made in this paragraph?

(1) Both Italian gelato and American ice cream are delightful treats to have on a hot summer day, but many people wonder: what is the difference between the two? (2) To start with, the butterfat content is much higher in ice cream than it is in gelato, making the Italian treat a wiser decision for people looking to make healthier choices. (3) Additionally, the mixing process, which adds less air to the frozen treat, makes gelato denser than ice cream. (4) Finally, gelato is served 10 to 15 degrees warmer than ice cream, which enhances the texture and flavor of the gelato, and allow it to melt more quickly.

- A. Sentence 1: Delete the colon after **wonder** AND change **is** to **are**.
B. Sentence 2: Delete the comma after **with** AND change **it is** to **they are**.
C. Sentence 3: Delete the comma after **process** AND change **makes** to **make**.
D. Sentence 4: Delete the comma after **gelato** AND change **allow** to **allows**.

2. What is the **best** way to combine the sentences?

- (1) Scientists now believe that Jupiter may have as many as seventy-nine moons.
(2) One of Jupiter’s moons is named Io.
(3) Io has the greatest number of active volcanoes in the solar system.

- E. Io, which is one of Jupiter’s moons, has the greatest number of active volcanoes in the solar system, and scientists now believe that Jupiter may have as many as seventy-nine moons.
- F. Scientists now believe that Jupiter may have as many as seventy-nine moons, and one of them is named Io, which has the greatest number of active volcanoes in the solar system.
- G. Scientists now believe that Jupiter may have as many as seventy-nine moons, including one named Io, which has the greatest number of active volcanoes in the solar system.
- H. Io, a moon with the greatest number of active volcanoes in the solar system, is one of Jupiter’s moons, and scientists now believe that Jupiter may have as many as seventy-nine moons.

3. Which sentence contains an error in its construction and should be revised?

- (1) The blobfish, a creature that certainly resembles its name, is an unusual fish whose body is mostly composed of pink, gelatinous flesh. (2) Because it has very few muscles and its density is close to that of water, the blobfish spends its life floating slightly above the ocean floor. (3) It must wait patiently for whatever edible matter might float by its mouth. (4) The blobfish’s downturned mouth, slimy skin, and pale coloring caused them to be voted the World’s Ugliest Animal in 2013.

- A. sentence 1
- B. sentence 2
- C. sentence 3
- D. sentence 4

4. Which sentence contains an error in its construction and should be revised?

(1) In 1976, the National Basketball Association (NBA) absorbed several teams of the American Basketball Association (ABA), including the New York Nets, who played in the Long Island area at the time. (2) The owner of the Nets decided to take the team to New Jersey after the team had financial troubles, where the team played for thirty-five seasons. (3) The New Jersey Nets had sixteen playoff appearances, including two appearances in the NBA finals. (4) In 2012, the team changed ownership and returned to New York, where the team now plays under the name the Brooklyn Nets.

- E. sentence 1
- F. sentence 2
- G. sentence 3
- H. sentence 4

CONTINUE TO THE NEXT PAGE ►

REVISING/EDITING PART B

DIRECTIONS: Read the text below and answer the questions following it. You will be asked to improve the writing quality of the text and to correct errors so that the text follows the conventions of standard written English. You should reread relevant parts of the text, while being mindful of time, before marking the **best** answer for each question.

Moving through Mountains

(1) An age-old proverb says that necessity is the mother of invention. (2) Centuries of human ingenuity in the face of obstacles prove this to be true. (3) For many years the Swiss Alps, a mountain range spanning southern Switzerland and northern Italy, were such an obstacle. (4) Roads and railways had to navigate around the mountains or through winding tunnels inside the mountains, making the transportation of people and goods difficult and time consuming. (5) In 2016 these burdens were eased with the completion of the Gotthard Base Tunnel.

(6) Construction of the high-speed railway tunnel began in 1996. (7) The tunnel was created through the use of tunnel-boring machines, which are giant drills with a flat rotating head called a cutter head. (8) Each of the tunnel-boring machines used during the construction of the tunnel was about the length of four football fields arranged end-to-end. (9) During the seventeen-year construction period, 28 million tons of rock were removed, enough to rebuild the Great Pyramid of Giza five times. (10) This massive construction project is reported to have cost \$12 billion. (11) After that, 4 million cubic meters of concrete, or enough concrete to build eighty-four Empire State Buildings, were used to construct and support the tunnel.

(12) In a few years, the high-speed railway will carry more than 250 freight trains and 55 passenger trains a day, with most traveling at speeds of around 100 to 125 miles per hour. (13) It will be faster for people to travel between northern and southern Europe. (14) The travel time between the European cities of Zurich, Switzerland, and Milan, Italy, will be reduced by an hour. (15) Many European leaders compare the Gotthard Base Tunnel to the Channel Tunnel, a 33-mile underwater tunnel that connects the United Kingdom and France. (16) While there is no roadway in the Channel Tunnel, people can drive their cars onto special trains that will carry vehicles through to the other side.

(17) Just as traffic congestion in major cities led to the construction of underground local transportation, natural formations, such as mountain ranges, have also sent people underground for faster, easier, and cheaper methods of transportation across larger areas. (18) There is renewed interest in constructing innovative methods of transportation that will help eliminate problems associated with traveling to and from certain areas.

- 5.** Which sentence should be added after sentence 5 to introduce the main topic of the passage?
- A.** The construction of the Gotthard Base Tunnel was approved by Swiss voters in 1992 and was funded by tolls, fuel taxes, and government loans.
 - B.** Leaders from several European countries attended the opening ceremonies for the Gotthard Base Tunnel, a Swiss tunnel.
 - C.** The Gotthard Base Tunnel is the world’s longest and deepest railway tunnel, stretching 35.5 miles straight through the base of the Swiss Alps.
 - D.** The Gotthard Base Tunnel continues to help reduce the number of freight trucks on the roadways in the Swiss Alps.
- 6.** Which sentence should be added to follow and support sentence 7?
- E.** The tunnel-boring machine is helpful to tunnel builders in the modern era and has been an improvement over dynamite.
 - F.** These enormous tunnel-boring machines function somewhat like a cheese grater, with the cutter head grinding slowly through rock and stone.
 - G.** Engineers had considered making a tunnel under the mountains for many years, but it was impossible to do without modern tunnel-boring machines.
 - H.** Different types of cutter heads are used with tunnel-boring machines depending on the geology of the area where the tunnel is being created.
- 7.** Where should sentence 11 be moved in order to improve the organization of the second paragraph (sentences 6–11)?
- A.** to the beginning of the paragraph (before sentence 6)
 - B.** between sentences 6 and 7
 - C.** between sentences 8 and 9
 - D.** between sentences 9 and 10
- 8.** Which sentence presents information that shifts away from the main topic of the third paragraph (sentences 12–16) and should be removed?
- E.** sentence 13
 - F.** sentence 14
 - G.** sentence 15
 - H.** sentence 16

- 9.** Which transition phrase should be added to the beginning of sentence 18?
- A.** Although the Gotthard Base Tunnel is mainly for freight trains,
 - B.** With the Gotthard Base Tunnel taking ten years to complete,
 - C.** Because of the successful completion of the Gotthard Base Tunnel,
 - D.** As the number of trains using the Gotthard Base Tunnel increases,
- 10.** Which concluding sentence should be added after sentence 18 to support the topic presented in the passage?
- E.** There is proof that underground tunnels such as the Gotthard Base Tunnel are beneficial to the economy of the surrounding area.
 - F.** The Gotthard Base Tunnel is an extraordinary example of how human ingenuity and persistence can overcome great obstacles.
 - G.** The completion of the Gotthard Base Tunnel shows that people can work together to achieve important goals.
 - H.** The Swiss government is confident that the economic impact of the Gotthard Base Tunnel will be worth its construction cost.

READING COMPREHENSION

QUESTIONS 11–57

DIRECTIONS: Read each of the following six texts, and answer the related questions. You may write in your test booklet as needed to take notes. You should reread relevant parts of each text, while being mindful of time, before marking the **best** answer for each question. Base your answers only on the content within the text.

CONTINUE TO THE NEXT PAGE ►

Excerpt from “The World Has an E-Waste Problem”

by Alana Semuels

- 1 As a tech-hungry nation . . . gets ready to upgrade to the next generation of lightning-fast 5G devices, there is a surprising environmental cost to be reckoned with: a fresh mountain of obsolete¹ gadgets. About 6 million pounds of discarded electronics are already processed monthly at recycling giant ERI’s Fresno plant. Pallets² of once beloved but now outdated devices . . . arrive here daily. Workers with hammers hack at the bulkiest devices, while others remove dangerous components like lithium-ion batteries. The scene is like a twisted . . . movie, with doomed gadgets riding an unrelenting conveyor belt into a machine that shreds them into piles of copper, aluminum and steel.
- 2 “In our society, we always have to have the new, best product,” said Aaron Blum, the co-founder and chief operating officer of ERI, on a tour of the facility. Americans spent \$71 billion on telephone and communication equipment in 2017, nearly five times what they spent in 2010 even when adjusted for inflation, according to the Bureau of Economic Analysis. . . . When we buy something new, we get rid of what’s old. That cycle of consumption has made electronics waste the world’s fastest-growing solid-waste stream.
- 3 That stream is expected to turn into a torrent³ as the world upgrades to 5G, the next big step in wireless technology. 5G promises faster speeds and other benefits. But experts say it will also result in a dramatic increase in e-waste, as millions of smartphones, modems and other gadgets incompatible with 5G networks are made obsolete. “I don’t think people understand the magnitude of the transition,” says ERI co-founder and executive chairman John Shegerian. “This is bigger than the change of black-and-white to color, bigger than analog to digital, by many multitudes.”
- 4 . . . Less than a quarter of all U.S. electronic waste is recycled, according to a United Nations estimate. The rest is incinerated or ends up in landfills. That’s bad news, as e-waste can contain harmful materials like mercury and beryllium that pose environmental risks.
- 5 Part of the problem is regulatory. Only 19 states have laws banning electronics from the regular trash. In states without such rules, like Nevada, electronics often end up in garbage and recycling bins, said Jeremy Walters, a community-relations manager for waste collector Republic Services. Environmental concerns aside, compacting flammable lithium-ion batteries with paper recycling can be dangerous; recycling centers have reported an uptick in fires.
- 6 Even when e-waste rules exist, it’s left up to consumers to handle their old devices properly. But recycling them can be a pain. Rather than just drop a used phone in a bin outside their homes, lots of people have to take their electronics to a store, which may pay them for it but could also charge them to get rid of it. Many consumers, paralyzed by the hassle or put off by the expense,

¹**obsolete:** outdated and no longer useful

²**Pallets:** wooden platforms used to store or transport materials in a warehouse

³**torrent:** an outpouring

simply throw their devices into the trash or stash them in a drawer, hoping they'll just disappear. "We don't necessarily have the measures to make sure people aren't throwing it away," Walters said.

- 7 One solution is to make electronics last as long as they once did. At ERI's facility, Shegerian showed TIME [magazine] dozens of televisions from the 1970s and 1980s that stopped working only recently. Yet instead, technology companies are speeding the pace of obsolescence. Most smartphone batteries can't be easily replaced when they stop holding a charge, new laptops don't accept old cables, and software companies push upgrades that won't run on old devices. "Our products today don't last as long as they used to, and it's a strategy by manufacturers to force us into shorter and shorter upgrade cycles," said Kyle Wiens, the founder of iFixit, which publishes do-it-yourself repair guides. . . .
- 8 Some environmental groups say multibillion-dollar companies . . . should pick up the cost of recycling the devices they sell. Lawmakers in parts of Europe and Canada and in some U.S. states have passed so-called Extended Producer Responsibility (EPR) laws, which require manufacturers to establish and fund systems to recycle or collect obsolete products. . . .
- 9 . . . Some companies are increasing their recycling efforts on their own, whether for the economic benefit or the public relations boost.

From "The World Has an E-Waste Problem" by Alana Semuels from TIME Magazine, June 3, 2019. Copyright © 2019 TIME USA, LLC.

ENVIRONMENTAL IMPACTS OF PERSISTENT BIOACCUMULATIVE TOXIC CHEMICALS IN ELECTRONIC DEVICES

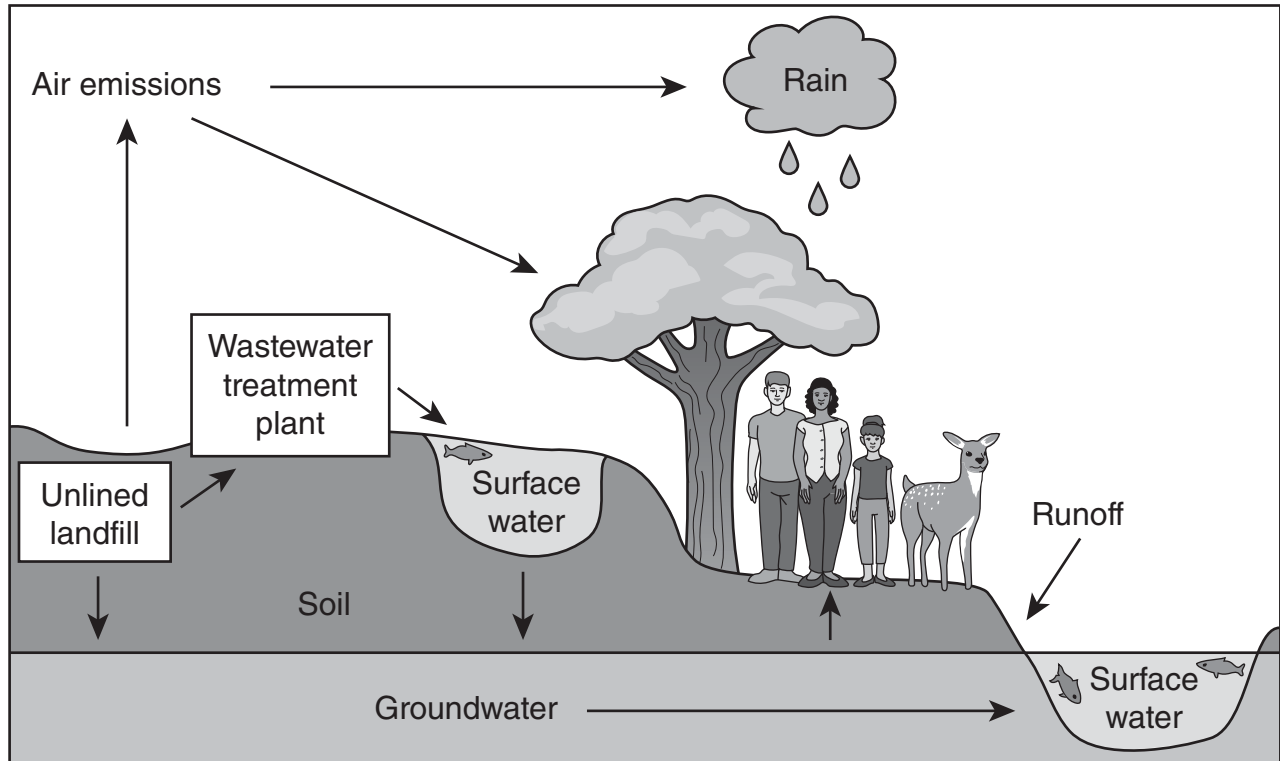

Electronics such as smartphones, computers, cameras, and large appliances contain toxins like lead, chromium, zinc, nickel, mercury, beryllium, and cadmium. These substances are bioaccumulative, which means that they accumulate over time in living organisms.

11. Read this sentence from paragraph 1.

The scene is like a twisted . . . movie, with doomed gadgets riding an unrelenting conveyor belt into a machine that shreds them into piles of copper, aluminum and steel.

The words “twisted,” “doomed,” and “unrelenting” **most** affect the sentence by

- A. emphasizing that discarded devices are condemned to an unfortunate fate.
- B. expressing a sense of desperation about the amount of waste from discarded devices.
- C. implying that discarded devices are often disposed of in an inappropriate manner.
- D. suggesting a feeling of doubt about solving the problem of discarded devices.

- 12.** How does paragraph 2 build on what the reader learns in paragraph 1?
- E.** Paragraph 2 explains the underlying cause of the massive amounts of recycling that are described in paragraph 1.
 - F.** Paragraph 2 discusses the past trends that have led to the technological innovation mentioned in paragraph 1.
 - G.** Paragraph 2 cites statistics that support the claim about technology that is stated at the beginning of paragraph 1.
 - H.** Paragraph 2 expresses disapproval of the consumers who throw away the products that are discussed in paragraph 1.
- 13.** Which sentence from the excerpt suggests that electronic devices are purposely designed to be disposed of after a short time?
- A.** “ ‘In our society, we always have to have the new, best product,’ said Aaron Blum, the co-founder and chief operating officer of ERI, on a tour of the facility.” (paragraph 2)
 - B.** “Even when e-waste rules exist, it’s left up to consumers to handle their old devices properly.” (paragraph 6)
 - C.** “Most smartphone batteries can’t be easily replaced when they stop holding a charge, new laptops don’t accept old cables, and software companies push upgrades that won’t run on old devices.” (paragraph 7)
 - D.** “Some environmental groups say multibillion-dollar companies . . . should pick up the cost of recycling the devices they sell.” (paragraph 8)
- 14.** The details in paragraphs 4–5 develop a central idea of the excerpt mainly by suggesting that
- E.** the toxic components of e-waste make waste collectors reluctant to process electronic devices.
 - F.** communities across the nation have taken different approaches to the management of e-waste.
 - G.** increased amounts of e-waste will further intensify a problem that is already inadequately addressed.
 - H.** the methods that are used for disposing of non-electronic waste are inefficient for e-waste.

- 15.** What is the role of paragraphs 7–9 in the organization of the excerpt?
- A.** They emphasize the contrast between successful and unsuccessful efforts to regulate electronic waste.
 - B.** They suggest that the electronic devices that were manufactured in the past created less pollution.
 - C.** They imply that manufacturers are willing to comply with regulations that protect the environment.
 - D.** They shift the focus from a discussion of individual behavior to a discussion of corporate responsibility.
- 16.** The idea that e-waste regulations can be ineffective is conveyed in the excerpt through
- E.** a statistic indicating that only a few states have chosen to adopt e-waste regulations.
 - F.** an observation about typical consumer behavior in response to e-waste regulations.
 - G.** an acknowledgment that electronics stores sometimes profit from e-waste regulations.
 - H.** a comment that manufacturers are making an effort to recycle even without e-waste regulations.
- 17.** How does the diagram after paragraph 9 **most** support the claim made in paragraph 4?
- A.** The diagram suggests that people send large amounts of recyclable e-waste to landfills.
 - B.** The diagram emphasizes that toxic chemicals in e-waste can easily spread from landfills.
 - C.** The diagram implies that most landfills are poorly designed to accommodate e-waste.
 - D.** The diagram shows that water sources near landfills are endangered by e-waste.

CONTINUE TO THE NEXT PAGE ►

The narrator's summer job is collecting marine specimens in Puget Sound, Washington. In this excerpt, he is looking for specimens in the mudflats before daybreak. Mudflats, or flats, are coastal landforms created when sediment and silt from tides are deposited as the tides recede.

Excerpt from *The Highest Tide*

by Jim Lynch

- 1 I rounded the oyster beds, to the far side. . . . It was low tide by then, and I saw the water hesitating at its apex, neither leaving nor returning, patiently waiting for the gravitational gears to shift. Dozens of anxious clams started squirting in unison like they did whenever vibrating grains of sand warned them predators were approaching. I stopped and waited with them, to actually see the moment when the tide started returning with its invisible buffet of plankton for the clams, oysters, mussels and other filter feeders. It was right then, ankle deep in the Sound, feet numbing, eyes relaxed, that I saw the nudibranch.¹
- 2 In all my time on the flats I'd never seen one before. I'd read about them, sure. I'd handled them at aquariums but never in the wild, and I'd never even seen a photo of one this stunning. It was just three inches long but with dozens of fluorescent, orange-tipped hornlike plumes jutting from the back of its see-through body that appeared to be lit from within.
- 3 Nudibranchs are often called the butterflies of the sea, but even that understates their dazzle. Almost everything else in the northern Pacific is dressed to blend with pale surroundings. Nudibranchs don't bother, in part because they taste so lousy they don't need camouflage to survive. But also, I decided right then, because their beauty is so startling it earns them a free pass, the same way everyday life brakes for peacocks, parade floats. . . .
- 4 The dark mudflats loomed like wet, flattened dunes stretching deep into Skookumchuck Bay in front of our house. From a distance, they looked too barren to support sea life. Up close, they still did, unless you knew where to find the hearty clams, worms and tiny creatures that flourish in mud. . . . I'm not sure why I decided to take a look. It was still an hour before sunrise, and I knew exactly what the bars² looked like in the moonlight, but for some reason, I couldn't resist.
- 5 I heard it long before I saw it. It was an exhale, a release of sorts, and I instantly wondered if a whale was stranded again. We had a young minke³ stuck out there two summers prior, and it made similar noises until the tide rose high enough for rescuers to help free it. . . . I looked for a hulking silhouette but couldn't find one. I waited, but there were no more sounds. Still, I went toward what I thought I'd heard, avoiding stepping into the mud until I had to. I knew the flats well enough to know I could get stuck just about anywhere. The general rule was you didn't venture out past the shells and gravel with an incoming tide. I sank up to my knees twice, and numbing water filled my boots.

¹**nudibranch:** type of sea slug

²**bars:** sandbars

³**minke:** species of small whale

- 6 . . . I kept stepping toward the one sound I'd heard, a growing part of me hoping I'd find nothing at all. When I stopped to rest and yank up my socks, my headlamp crossed it. My first thought? A giant octopus.
- 7 Puget Sound has some of the biggest octopi in the world. They often balloon to a hundred pounds. Even the great Jacques Cousteau⁴ himself came to study them. But when I saw the long tubular shape of its upper body and the tangle of tentacles below it, I knew it was more than an octopus. I came closer, within fifty feet, close enough to see its large cylindrical siphon⁵ quiver. I couldn't tell if it was making any sounds at that point, because it was impossible to hear anything over the blood in my ears. . . .
- 8 The creature's body came to a triangular point above narrow fins that lay flat on the mud like wings, but it was hard to be sure exactly where it all began or ended, or how long its tentacles truly were, because I was afraid to pry my eyes off its jumble of arms for more than half a second. I didn't know whether I was within reach, and its arms were as big around as my ankle and lined with suckers the size of half-dollars. If they even twitched I would have run. So, I was looking at it and not looking at it while my heart spangled my vision. I saw fragments, pieces, and tried to fuse them in my mind but couldn't be certain of the whole. I knew what it had to be, but I wouldn't allow myself to even think the two words. Then I gradually realized the dark shiny disc in the middle of the rubbery mass was too perfectly round to be mud or a reflection.
- 9 It was too late to smother my scream. Its eye was the size of a hubcap.⁶

From THE HIGHEST TIDE by Jim Lynch. Copyright © 2005 by Jim Lynch. Used by permission of Bloomsbury USA. All rights reserved.

⁴**Jacques Cousteau:** renowned French oceanographer

⁵**siphon:** tube-like organ that is used for drawing in or removing fluids

⁶**hubcap:** removable cap over the end of a wheel axle

18. In paragraph 3, the phrase “the butterflies of the sea” conveys the idea that
- E. nudibranchs do not have to work as hard as other animals to survive in the ocean.
 - F. nudibranchs have colorful features that make them stand out.
 - G. nudibranchs are delicate and have trouble adapting to their environment.
 - H. nudibranchs are rare and difficult to find in the ocean.

19. Read these sentences from paragraph 4.

I'm not sure why I decided to take a look. It was still an hour before sunrise, and I knew exactly what the bars looked like in the moonlight, but for some reason, I couldn't resist.

The sentences contribute to the overall structure of the excerpt by

- A. introducing the mysterious creature that the narrator discovers.
 - B. indicating a shift from the narrator recalling the past to the narrator reflecting on the present.
 - C. establishing a struggle with fear that the narrator must overcome.
 - D. building tension through indicating that the narrator is going to see something unexpected.
20. Which sentence from paragraph 5 supports the idea that the narrator is taking a risk?
- E. "It was an exhale, a release of sorts, and I instantly wondered if a whale was stranded again."
 - F. "I looked for a hulking silhouette but couldn't find one."
 - G. "I waited, but there were no more sounds."
 - H. "I knew the flats well enough to know I could get stuck just about anywhere."
21. Read this sentence from paragraph 6.

I kept stepping toward the one sound I'd heard, a growing part of me hoping I'd find nothing at all.

How do the narrator's actions develop a central idea of the excerpt?

- A. The narrator's concern about the origin of the noise shows dedication to helping preserve sea life in the mudflats.
- B. The narrator's curiosity about the sea life in the mudflats outweighs any fear about the situation.
- C. The narrator's knowledge about a variety of sea life encourages a search for more specimens to study.
- D. The narrator's eagerness about new specimens of sea life outweighs the reality that the area is an unlikely place to find them.

22. Read these sentences from paragraph 8.

So, I was looking at it and not looking at it while my heart spangled my vision. I saw fragments, pieces, and tried to fuse them in my mind but couldn't be certain of the whole.

The sensory language “spangled my vision,” “I saw fragments, pieces,” and “tried to fuse them in my mind” conveys the narrator’s

- E. extreme excitement about making a great discovery.
- F. reluctant acceptance that he needs to leave the mudflats.
- G. terrified confusion about the creature in the mudflats.
- H. sudden concern about his personal safety.

23. The author develops the narrator’s point of view when the narrator sees the creature by

- A. describing the narrator’s movements as he approaches the creature.
- B. emphasizing the odds of finding the creature in an area inhabited by a rival species.
- C. showing the narrator’s growing realization of the creature’s identity.
- D. comparing the size of the creature to the size of a vehicle.

24. How does the setting affect the plot of the excerpt?

- E. The darkness of the mudflats before sunrise causes the narrator to pay close attention to his surroundings.
- F. The rugged terrain of the mudflats makes it more difficult for the narrator to do his job.
- G. The slow return of the tide along the mudflats forces the narrator to be patient during his journey.
- H. The barren appearance of the mudflats creates a sense of mystery that unsettles the narrator.

Going Solar in China

- 1 In the Anhui province of China, 166,000 floating solar panels are strung together atop the rippling surface of a lake. It is the largest solar-power farm in the world, an immense blanket of renewable energy strong enough to power 15,000 homes.
- 2 The floating solar-power farm, which harvests the sun's rays for power, was first conceived by the Sungrow Power Supply Company after heavy rains flooded a collapsed coal mine and created a lake. Sang Dajie, a former coal miner from the area, is now an electrician for the farm, which occupies the original mine site where he used to work. Now, instead of working under the dangerous conditions at the mine, he spends his days maintaining the solar panels on the water. "The coal mine," says Dajie, "was very hot and the air was bad. . . . But here I feel safe. The new energy is safe." People in China rely primarily on the burning of coal in massive power plants to create electricity. While the burning of fossil fuels, like coal, is a reliable source of energy, the process releases massive amounts of carbon dioxide into the atmosphere, creating air pollution and harming Earth. Solar power, on the other hand, is clean and safe for the environment.
- 3 Solar panels are typically placed on rooftops or in open fields, but experts in China determined that the newly formed lake was a great spot for the solar-power farm. Solar-power farms over water are efficient because the water keeps the panels cool. A water-based solar-power farm can potentially generate more power than one based on land. Additionally, with the solar-power farm on the lake, the land in the surrounding area remains available for farming, which is another source of income for Anhui residents.
- 4 Originally, China displayed minimal interest in solar energy. The use of solar energy was limited primarily to rural areas that had no access to a power grid. Without access to other means of electricity, people in these areas used solar panels as an alternative to lighting candles and kerosene lamps. China began to manufacture solar panels for other countries in the late 1990s when the German government offered its people financial incentives for installing solar panels. The heightened demand for solar panels was instantaneous, and Chinese businesses were quick to seize the opportunity. Soon the governments of Spain and Italy also offered incentives for using solar technology, and Chinese manufacturers were ready for the increased demand.
- 5 Between 2008 and 2013, China improved its manufacturing technology and processes so much that it effectively lowered the worldwide cost of using solar energy by 80 percent, further increasing demand. However, a point came when Chinese manufacturers had become so efficient at producing solar-power equipment that they outpaced the demand. The manufacturers were producing two solar panels for every one solar panel they sold. In order to make manufacturing a profitable industry again, the Chinese government offered its own financial incentives to Chinese citizens for using solar energy. Now, projects like the floating solar-power farm are putting those surplus panels to use, in addition to providing jobs and cleaner energy.
- 6 A second solar-power farm has already been constructed near the massive one in Anhui as part of a government initiative to build more low-emission power plants. The goal is to meet 20 percent of the country's energy needs with renewable, clean energy sources by the year 2030.
- 7 As Sang Dajie puts it, "I'm glad we are reusing this area to create a better future." China's dedication to increasing its production of renewable energy through solar power demonstrates that patience, time, and flexibility can result in transformation.

- 25.** The phrases “166,000 floating solar panels are strung together atop the rippling surface of a lake” and “an immense blanket of renewable energy” in paragraph 1 convey that the solar-power farm
- A.** produces the maximum amount of energy possible for its size.
 - B.** meets and exceeds the energy needs of the area.
 - C.** blends in with the surrounding landscape.
 - D.** produces a large amount of energy and is in an unusual location.
- 26.** The author includes the statements from Dajie in paragraphs 2 and 7 **most likely** to
- E.** prove that the solar-energy industry benefits the economy of China by providing jobs.
 - F.** provide the reasons why traditional energy sources are being replaced with solar-power farms.
 - G.** highlight how replacing fossil fuels with solar energy offers more than just financial benefits.
 - H.** argue that additional solar-power farms should be built in the Anhui province.
- 27.** How does paragraph 2 contribute to the development of ideas in the article?
- A.** It explains the series of events that led a former coal miner to become an electrician at a solar-power farm.
 - B.** It provides details on how a shift from coal mining to collecting solar power can improve conditions for energy workers and the environment.
 - C.** It describes the reasons a company chose to transform a lake created by a collapsed coal mine into a solar-power farm that floats on the water.
 - D.** It presents an overview of how a collapsed coal mine became a productive floating solar-power farm over several years.

- 28.** Which statement **best** describes how the chronological structure of paragraphs 4–5 contributes to the development of ideas in the article?
- E.** It reveals how China’s businesses lowered the cost of solar energy over time for other countries.
 - F.** It depicts how China’s government helped the Chinese solar-energy industry respond to growth in the international demand for solar energy.
 - G.** It reveals how China’s position on using solar energy changed because of a surplus supply of solar panels.
 - H.** It depicts how China’s solar-energy industry improved the manufacturing of solar panels in order to increase revenue.
- 29.** How do the details in paragraph 6 about the solar-power goals of the Chinese government convey a central idea of the article?
- A.** They indicate that the Chinese government wants China to be the world leader in solar-energy production.
 - B.** They show that the Chinese government understands the benefits of transitioning to renewable energy sources such as solar power.
 - C.** They suggest that constructing solar-power farms is the best way for the Chinese government to put excess solar panels to use.
 - D.** They imply that solar farms are a good way for the Chinese government to make solar power the main source of energy in China.
- 30.** China’s role in the increase of solar-energy use around the world is illustrated in the article mainly through the inclusion of
- E.** information about where Chinese businesses sold solar panels and other materials for solar-power farms.
 - F.** explanations of how solar-power use in China demonstrated that solar power could replace other energy sources.
 - G.** details about how the Chinese government encouraged its citizens to use solar energy.
 - H.** facts indicating that Chinese manufacturing processes helped make solar power more affordable.

- 31.** The author’s purpose for writing the article is **best** conveyed by the
- A.** information about the positive outcomes China has achieved by producing renewable energy.
 - B.** facts about how China has influenced other countries to use solar power as a source of renewable energy.
 - C.** statements that present solar power as one of several forms of energy used throughout China.
 - D.** details that emphasize how China developed its solar-power industry primarily as a means of financial gain.
- 32.** How do the details in paragraph 4 about Germany, Spain, and Italy contribute to a central idea of the article?
- E.** They indicate why businesses in China worked to become proficient producers of solar panels.
 - F.** They emphasize the global need for solar power as a source of renewable energy.
 - G.** They reveal that European countries were competing to see which country could reach its renewable-energy goals first.
 - H.** They suggest that other countries viewed China as a model for constructing solar-power farms in unlikely places.

Excerpt from “How Exercise Could Help You Learn a New Language”

by Gretchen Reynolds

- 1 Many scientists suspect that exercise alters the biology of the brain in ways that make it more malleable and receptive to new information, a process that scientists refer to as plasticity.
- 2 But many questions have remained unanswered about movement and learning, including whether exercise is most beneficial before, during or after instruction and how much and what types of exercise might be best.
- 3 So for a new study, which was published recently in *PLOS One*, researchers in China and Italy decided to home in on language learning and the adult brain.
- 4 Language learning is interesting. As young children, almost all of us picked up our first language easily. We didn’t have to be formally taught; we simply absorbed words and concepts.
- 5 But by early adulthood, the brain generally begins to lose some of its innate language capability. It displays less plasticity in areas of the brain related to language. As a result, for most of us, it becomes harder to learn a second language after childhood.
- 6 To see what effects exercise might have on this process, the researchers first recruited 40 college-age Chinese men and women who were trying to learn English. The students had some facility with this second language but were far from proficient.
- 7 The researchers then divided the students into two groups. Those in one group would continue to learn English as they had before, primarily while seated in rote vocabulary-memorization sessions.
- 8 The others would supplement these sessions with exercise.
- 9 Specifically, the students would ride exercise bikes at a gentle pace (about 60 percent of their maximum aerobic capacity) beginning 20 minutes before the start of the lessons and continuing throughout the 15 minutes or so of instruction.
- 10 Both groups learned their new vocabulary by watching words projected onto large screens, together with comparable pictures, such as “apple” and a Red Delicious. They were shown 40 words per session, with the sequence repeated several times.
- 11 Afterward, the students all rested briefly and then completed a vocabulary quiz, using computer keys to note as quickly as possible whether a word was with its correct picture. They also responded to sentences using the new words, marking whether the sentences were accurate or, in the case of “The apple is a dentist,” nonsensical. Most linguists¹ feel that understanding sentences shows greater mastery of a new language than does simple vocabulary improvement.
- 12 The students completed eight vocabulary sessions over the course of two months.

¹**linguists:** scientists who study language

- 13 And at the end of each lesson, the students who had ridden bikes performed better on the subsequent vocabulary tests than did the students who sat still.
- 14 They also became more proficient at recognizing proper sentences than the sedentary students, although that difference did not emerge until after several weeks of instruction.
- 15 Perhaps most interesting, the gains in vocabulary and comprehension lingered longest for the cyclists. When the researchers asked the students to return to the lab for a final round of testing a month after the lessons—without practicing in the meantime—the cyclists remembered words and understood them in sentences more accurately than did the students who had not moved.
- 16 “The results suggest that physical activity during learning improves that learning,” says Simone Sulpizio, a professor of psychology and linguistics at the University Vita-Salute San Raffaele in Milan, Italy, and a study co-author.
- 17 These improvements extend beyond simply aiding in memorization, she added. The exercise also deepened language learners’ grasp of how to use their newly acquired words.
- 18 This study involved college students performing relatively light exercise, though, and cannot tell us whether other people completing other types of exercise would achieve the same results.
- 19 It also offers no clues about what is occurring inside the brain that might be contributing to the benefits of the exercise. But many past studies have shown that exercise prompts the release of multiple neurochemicals in the brain that increase the number of new brain cells and the connections between neurons, Dr. Sulpizio says. These effects improve the brain’s plasticity and augment the ability to learn.
- 20 From a real-world standpoint, the study’s implications might seem at first to be impractical. Few classrooms are equipped with stationary bicycles. But specialized equipment is probably unnecessary, Dr. Sulpizio says.
- 21 “We are not suggesting that schools or teachers buy lots of bicycles,” she says. “A simpler take-home message may be that instruction should be flanked by physical activity.”

From “How Exercise Could Help You Learn a New Language” by Gretchen Reynolds from THE NEW YORK TIMES, August 16, 2017. Copyright © 2017 The New York Times Company.

33. How does the author’s use of comparison in paragraphs 4 and 5 contribute to the development of ideas in the excerpt?
- A. It identifies why many adults are never able to learn a second language.
 - B. It demonstrates why the study of adult language learning tries to include physical activity.
 - C. It highlights why more is known about language learning in children than about language learning in adults.
 - D. It explains why adults were the subjects of the study rather than children.

34. Read this sentence from paragraph 6.

To see what effects exercise might have on this process, the researchers first recruited 40 college-age Chinese men and women who were trying to learn English.

Which statement describes the function of the sentence in the overall structure of the excerpt?

- E. It indicates a shift from describing the results of the study to describing the process.
 - F. It introduces the aspect of the research that was most critical to determining the results.
 - G. It marks the change from explaining why the study was conducted to explaining how the study was conducted.
 - H. It shows how questions were raised that could be addressed in further research.
35. In the study described in the excerpt, researchers asked English learners to assess the sense of words in context because that task is
- A. better at determining the capability learners have of language than simple vocabulary recall.
 - B. consistent with the way earlier research was conducted on adult language learners.
 - C. a better way for learners to absorb the meaning of individual vocabulary words.
 - D. more difficult for learners to perform after an extended period of time has passed.

36. Which evidence from the excerpt is **most** relevant to the author’s claim that there are many unanswered questions about the relationship between movement and learning?

- E. the method of the study using one type of exercise and people from one age group
- F. the statement from Dr. Sulpizio explaining past studies on neurochemicals in the brain
- G. the finding of the study that exercise helps people recall information over a long period of time
- H. the statement from Dr. Sulpizio describing how the results of the study can be applied

37. Read these sentences from paragraph 17.

These improvements extend beyond simply aiding in memorization, she added. The exercise also deepened language learners’ grasp of how to use their newly acquired words.

Which sentence from the excerpt **best** explains why Dr. Sulpizio feels confident in the conclusion stated in these sentences?

- A. “They were shown 40 words per session, with the sequence repeated several times.” (paragraph 10)
- B. “They also responded to sentences using the new words, marking whether the sentences were accurate or, in the case of ‘The apple is a dentist,’ nonsensical.” (paragraph 11)
- C. “And at the end of each lesson, the students who had ridden bikes performed better on the subsequent vocabulary tests than did the students who sat still.” (paragraph 13)
- D. “They also became more proficient at recognizing proper sentences than the sedentary students, although that difference did not emerge until after several weeks of instruction.” (paragraph 14)

38. Paragraph 18 shows that the author’s perspective toward the study described in the excerpt is that
- E. though the study allowed some conclusions to be drawn, these conclusions are limited.
 - F. while the study focused on moderate exercise, it would have been better to focus on difficult exercise.
 - G. while the study was performed appropriately, it is doubtful the results can be duplicated.
 - H. though the study was about learning language, its conclusions can be applied to learning in general.
39. Which sentence is the **best** summary of the research procedure used in the study in the excerpt?
- A. Researchers had a group of non-English-speaking students learn new English vocabulary by matching words and images on a computer screen, and also by analyzing words in context; some students exercised and some students sat still while learning.
 - B. Researchers first divided non-English-speaking students into two groups with one group exercising before and while studying English and the other group studying English without exercising; then, after instruction, student learning was assessed.
 - C. Researchers first had non-English-speaking students sit on stationary bikes and pedal for 20 minutes before instruction and 15 minutes during instruction; then, after a rest period, students indicated whether English sentences made sense.
 - D. Researchers asked non-English-speaking students to study English while sitting or biking; then the students’ vocabulary skills were assessed after a short break period and also after a break of a full month without their having studied any of the materials.

CONTINUE TO THE NEXT PAGE ►

Located underground near Geneva, Switzerland, the Large Hadron Collider (LHC) helps scientists study and understand how the smallest particles of matter interact with one another. The LHC propels atomic particle beams along a 17-mile-long ring.

Looking for the Smallest Spark of Everything

There are the things the world is made of,
things we can see and feel, and then
there are the things even smaller, things that seem
to exist only when we are looking right at them.

5 So beneath the level of molecules are atoms,
and beneath the level of atoms, we find
protons, electrons, neutrons; and beneath that—
what, exactly? Because we are talking about
everything here: your fingernail,
10 the candy at the back of your mouth,
the coffee your teacher drank this morning,
your little sister, and the stuffed dog
she used to carry around with her everywhere.
And everywhere.

15 Everything and everywhere
are made up of the same stuff, whatever
it is. How do we find it? We can listen for it
in the wavelengths from deep space,
talking back to us from unimaginable
20 distances. Or we can build long,
deep circular tunnels beneath the surface
of this Earth and race particles
(like racing cars, only very tiny cars
flashing along at close to the speed of light)
25 until everything we think we know
bangs against everything else we know.

And there, in the explosion, in the darkness,
briefly incandescent, they appear:
the quarks, the leptons, and the bosons;
30 the baryons and the mesons. Their names
sound like dinosaurs or maybe bands
playing terrible music in someone's garage.

The one thing we know for sure
is that they spin. This is how gravity
35 enters our world, how our world is held
both together and apart, what keeps
together the pencil in your hand right now

as well as separate from, say,
Jupiter. They spin, and it is only down there
40 in the darkness—in the vast garage
where physicists jot down
what they can, whatever seems most real—
that they let us perceive their wild dancing,
combusting to the music they make.

40. Read lines 5–8 from the poem.

**So beneath the level of molecules are atoms,
and beneath the level of atoms, we find
protons, electrons, neutrons; and beneath that—
what, exactly?**

The lines help develop a central idea of the poem by revealing the speaker's

- E. interest in determining how the parts of matter work together.
 - F. curiosity about what makes up matter.
 - G. desire to prove that particles make up matter.
 - H. questions about what tools are needed to study matter.
41. The break between the second stanza (lines 5–14) and the third stanza (lines 15–26) serves as a transition from
- A. identifying common physical objects to explaining how the particles that make up all physical things are observed.
 - B. suggesting that the visible world is made up of simple materials to revealing why invisible materials make the world complicated.
 - C. discussing the methods used to study particles in space to describing how matter is researched on Earth.
 - D. describing an environment that feels comfortable to characterizing an environment that seems unstable.

42. The main purpose of the comparison in lines 23–24 of the poem is to show
- E. that the particles' size makes them difficult to see.
 - F. how the particles move within the tunnel.
 - G. that the particles have a familiar shape.
 - H. how the particles can be seen only in darkness.

43. Read lines 25–26 from the poem.

**until everything we think we know
bangs against everything else we know.**

The lines help develop a central idea in the poem by suggesting that

- A. creative methods for researching particles are frequently being invented.
 - B. ongoing research continues to add to our knowledge of particles.
 - C. our understanding of particles is limited by the equipment available to study them.
 - D. competing theories about particles provoke scientific debate.
44. Read lines 27–28 from the poem.

**And there, in the explosion, in the darkness,
briefly incandescent, they appear:**

The imagery in the lines reveals that the speaker

- E. envies the physicists who research colliding particles.
- F. has personally observed colliding particles.
- G. admires the powerful reactions that occur when particles collide.
- H. has a simplistic understanding of how particles collide.

45. Read lines 30–32 from the poem.

**Their names
sound like dinosaurs or maybe bands
playing terrible music in someone’s garage.**

The speaker refers to familiar objects and events in the lines **most likely** to

- A. explain confusing information in simple terms to help the reader understand more about the topic.
 - B. demonstrate how scientific ideas can be explained by describing situations that many people are familiar with.
 - C. emphasize that the process being used to research particles is still in the early stages of development.
 - D. suggest that the scientific language used to describe particles seems silly by making a humorous comparison.
46. Read lines 36–39 from the poem.

**both together and apart, what keeps
together the pencil in your hand right now
as well as separate from, say,
Jupiter.**

The poet includes these lines **most likely** to emphasize that

- E. it is important for physicists to continue their research about particles.
- F. these particles have a powerful effect on everything.
- G. the discoveries about particles provide little information.
- H. the study of particles and the study of objects in space are similar.

47. The last stanza (lines 33–44) concludes the poem by emphasizing which central idea?
- A. The exciting work that physicists conduct provides information about fundamental aspects of the universe.
 - B. The unusual work of physicists is carried out in unconventional locations and in special conditions.
 - C. Physicists are learning about the unpredictable behavior of particles that break up matter in the universe.
 - D. Physicists enthusiastically share the discoveries their research yields because most people can relate to their findings.

48. Read lines 39–44 from the poem.

**They spin, and it is only down there
in the darkness—in the vast garage
where physicists jot down
what they can, whatever seems most real—
that they let us perceive their wild dancing,
combusting to the music they make.**

The lines reveal the speaker's

- E. frustration with the research facilities physicists use.
- F. belief that physicists are frantically working toward a new discovery.
- G. interest in physicists and their study of particles.
- H. certainty that physicists are working in secrecy.

CONTINUE TO THE NEXT PAGE ►

Zitkala-Sa (Gertrude Simmons Bonnin) was a Native American writer, musician, teacher, and political activist who was raised on the Yankton Sioux Reservation in South Dakota. In 1900 she published "Impressions of an Indian Childhood" (the term Indian was commonly used at the time to refer to Native American people) to expose readers to what life is like on a reservation.

Excerpt from "Impressions of an Indian Childhood"

by Zitkala-Sa

- 1 Soon after breakfast Mother sometimes began her beadwork. On a bright, clear day, she pulled out the wooden pegs that pinned the skirt of our wigwam¹ to the ground, and rolled the canvas part way up on its frame of slender poles. Then the cool morning breezes swept freely through our dwelling, now and then wafting the perfume of sweet grasses from newly burnt prairie.
- 2 Untying the long tasseled strings that bound a small brown buckskin² bag, my mother spread upon a mat beside her bunches of colored beads, just as an artist arranges the paints upon his palette. On a lapboard she smoothed out a double sheet of soft white buckskin; and drawing from a beaded case that hung on the left of her wide belt a long, narrow blade, she trimmed the buckskin into shape. Often she worked upon small moccasins for her small daughter. Then I became intensely interested in her designing. With a proud, beaming face, I watched her work. In [my] imagination, I saw myself walking in a new pair of snugly fitting moccasins. I felt the envious eyes of my playmates upon the pretty red beads decorating my feet.
- 3 Close beside my mother I sat on a rug, with a scrap of buckskin in one hand and an awl in the other. This was the beginning of my practical observation lessons in the art of beadwork. From a skein³ of finely twisted threads of silvery sinews my mother pulled out a single one. With an awl she pierced the buckskin, and skillfully threaded it with the white sinew. Picking up the tiny beads one by one, she strung them with the point of her thread, always twisting it carefully after every stitch.
- 4 It took many trials before I learned how to knot my sinew thread on the point of my finger, as I saw her do. Then the next difficulty was in keeping my thread stiffly twisted, so that I could easily string my beads upon it. My mother required of me original designs for my lessons in beading. At first I frequently ensnared many a sunny hour into working a long design. Soon I learned from self-inflicted punishment to refrain from drawing complex patterns, for I had to finish whatever I began.
- 5 After some experience I usually drew easy and simple crosses and squares. These were some of the set forms. My original designs were not always symmetrical nor sufficiently characteristic, two faults with which my mother had little patience. The quietness of her oversight made me feel strongly responsible and dependent upon my own judgment. She treated me as a dignified little individual as long as I was on my good behavior; and how humiliated I was when some boldness of mine drew forth a rebuke from her!

¹**wigwam:** hut with an arched framework of poles covered with bark, mats, or animal hides

²**buckskin:** leather made from the skin of a male deer

³**skein:** coiled length of yarn or other thread loosely wound on a reel

6 In the choice of colors she left me to my own taste. I was pleased with an outline of yellow upon a background of dark blue, or a combination of red and myrtle-green. There was another of red with a bluish-gray that was more conventionally used. When I became a little familiar with designing and the various pleasing combinations of color, a harder lesson was given me. It was the sewing on, instead of beads, some tinted porcupine quills, moistened and flattened between the nails of the thumb and forefinger. My mother cut off the prickly ends and burned them at once in the centre fire. These sharp points were poisonous, and worked into the flesh wherever they lodged. For this reason, my mother said, I should not do much alone in quills until I was as tall as my cousin Warca-Ziwin.

7 Always after these confining lessons I was wild with surplus spirits, and found joyous relief in running loose in the open again. Many a summer afternoon a party of four or five of my playmates roamed over the hills with me. We each carried a light sharpened rod about four feet long, with which we pried up certain sweet roots. When we had eaten all the choice roots we chanced upon, we shouldered our rods and strayed off into patches of a stalky plant under whose yellow blossoms we found little crystal drops of gum. Drop by drop we gathered this nature's rock-candy, until each of us could boast of a lump the size of a small bird's egg. Soon satiated with its woody flavor, we tossed away our gum, to return again to the sweet roots.

A BRIEF HISTORY OF BEADWORK IN SOUTH DAKOTA

Date	Event
1500s	The Dakota use beads made from bones, shells, stones, and animal teeth. European traders bring glass beads to North America.
Late 1600s	The Dakota begin trading with the French in Minnesota.
1830s	The Dakota begin using glass beads in clothing, artwork, and decorations in place of Native-made beads.
1862–1865	The Dakota are expelled from their homelands in Minnesota as a result of the U.S.-Dakota War.
1900s–1920s	The Dakota create items to sell outside their community.

Source: MNopedia

From "Impressions of an Indian Childhood" by Zitkala-Sa—Public Domain

- 49.** In paragraph 1, the phrases “cool morning breezes swept freely” and “wafting the perfume of sweet grasses” affect the tone of the excerpt by suggesting
- A.** the sadness that the author feels reflecting upon her former way of life.
 - B.** the enthusiasm with which the author approached her work indoors.
 - C.** the fond feelings that the author has toward her childhood experiences.
 - D.** the mix of emotions that the author feels toward her work and her mother.
- 50.** The phrase “just as an artist arranges the paints upon his palette” in paragraph 2 suggests that
- E.** beadwork is a true form of art.
 - F.** color is a source of artistic inspiration.
 - G.** all artistic activities begin with a series of steps.
 - H.** the beadworker tries to imitate art.
- 51.** The author’s use of sequence in paragraphs 1 and 2 contributes to the development of ideas in the excerpt by
- A.** listing the many steps that are involved in the process of beading in order to explain its difficulty and complexity.
 - B.** conveying the importance of following the steps of the beading process in a precise order to work most efficiently.
 - C.** emphasizing the time required to fully prepare for and execute the many large and small tasks in the activity of beading.
 - D.** detailing each step in preparation for beading in order to highlight the author’s enthusiasm for the work.
- 52.** The details in paragraph 3 convey a central idea of the excerpt by suggesting that
- E.** the author was interested in the work because she knew her mother was making something for her.
 - F.** the author had difficulty learning through observation but wanted to help her mother.
 - G.** the author was determined to behave according to her mother’s standards and sought her approval.
 - H.** the author had great admiration for her mother’s precision and mastery of her craft.

- 53.** Which sentence **best** summarizes the process of beading that is described in the excerpt?
- A.** Take a buckskin bag full of beads and spread them out on a mat in different colors like a paint palette; take a double sheet of buckskin and smooth it out on a table; take a sinew and awl and thread the beads onto the buckskin in a desired pattern.
 - B.** Cut the double sheet of buckskin into a shape; take a skein of sinew and pierce the buckskin with an awl; thread the sinew with beads of many different colors in a simple or complex pattern; twist the sinew to keep it tight after every stitch into the buckskin.
 - C.** Arrange the beads into groups of colors on a mat; smooth out a double sheet of buckskin and cut it to shape; take a single thread of sinew; pierce the buckskin with an awl; thread the buckskin with the sinew and string it with beads, carefully twisting after every stitch.
 - D.** Gather beads, buckskin, sinew, and awl and place them on a mat; cut the buckskin into the desired shape; decide on a pattern for the beads and create it using the sinews and the awl; thread the beads onto the sinew in the desired pattern and twist it tight.
- 54.** The idea that mastering moccasin design and creation requires experience is **best** illustrated in the excerpt through
- E.** the information about the advanced technique of incorporating porcupine quills into a design.
 - F.** the descriptions of the special materials that must be used to make decorated moccasins.
 - G.** the descriptions of the various color combinations that make an attractive moccasin design.
 - H.** the example of the author successfully and independently using a sharpened rod.
- 55.** How does the author distinguish her point of view from that of her mother?
- A.** by describing their techniques for knotting sinew thread (paragraph 4)
 - B.** by describing their approaches to beadwork design (paragraph 5)
 - C.** by stating her mother’s instructions on working with quills (paragraph 6)
 - D.** by stating her mother’s ideas about activities after lessons (paragraph 7)

56. Read this sentence from paragraph 7.

Always after these confining lessons I was wild with surplus spirits, and found joyous relief in running loose in the open again.

Which sentence **best** describes how this sentence fits into the overall structure of the excerpt?

- E. It introduces a shift from the author’s demanding relationship with her mother to her more relaxed relationships with friends.
 - F. It signals a change from the challenging aspects of life on the reservation to the advantages of living on the prairie.
 - G. It highlights a contrast between the focus and control required while working and the freedom of having fun outside.
 - H. It concludes the progression of events in the narrative by describing the sequence of events at the end of the author’s day.
57. The table after paragraph 7 expands upon a central idea in the excerpt because it shows that
- A. the craft that the author was learning was a tradition that endured through many generations and changes.
 - B. the author’s family incorporated traditional materials into their craft as a way of resisting the influence from European traders.
 - C. the uniqueness of the cultural tradition that the author learned as a child was eventually recognized in Europe.
 - D. the author was able to incorporate color into her craftwork as a result of trade with other peoples.

CONTINUE TO THE NEXT PAGE ►

PART 2 — MATHEMATICS

57 QUESTIONS

IMPORTANT NOTES

- (1) Formulas and definitions of mathematical terms and symbols are **not** provided.
- (2) Diagrams other than graphs are **not** necessarily drawn to scale. Do not assume any relationship in a diagram unless it is specifically stated or can be determined from the information given.
- (3) Assume that a diagram is in one plane unless the question specifically states that it is not.
- (4) Graphs are drawn to scale. Unless stated otherwise, you can assume relationships according to appearance. For example, lines on a graph that appear to be parallel can be assumed to be parallel. This is also true for concurrent lines, straight lines, collinear points, right angles, etc.
- (5) Reduce (simplify) all fractions to lowest terms.

GRID-IN QUESTION NOTES

- (1) For each grid-in question, write your answer at the top of the grid.
- (2) Begin recording your answer in the columns on the far left.
- (3) Fill in the circle under the box that matches the number or symbol you wrote. Leave the negative sign bubble blank if your answer is positive.

(Answer: -1.5)

	-	1	.	5	
Negative sign →	<input checked="" type="radio"/>	<input type="radio"/>	<input checked="" type="radio"/>	<input type="radio"/>	← Decimal point
	0	0	0	0	
	<input checked="" type="radio"/>	1	1	1	
	2	2	2	2	
	3	3	3	3	
	4	4	4	4	
	5	5	<input checked="" type="radio"/>	5	
	6	6	6	6	
	7	7	7	7	
	8	8	8	8	
	9	9	9	9	

(Answer: 3.2)

	3	.	2		
Negative sign →	<input type="radio"/>	<input type="radio"/>	<input checked="" type="radio"/>	<input type="radio"/>	← Decimal point
	0	0	0	0	
	1	1	1	1	
	2	2	<input checked="" type="radio"/>	2	
	<input checked="" type="radio"/>	3	3	3	
	4	4	4	4	
	5	5	5	5	
	6	6	6	6	
	7	7	7	7	
	8	8	8	8	
	9	9	9	9	

CONTINUE TO THE NEXT PAGE ►

GRID-IN QUESTIONS

QUESTIONS 58–62

DIRECTIONS: Solve each problem. On the answer sheet, write your answer in the boxes at the top of the grid. Start on the left side of each grid. Print only one number or symbol in each box. Under each box, fill in the circle that matches the number or symbol you wrote above.

- Do not fill in a circle under an unused box.
- Do not leave a box blank in the middle of an answer.

58.

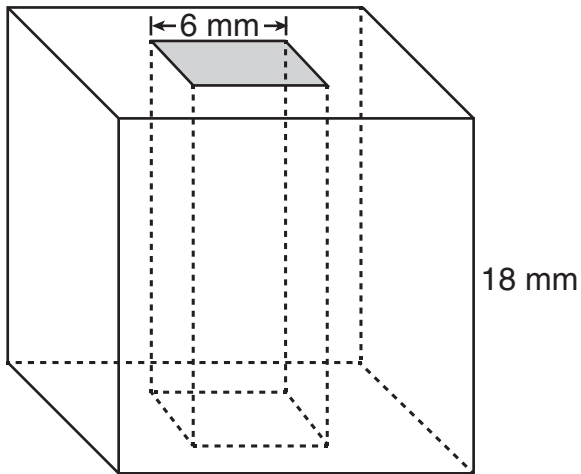

Beth makes a bead in the shape of a cube with side length 18 millimeters. She cuts a hole in the shape of a square prism out of the center of the cube so that the bead will fit on a string. The base of the square prism has a side length of 6 millimeters. After the hole is cut out, what is the volume of the bead in cubic millimeters?

59. The table shows the proportional relationship between x cups of oatmeal and y ounces of raisins in a bread recipe.

BREAD RECIPE

Cups of Oatmeal (x)	Ounces of Raisins (y)
2	1.0
3	1.5
6	3.0

What is the constant of proportionality of the number of ounces of raisins to the number of cups of oatmeal?

60. Kelly had 7.3 grams of sugar. She used 2.7 grams in her coffee. How many grams of sugar does she have left?

61. The total cost of a book is given by the expression $1.08x$, where x is the price of the book before tax. The tax rate is $m\%$. What is the value of m ?

62. A row of seats in a theater contains 20 seats numbered from 101 to 120. The probability that a randomly chosen seat in this row will be numbered 104 is $x\%$. What is the value of x ?

MULTIPLE CHOICE QUESTIONS

QUESTIONS 63–114

DIRECTIONS: Solve each problem. Select the answer from the choices given. Mark the letter of your answer on the answer sheet. When you are solving problems, you can write in the test booklet or on the scrap paper given to you.

63. What is the prime factorization of 3,575?

- A. $5 \cdot 11 \cdot 13$
- B. $5^2 \cdot 11 \cdot 13$
- C. $5 \cdot 715$
- D. $5^2 \cdot 143$

64. If $\frac{x + 2y}{5} = 3y$, what is the value of x in terms of y ?

- E. $\frac{7y}{5}$
- F. $\frac{13y}{5}$
- G. 13
- H. $13y$

65. What is the value of z in

$$\frac{x}{10} + \frac{y - x}{5} = \frac{z}{10}?$$

- A. 1
- B. 5
- C. y
- D. $2y - x$

66. Two sets, R and S , are described below. The sum of the elements in set R equals the sum of the elements in set S .

$$R = \{5, x, 3, 8\}$$
$$S = \{6, y, 4, 1\}$$

What is the value of $x - y$?

- E. -7
- F. -5
- G. 5
- H. 7

67. If $x = \frac{1}{4}$, what is the value of $\frac{2}{2-x}$?

A. $\frac{3}{4}$

B. $\frac{8}{9}$

C. $1\frac{1}{7}$

D. $3\frac{1}{2}$

68. The cost of shipping a package is \$12, plus \$2 for each additional pound over 3 pounds. Which expression represents the total cost, in dollars, of shipping a package that weighs p pounds? Assume that $p \geq 3$.

E. $12 + 2(p + 3)$

F. $12 + 2(p - 3)$

G. $14p + 3$

H. $14p - 3$

69. Julie is at a clothing store. She wants to buy a bag for \$18.75 and some T-shirts for \$9.25 each. She can spend no more than \$50.00. Which inequality can be used to find the number of T-shirts, x , Julie can purchase?

A. $9.25 + 18.75x \leq 50.00$

B. $9.25 + 18.75x \geq 50.00$

C. $18.75 + 9.25x \leq 50.00$

D. $18.75 + 9.25x \geq 50.00$

70. $2x + 11 > 3x + 9$

For what values of x is the above inequality true?

E. $x < 2$

F. $x > 2$

G. $x < 20$

H. $x > 20$

71. In a scale drawing of a triangular park, the sides measure 5 inches, 7 inches, and 8 inches. The perimeter of the actual park is 25 miles. What is the actual length of the shortest side of the park?

- A. 6.25 mi
- B. 8.75 mi
- C. 10 mi
- D. 15.625 mi

72.

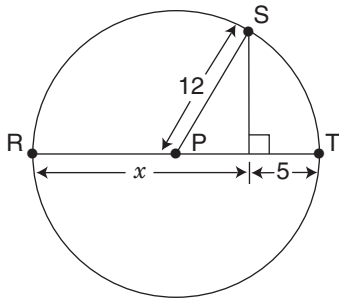

P is the center of the circle above, and R, S, and T are points on the circle. What is the value of x ?

- E. 12
- F. 15
- G. 17
- H. 19

73.

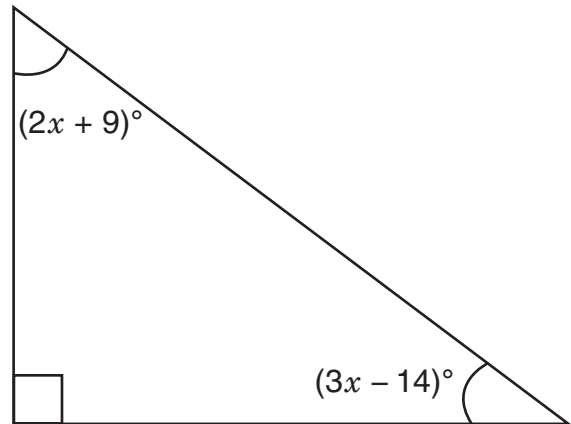

In the right triangle shown above, what is the measure of the smallest angle?

- A. 43°
- B. 44°
- C. 46°
- D. 47°

74. James must read 84 pages of a book for a class assignment. If he reads $\frac{1}{4}$ of the pages in the morning and $\frac{1}{3}$ of the **remaining** pages in the afternoon, how many pages will he still need to read?

- E. 35
- F. 42
- G. 45
- H. 56

75. $\frac{1}{11} + \frac{1}{22} + \frac{1}{33}$
- What is the value of the expression shown above?

- A. $\frac{1}{22}$
- B. $\frac{1}{11}$
- C. $\frac{1}{6}$
- D. $\frac{3}{22}$

76. At Midville High School, 64 students are members of either the orchestra or the choir, or both. Of these students, 38 are members of the orchestra, and 46 are members of the choir. What fraction of the total is the number of students who are members of **both** the orchestra and the choir?

- E. $\frac{16}{21}$
- F. $\frac{10}{19}$
- G. $\frac{10}{23}$
- H. $\frac{5}{16}$

77. Which of the following decimals is equivalent to $1\frac{2}{3} + 2\frac{4}{9}$?

- A. $3.\overline{1}$
- B. $3.\overline{6}$
- C. $4.\overline{1}$
- D. $4.\overline{9}$

78. The decimal 0.4 can be written as the fraction $\frac{x}{25}$. What is the value of x ?

- E. 0.016
- F. 0.16
- G. 10
- H. 16

79. What is the value of $\frac{-9(-4)^2 + 36(-4) + 304}{-4}$?

- A. -76
- B. -4
- C. 4
- D. 148

80. Maxie borrowed \$7.75 from her mother, \$11.00 from her father, and \$4.50 from her brother to purchase a video game. Her grandmother gave her \$25.00 as a gift. How much money will Maxie have left or still owe if she uses the money her grandmother gave her to pay back the money she borrowed?

- E.** Maxie will still owe \$2.25.
- F.** Maxie will still owe \$1.75.
- G.** Maxie will have \$1.75 left.
- H.** Maxie will have \$2.25 left.

81. Seth grows strawberries in his garden.

- He picked $2\frac{1}{2}$ cups of strawberries on Monday.
- He picked 4 cups of strawberries on Tuesday.
- He ate $\frac{3}{4}$ cup of strawberries for breakfast each day on Wednesday, Thursday, and Friday.

How many cups of strawberries did Seth have left?

- A.** $3\frac{1}{2}$
- B.** $4\frac{1}{4}$
- C.** 6
- D.** 9

- 82.** Which situation involves quantities that combine to equal zero?
- E.** receiving \$5 as a gift and then giving \$5 to a friend
 - F.** buying a book for \$10 and then buying lunch for \$10
 - G.** getting on an elevator at the ground floor, rising 3 floors, and then rising 3 more floors
 - H.** starting in a cave 20 feet below the ground, climbing up 20 feet, and then climbing up 20 feet more

83.

$$\frac{\left(\frac{2}{3} - \frac{4}{5} \times \frac{1}{3}\right)}{\left(\frac{5}{3} + \frac{1}{4} \div \frac{3}{4}\right)} =$$

- A.** $-\frac{2}{115}$
- B.** $-\frac{1}{45}$
- C.** $\frac{2}{9}$
- D.** $\frac{1}{5}$

- 84.** An athlete runs $\frac{1}{8}$ kilometer in $\frac{3}{4}$ minute. At this rate, how many kilometers would the athlete run in 1 minute?

- E.** $\frac{3}{32}$
- F.** $\frac{1}{6}$
- G.** $1\frac{1}{2}$
- H.** 6

- 85.** A bus trip takes 9 hours if the mean speed is 50 miles per hour. How many hours would this trip take if the mean speed was 45 miles per hour?

- A.** 8
- B.** 10
- C.** 12
- D.** 14

-
- 86.** A birdseed mixture is $\frac{2}{5}$ sunflower seeds. The cost of the sunflower seeds is \$0.10 per ounce. At this rate, what is the cost of the sunflower seeds in 25 pounds of this birdseed? (Note: 1 lb = 16 oz.)
- E.** \$10.00
F. \$16.00
G. \$40.00
H. \$160.00

-
- 87.** A robot moves forward at the rate of 9 steps every 6 seconds. If each step is x feet long, what must x be in order for the robot to travel exactly 270 feet per minute?
- A.** 3
B. 5
C. 27
D. 30

- 88.** There were 36 people at Emily's party. If each person at the party drank 2 cups of juice, how many **gallons** of juice did they drink altogether?

Note: 1 gallon = 4 quarts;
1 quart = 4 cups.

- E.** $2\frac{1}{4}$
F. $4\frac{1}{2}$
G. 9
H. 72

-
- 89.** A student reads $\frac{1}{12}$ of a book in $\frac{1}{3}$ hour. What fraction of the book can the student read in 1 hour?

- A.** $\frac{1}{36}$
B. $\frac{1}{4}$
C. $\frac{5}{12}$
D. $\frac{12}{3}$

90. The perimeter of square W is twice the perimeter of equilateral triangle X. What is the ratio of the length of one side of square W to the length of one side of equilateral triangle X?

- E.** 3:8
- F.** 2:3
- G.** 3:2
- H.** 2:1

91. A recipe uses $\frac{2}{3}$ cup of sugar for every $1\frac{1}{4}$ cups of flour. A cook wants to increase the recipe. How many cups of sugar are needed for each cup of flour?

- A.** $\frac{8}{15}$
- B.** $\frac{5}{6}$
- C.** $1\frac{7}{8}$
- D.** $3\frac{2}{3}$

92.

READING ASSIGNMENTS

Assignment	Pages Assigned
I	3–17, inclusive
II	25–38, inclusive
III	45–60, inclusive

Over a two-week period, students are assigned a total of 250 pages to read from a science textbook. The table above shows the first three reading assignments within the larger assignment. What percentage of the 250 pages is the **total** number of pages in these first three assignments?

- E.** 16.8%
- F.** 18.0%
- G.** 22.8%
- H.** 24.0%

- 93.** A box contains an unknown number of green marbles. An experimenter adds 100 red marbles to the box, mixes the marbles thoroughly, and then draws out 10 marbles at random. Assume that this sample is representative of the proportion in the box. If there are 2 red marbles and 8 green marbles in this sample, approximately how many green marbles are in the box?
- A.** 80
B. 300
C. 400
D. 500

- 94.** A car costing \$24,000 is subject to a sales tax of 8%. If Bindu made a \$10,000 down payment on this car, what is the total amount she has left to pay?
- E.** \$14,000
F. \$15,620
G. \$15,920
H. \$25,920

95.

WINTER TEMPERATURES IN CHICAGO

Day	1	2	3	4	5	6	7
Temperature (°F)	17	7	2	4	-3	-5	1

The table above shows temperatures for a one-week period during the winter in Chicago. What is the range of temperatures shown in the table?

- A.** 12
B. 17
C. 22
D. 27

96.

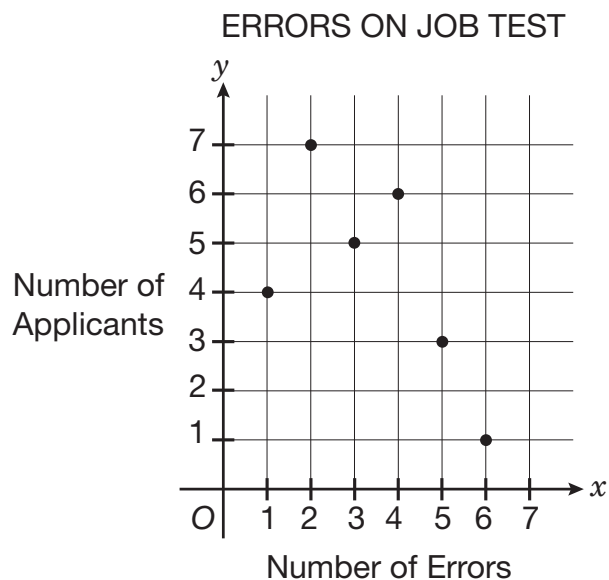

A total of 26 job applicants took a computer-competency test, and the number of errors (x) was recorded for each applicant. The graph above shows how many applicants made x errors, for each value of x . How many applicants made fewer than 3 errors?

- E. 6
- F. 11
- G. 12
- H. 26

97. Last week, Emily rode the bus to school on 3 of the 5 mornings and rode the bus home on 4 of the 5 afternoons. Based on last week's events, what is the probability that Emily will ride the bus in the morning and the afternoon next Monday?

- A. $\frac{1}{5}$
- B. $\frac{7}{25}$
- C. $\frac{12}{25}$
- D. $\frac{7}{10}$

98. XYZ Corporation hired 6 people as summer workers. Of these 6 people, 3 will be hired as permanent employees in the fall. If 2 of the 6 people are male, how many of the possible groups of 3 people hired in the fall will include **only** 1 male?

- E. 4
- F. 6
- G. 12
- H. 24

99. At any given time, one person out of every 20 people has the common cold. Assume that the common cold can be caused by any one of 200 different viruses, each of which is equally likely to cause the cold. One of these 200 viruses is cold virus V144. What is the probability that a randomly selected person is suffering from a cold caused by virus V144?

- A. $\frac{1}{10}$
- B. $\frac{1}{20}$
- C. $\frac{1}{200}$
- D. $\frac{1}{4,000}$

100. Karl has one red spinner and one blue spinner. Each spinner is divided into 4 equal sections, numbered 1 through 4. He spins each spinner once and writes down the number that each lands on. What is the probability that the two numbers, when multiplied together, will have 4 as a product?

- E. $\frac{1}{16}$
- F. $\frac{3}{16}$
- G. $\frac{4}{7}$
- H. $\frac{7}{16}$

101. Melissa has a bag of marbles that are all the same size. The bag contains three red (R) marbles, three green (G) marbles, and two white (W) marbles. For an experiment, she will take two marbles out of the bag without looking. Which list shows the sample space for Melissa's experiment?

- A. R, G, W
- B. RG, RW, GW
- C. R, R, R, G, G, G, W, W
- D. RR, RG, RW, GG, GW, WW

102. A graph shows the relationship between the number of gallons of water, y , that has been added to a tank and the number of hours, x , that water has been added to the tank at a constant rate. What does the ordered pair $(3, 24)$ represent?

- E.** Three gallons of water was added in 24 hours.
- F.** Three gallons of water was added per hour.
- G.** Twenty-four gallons of water was added in 3 hours.
- H.** Twenty-four gallons of water was added per hour.

103. The table shows the probabilities of a hockey team scoring different numbers of goals in a game.

HOCKEY GOAL PROBABILITIES

Number of Goals	Probability
0	0.16
1	0.21
2	0.29
3	0.21
4	0.09
5	0.04

What is the probability that the team will score three or more goals in the next game?

- A.** 0.13
- B.** 0.21
- C.** 0.34
- D.** 0.50

- 104.** This graph shows points that represent a proportional relationship between x and y .

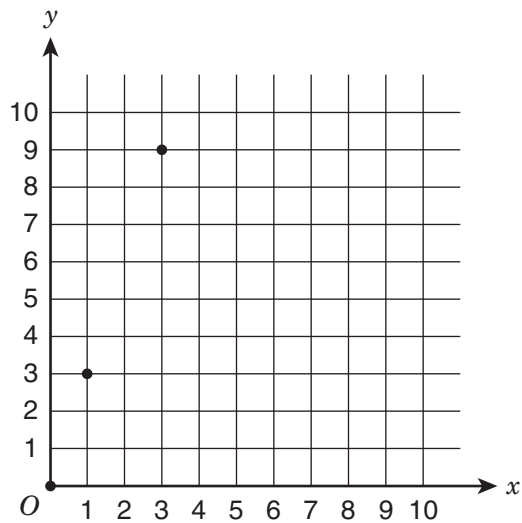

What is the constant of proportionality for this relationship?

- E.** 0
 - F.** 1
 - G.** 3
 - H.** 9
-
- 105.** The distance an eagle flies is proportional to the time the eagle spends flying. An eagle flies 90 miles in 3 hours. What is the constant of proportionality for this relationship?
- A.** 3
 - B.** 30
 - C.** 60
 - D.** 90

- 106.** A machine part is supposed to be 0.38 millimeters thick. The manufacturer allows a variation of -2.5% to $+2.5\%$. Which interval shows the range of acceptable thicknesses, in millimeters, for the part?

- E.** 0.285–0.475
- F.** 0.355–0.405
- G.** 0.3705–0.3895
- H.** 0.3724–0.3876

-
- 107.** A bakery charges \$1.25 for each cupcake and \$2.50 for a serving tray. The equation describes p , the price of c cupcakes and a serving tray, not including tax.

$$p = 2.50 + 1.25c$$

If Samantha bought some cupcakes and a serving tray for a total of \$22.50, not including tax, how many cupcakes did she buy?

- A.** 4
- B.** 9
- C.** 16
- D.** 18

108. A clothing store buys shirts for a cost of m dollars each. To determine the selling price of the shirts, the manager increases the purchase cost by 55%. Which expression represents the selling price of each shirt?

- E.** $0.45m$
- F.** $0.55m$
- G.** $1.55m$
- H.** $m + 0.55$

109. A farmer has 100 apples and will eat 2 apples per day. Is there a proportional relationship between the number of apples remaining and the number of days that have passed?

- A.** no, because the relationship does not include 99 as a number of apples
- B.** no, because the ordered pair $(0, 0)$ is not part of the relationship
- C.** yes, because all the values in the relationship are even
- D.** yes, because the number of apples is decreasing at a constant rate

110.

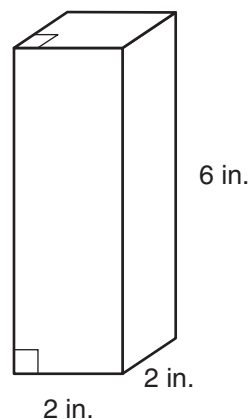

What shape will result from a horizontal slice of the figure above?

- E.** a square that has 2-inch sides
- F.** a triangle that has 2-inch sides
- G.** a rectangle that has a 2-inch side and a 6-inch side
- H.** a triangle that has one 2-inch side and two 6-inch sides

111. Anise has a piece of cloth measuring 45 inches by 75 inches. She wants to cut it into squares of equal size, without any cloth left over. What is the **greatest** possible side length, in inches, of one of those squares?

- A.** 3
- B.** 5
- C.** 15
- D.** 45

- 112.** This table shows the number of birds that came to a bird feeder on Monday and Tuesday.

BIRDS AT BIRD FEEDER

Day	Number of Birds
Monday	30
Tuesday	24

What was the percent decrease in the number of birds from Monday to Tuesday?

- E.** 6%
- F.** 20%
- G.** 24%
- H.** 25%

- 113.** A team is participating in a contest to collect canned goods for a food drive. The team has 53 points and must have a total of at least 100 points to win a prize. The team earns 5 points for each can of food a member collects. Which inequality can be used to find x , the number of cans of food the team needs to collect to win a prize?

- A.** $5 + 53x \leq 100$
- B.** $5 + 53x \geq 100$
- C.** $53 + 5x \leq 100$
- D.** $53 + 5x \geq 100$

- 114.** A store manager purchases a piece of furniture for \$456.00. To determine the selling price, the manager increases the purchase cost by 125%. A customer buys the furniture and pays an additional 8% sales tax. How much does the customer pay for the furniture?

- E.** \$615.60
- F.** \$627.48
- G.** \$1,108.08
- H.** \$1,846.80

THIS IS THE END OF THE TEST.
IF TIME REMAINS, YOU SHOULD CHECK
YOUR ANSWERS. BE SURE THAT THERE
ARE NO STRAY MARKS, PARTIALLY
FILLED ANSWER CIRCLES, OR
INCOMPLETE ERASURES ON YOUR
ANSWER SHEET. ■

REVISING/EDITING PART A

1. The question asks for the revisions that are needed to correct errors in the paragraph.
 - A. Incorrect. The revisions introduce new errors. The colon after “wonder” is needed to set off the question “what is the difference between the two?” from the rest of the sentence. In addition, changing the verb “is” to “are” would be incorrect with the use of the singular noun “difference,” which is the subject of the question.
 - B. Incorrect. The revisions introduce new errors. The comma following the introductory phrase “To start with” helps with clarity and is needed to separate the phrase from the rest of the sentence. Changing “it is” to “they are” would be incorrect with the use of the singular noun “butterfat content,” which is what the words “it is” refer to in the sentence.
 - C. Incorrect. The revisions introduce new errors. The comma following “process” is necessary to set off the nonrestrictive clause “which adds less air to the frozen treat” from the rest of the sentence. This clause is considered a nonrestrictive clause because it provides additional, but not essential, information about the mixing process. Changing the verb “makes” to “make” would be incorrect with the use of the singular noun “mixing process,” which is the subject of the sentence.
 - D. **CORRECT.** Deleting the comma after “gelato” would include the clause “and allow it to melt more quickly” with the first part of the clause “which enhances the texture and flavor of the gelato.” The word “and” between the two verb phrases (“enhances the texture and flavor of the gelato” and “allow it to melt more quickly”) indicates that the two verb phrases share a subject, “which” (referring to the act of serving gelato 10 to 15 degrees warmer than ice cream). The two ideas should not be separated by a comma within the clause. The entire clause “which enhances the texture and flavor of the gelato and allow it to melt more quickly” should be separated from the main clause only by the comma after “cream” because the entire clause is a nonrestrictive clause. This clause provides additional, but not essential, information about the purpose of serving gelato at a warmer temperature than ice cream. Changing the verb “allow” to “allows” is also necessary to match the use of the singular pronoun “which.”

2. The question asks for the **best** way to combine the sentences.
- E. Incorrect. Although the sentence incorporates the ideas presented in the three original sentences, it is incorrect because the combination suggests an incorrect relationship between the ideas. By beginning with “Io,” the sentence places emphasis on the moon and the detail about the number of active volcanoes rather than the key idea that “scientists now believe that Jupiter may have as many as seventy-nine moons.” Since Io is an example of one of Jupiter’s moons, the details about Io should follow and be subordinate to the main clause, which provides new information about the number of Jupiter’s moons in general.
 - F. Incorrect. Although the sentence incorporates all three ideas from the original sentences and correctly places the detail about the number of active volcanoes on Io in a dependent clause, this option is incorrect because it presents an imprecise relationship between the ideas. By using the conjunction (connecting word) “and,” the sentence construction suggests that scientists “now believe” that “Jupiter may have as many as seventy-nine moons” and that “one of them is named Io,” instead of presenting Io as an example of one of Jupiter’s moons.
 - G. **CORRECT.** This sentence is the best way to combine the original sentences because it uses a complex sentence to present ideas clearly and precisely, and it shows the relationship between the ideas in the original sentences. The sentence starts by stating the number of moons scientists now believe Jupiter may have and then specifies that one of those moons is named Io. The dependent clause “which has the greatest number of active volcanoes in the solar system” immediately follows the word “Io” to provide additional information about the moon. A dependent clause contains a subject (“which,” referring to Io) and a verb (“has”) but is not a complete sentence on its own.
 - H. Incorrect. The sentence incorporates the key ideas from the original sentences, but its structure does not accurately present the relationship between these ideas. The beginning of the sentence includes the detail about Io having “the greatest number of active volcanoes in the solar system” before specifying that Io is one of the seventy-nine moons of Jupiter. The presentation of the details about Io at the beginning lessens the emphasis of the key idea that “scientists now believe that Jupiter may have as many as seventy-nine moons.”

3. The question asks for the identification of the sentence that contains an error in its construction and should be revised.
- A. Incorrect. There are no errors in sentence 1. The singular pronoun “its” matches the number of the word it refers to, the singular noun “blobfish.” Additionally, the clause “a creature that certainly resembles its name” is correctly set off by commas to provide an additional, but not essential, detail about the blobfish. The comma separating “pink” and “gelatinous” is correct because these are coordinate adjectives.
 - B. Incorrect. There are no errors in sentence 2. The singular pronouns “it” and “its” match the number of the word they refer to, the singular noun “blobfish.” Additionally, the structure of the sentence correctly shows that the clause “Because it has very few muscles and its density is close to that of water” modifies the words “the blobfish.”
 - C. Incorrect. There are no errors in sentence 3. The “it” and “its” in the sentence refer to “the blobfish” mentioned in the previous sentence. The use of singular pronouns in sentence 3 is consistent with the rest of the paragraph.
 - D. **CORRECT.** Sentence 4 contains an error because the sentence uses the plural pronoun “them” to refer to “The blobfish’s,” which is singular in number. The word “them” should be changed to “it.” The paragraph refers to the blobfish as a singular species in each of the four sentences, and sentence 4 should be revised to match.
-

4. The question asks for the identification of the sentence that has an error in its construction and should be revised.
- E. Incorrect. There are no errors in the structure of sentence 1. The clause “who played in the Long Island area at the time” correctly modifies the noun “New York Nets.” “Who” is the correct relative pronoun to serve as the subject of the modifying clause because it refers to people rather than objects or things.
 - F. **CORRECT.** Sentence 2 contains a structural error. The current placement of the clause “where the team played for thirty-five seasons” suggests that the clause is modifying the term “financial troubles,” which is illogical. The clause “where the team played for thirty-five seasons” should immediately follow the location, “New Jersey.” A revised version of the sentence might read, “After the team had financial troubles, the owner of the Nets decided to take the team to New Jersey, where the team played for thirty-five seasons.”
 - G. Incorrect. There are no errors in the structure of sentence 3. The phrase “including two appearances in the NBA finals” is a nonrestrictive phrase that provides further detail about the team’s “sixteen playoff appearances.” The phrase is set off by a comma because it is not essential to understanding the meaning of the sentence.
 - H. Incorrect. There are no errors in the structure of sentence 4. The clause “where the team now plays under the name the Brooklyn Nets” is a nonrestrictive clause that provides further detail about the team after its move back to New York in 2012. The clause is set off by a comma because it is not essential to understanding the meaning of the sentence.

REVISING/EDITING PART B

Moving Through Mountains

5. The question asks which sentence should be added to the end of the first paragraph in order to introduce the topic of the passage, which is the description, construction, and use of the Gotthard Base Tunnel.
- A. Incorrect. The option is incorrect because it offers information about the funding used to build the Gotthard Base Tunnel but does not provide a description of the tunnel.
 - B. Incorrect. The option is incorrect because it gives details about the opening ceremony of the tunnel but does not provide a description of the tunnel.
 - C. **CORRECT.** The option correctly presents and describes the Gotthard Base Tunnel.
 - D. Incorrect. The option is incorrect because it offers a result of completing the Gotthard Base Tunnel rather than offering an introductory statement presenting and describing the tunnel.
-
6. The question asks for a sentence that provides additional details about the tunnel-boring machines used to build the Gotthard Base Tunnel in order to support the description of the machines in sentence 7.
- E. Incorrect. The option is incorrect because it offers information about how tunnel-boring machines were an improvement over previous methods but does not include information about how the machines work.
 - F. **CORRECT.** The option is correct because it offers specific details about how tunnel-boring machines, such as the ones used to create the Gotthard Base Tunnel, drill through rock.
 - G. Incorrect. The option is incorrect because it presents the idea that the tunnel could not be built until advances were made in tunnel-boring machine technology and does not describe how the machines function.
 - H. Incorrect. The option is incorrect because, though it explains that there are different types of cutter heads used for different geologies, the geology of the tunnel area is not discussed in sentence 7 or in the rest of the paragraph.

7. The question asks where sentence 11, which completes the detailed steps of how the tunnel was built, should be moved within the second paragraph in order to improve the organization of the paragraph.
- A. Incorrect. The option, placing the sentence at the beginning of the paragraph (before sentence 6), is incorrect because it would not make sense since the process of building the tunnel has not yet been introduced.
 - B. Incorrect. The option is incorrect because placing the sentence after sentence 6 would not make sense given that adding concrete would have to happen after the rock was broken down and removed from the tunnel.
 - C. Incorrect. The option, placing the sentence between sentences 8 and 9, would be incorrect because the use of concrete did not take place before the removal of “28 million tons of rock” (sentence 9).
 - D. **CORRECT.** The option, placing the sentence between sentences 9 and 10, is correct because placing the sentence there helps the reader understand the full sequence of steps performed in constructing the tunnel before the cost of the project is introduced.
-

8. The question asks which sentence should be removed because it presents an idea that shifts away from the main idea of the third paragraph, which is about the transportation benefits of the Gotthard Base Tunnel.
- E. Incorrect. The option (sentence 13) is incorrect because the idea of faster travel times is important to the development of the main idea of the paragraph.
 - F. Incorrect. The option (sentence 14) is incorrect because the sentence provides a specific example of decreased travel time between two cities when traveling through the Gotthard Base Tunnel, supporting the development of ideas in the paragraph.
 - G. Incorrect. The option (sentence 15) is incorrect because the sentence compares the Gotthard Base Tunnel to another tunnel that provides an important connection between places; thus, the sentence supports the idea that transportation innovations are beneficial.
 - H. **CORRECT.** The option (sentence 16) is the correct response because, even though the sentence provides additional information about the Channel Tunnel, it does not help the reader understand the benefits of the Gotthard Base Tunnel.

9. The question asks for a transition that bridges the ideas between sentences 17 and 18 and accurately presents the relationship.
- A. Incorrect. The option is incorrect because the use of the word “although” and the mention of freight trains suggest that sentence 18 will be about other types of vehicles that use the Gotthard Base Tunnel, and the transition phrase does not logically precede the sentence.
 - B. Incorrect. The option is incorrect because the reference to the amount of time it took to build the tunnel does not help lead into the idea presented in sentence 18.
 - C. **CORRECT.** The option is correct because it bridges the sentences by referring to the Gotthard Base Tunnel as a solution to the problems described in sentence 17 and logically introduces sentence 18.
 - D. Incorrect. The option is incorrect because it suggests that sentence 18 is related to the increasing number of trains using the Gotthard Base Tunnel, which is not accurate.
-
10. The question asks for a concluding sentence that supports key ideas about the topic developed earlier in the passage.
- E. Incorrect. The option is incorrect because the economies of surrounding areas are never mentioned in the passage.
 - F. **CORRECT.** The option is correct because it supports the points made in the introductory paragraph by affirming the idea that the Gotthard Base Tunnel is an example of a way people have improved life by overcoming obstacles.
 - G. Incorrect. The option is incorrect because, although the construction of the Gotthard Base Tunnel appears to have required many people to work together, the passage does not explicitly mention people or groups working together.
 - H. Incorrect. The option is incorrect because it focuses on the cost of the Gotthard Base Tunnel, which is referred to only in sentence 10 of the passage.

READING COMPREHENSION

Excerpt from "The World Has an E-Waste Problem"

11. The question asks about the effect of the words “twisted,” “doomed,” and “unrelenting” on the last sentence of paragraph 1.
- A. **CORRECT.** Paragraph 1 first describes the problem of discarded devices in terms of the scope of the problem (“about 6 million pounds . . . processed monthly”). The author then elaborates on the problem with a vivid description of the actual process; it is unfortunate that this process is necessary because, even though they are relatively new, these devices are no longer useful. These particular words emphasize the process of a once-useful device becoming a part of a “twisted . . . movie,” and “doomed” to be recycled by going through an “unrelenting” or never-ending conveyor belt.
 - B. Incorrect. In the excerpt, the author does express concern about the amount of waste from discarded devices, but this particular sentence is about what happens to the devices and the perspective that one has while watching the devices as they are being processed. In this description, the once-beloved devices have been destroyed, with only some useful parts being retained.
 - C. Incorrect. Although there is an indication in paragraphs 4–6 that some obsolete devices are disposed of inappropriately, this description is of an appropriate disposal—a recycling center developed specifically for these types of devices.
 - D. Incorrect. At this juncture in the excerpt, the author has not yet mentioned solving the problem of discarded devices; rather, the author is describing what happens to discarded devices that are appropriately recycled.
-
12. The question asks how paragraph 2 expands upon the reader’s understanding from paragraph 1.
- E. **CORRECT.** Paragraph 1 describes massive amounts of recycling (“about 6 million pounds . . . processed monthly”). Paragraph 2 then explains the underlying reason for so much electronics recycling, using a quote from a resource: “ ‘we always have to have the new, best product,’ ” so we buy new electronic products and “get rid of what’s old.”
 - F. Incorrect. The trend outlined in paragraph 2 is not one of the past but rather one that is ongoing and even increasing at an alarming rate; in only seven years, American consumers quintupled their spending on “telephone and communication equipment.”
 - G. Incorrect. While it is true that paragraph 2 presents a statistic about American consumer patterns from 2010 to 2017, the spending on these items does not directly support any claims about waste problems. Specific statistics about waste generation, as opposed to this statistic related only to spending, would better support this type of claim.
 - H. Incorrect. Although paragraph 2 mentions that consumers “get rid of what’s old” once “we buy something new,” this is merely a statement of fact and not a judgment about this behavior.

13. This question asks for the **best** support from the excerpt for the idea that electronic devices are purposely designed to be disposed of after a short time.

- A.** Incorrect. This statement actually contradicts the notion that it is the manufacturers who are at fault for designing products to only last a short while, as it suggests that the desire for upgrading electronic devices comes directly from consumers themselves.
 - B.** Incorrect. Though this explains a problem that occurs after the devices have already been upgraded, it provides no support for the idea that these devices are intentionally designed to become obsolete quickly.
 - C. CORRECT.** This explains the techniques manufacturers of these devices implement to make the devices unusable after a short time. They cannot easily be repaired; they cannot be integrated with legacy components, and older devices are unable to run with new software.
 - D.** Incorrect. This sentence explains that some people feel that these companies should accept responsibility for creating such short-lived devices, but it does not directly indicate that they intentionally make devices to become useless after only a short time.
-

14. The question asks how paragraphs 4–5 develop a central idea of the excerpt.

- E.** Incorrect. Though “e-waste can contain harmful materials like mercury and beryllium” (paragraph 4) and recycling it “can be dangerous” (paragraph 5), the reluctance of recyclers to take e-waste is not a central idea of the excerpt. The excerpt indicates that some recycling companies, like ERI, take electronics and process many of them.
- F.** Incorrect. It is true that “only 19 states” have laws about not putting old electronics in the trash (paragraph 5), but these paragraphs do not discuss any other approaches that certain communities across the country have tried to implement.
- G. CORRECT.** These paragraphs highlight problems that already exist and that have been made worse by increasing amounts of e-waste: too much e-waste that is “incinerated or ends up in landfills” and the environmental problems this creates (paragraph 4), as well as the fact that “electronics often end up in garbage and recycling bins” even though they do not belong there (paragraph 5). This develops the central idea in that increasing e-waste is yet another human-made environmental problem that adds layers to the existing problems with too much trash and environmental degradation.
- H.** Incorrect. There is some indication in these paragraphs that disposing of e-waste creates new and specific problems. However, this is not one of the central ideas of the excerpt, as the problem is more complex than this and involves the design of these devices as well as people’s lack of knowledge and willingness to dispose of these devices appropriately.

- 15.** The question asks about the role of paragraphs 7–9 in the overall organization of the excerpt.
- A.** Incorrect. These paragraphs make proposals for new efforts to regulate electronic waste, such as producing devices that last longer and having device-producing companies pay to have the devices recycled; however, no claims are made about these efforts being successful.
 - B.** Incorrect. Paragraph 7 does suggest that today’s devices do not “last as long as they once did,” but it does not indicate that in the past electronic devices led to less pollution. Presumably, technology related to electronics recycling has improved in recent years.
 - C.** Incorrect. While it is true that paragraphs 8 and 9 suggest that electronics manufacturers, who are part of the problem, will also need to be part of the solution, there is no call for regulations in these paragraphs, as it was previously established in paragraph 5 that such regulations do not yet widely exist.
 - D. CORRECT.** Paragraph 6 references consumers who may be “paralyzed by the hassle or put off by the expense” and thus do not recycle their devices correctly. Paragraphs 7–9 then shift the focus from individual consumer behaviors to the responsibility of the manufacturers of these devices, who might take action either by making their devices “last as long as they once did” (paragraph 7) or by making efforts to “recycle or collect obsolete products” (paragraph 8).
-

- 16.** The question asks how a point about the ineffectiveness of e-waste regulations is conveyed in the excerpt.
- E.** Incorrect. Paragraph 5 indicates that “only 19 states have laws banning electronics from the regular trash,” but this statistic does not reveal how effective or ineffective these regulations are.
 - F. CORRECT.** Paragraph 6 explains that “even when e-waste rules exist,” it is possible consumers will not follow them, because they have to return their electronics to a store and could be charged. Because it is such a “hassle,” they will “simply throw their devices into the trash or stash them in a drawer, hoping they’ll just disappear” (paragraph 6).
 - G.** Incorrect. While stores may charge people “to get rid of” old devices (paragraph 6), the fee will simply cover expenses incurred by the store to properly dispose of the devices. Stores could actually succeed in getting some devices recycled appropriately, but overall, the excerpt states that consumers’ frustration over the process means most are discarded improperly (paragraph 6).
 - H.** Incorrect. Paragraph 9 explains that “some companies are increasing their recycling efforts on their own,” but this does not mean that regulations are ineffective, only that some manufacturers are taking action even without regulations.

17. The question asks how the diagram after paragraph 9 supports the claim in paragraph 4 about environmental risks from e-waste.
- A. Incorrect. The diagram includes an image of people as well as an “unlined landfill,” but it contains no information about the volume of e-waste that people place in the landfill. Rather, it seeks to show how waste in landfills impacts the environment in a broader sense through “air emissions” and “groundwater” contamination.
 - B. **CORRECT.** The diagram shows that toxic chemicals that are placed into an “unlined landfill” can produce “air emissions” that may affect rain and trees. These toxic chemicals may also seep into the soil and then, eventually, into the “groundwater” and “surface water.”
 - C. Incorrect. While it is true that the landfill in the diagram is labeled an “unlined landfill,” which presumably would allow more pollutants to seep into the soil, no claim is made in paragraph 4 about landfill design.
 - D. Incorrect. The diagram shows that water sources near landfills are at risk of pollution by anything in the landfill, but the diagram makes no mention of e-waste in particular.
-

Excerpt from *The Highest Tide*

18. The question asks what idea the phrase “the butterflies of the sea” in paragraph 3 conveys.
- E. Incorrect. While the narrator does say that they “taste so lousy they don’t need camouflage to survive” (paragraph 3), the phrase explains that their bright appearance poses no threat to their lives.
 - F. **CORRECT.** The narrator describes the vibrant colors of the nudibranch in paragraph 2. Then in paragraph 3, the narrator says that “their beauty is so startling.” The nudibranchs are colorful and unique, just as many butterflies are.
 - G. Incorrect. The narrator describes the distinct appearance of the nudibranch but does not suggest that nudibranchs struggle to adapt to their environment because of this trait.
 - H. Incorrect. In paragraph 2, the narrator states, “I’d handled them at aquariums but never in the wild, and I’d never even seen a photo of one this stunning.” Although this suggests that the narrator has rarely encountered a nudibranch in the wild, it does not suggest that they are rare in the wild in general.

- 19.** The question asks for an explanation of how selected sentences from paragraph 4 contribute to the overall structure of the excerpt.
- A.** Incorrect. These sentences set a tense and mysterious tone for what is about to happen in the excerpt, but they do not introduce the creature the narrator discovers.
 - B.** Incorrect. While the narrator reveals that he is familiar with the terrain (“I knew exactly what the bars looked like in the moonlight”), this does not show the narrator recalling the past or reflecting on the present; it demonstrates the narrator’s knowledge of the mudflats.
 - C.** Incorrect. These sentences reveal the narrator’s curiosity, which is his prime motivation for venturing out to the mudflats, and his familiarity with the terrain shows that at this point, he does not feel afraid.
 - D. CORRECT.** The narrator creates a feeling of mystery and suspense with language that shows how the situation is unknown. Phrases such as “I couldn’t resist” and “I’m not sure why” reveal the narrator’s curiosity, as well as the tension of feeling drawn to explore the mudflats in the moonlight.
-

- 20.** The question asks which sentence from paragraph 5 supports the idea that the narrator is taking a risk.
- E.** Incorrect. In this sentence, the narrator is describing the exhale of a creature and his concern that the sound might be coming from a whale in danger. At no point does the narrator suggest that this is a dangerous situation.
 - F.** Incorrect. This sentence describes a “hulking silhouette” because the narrator is searching for a whale that might be stranded. This expression refers to the size of the whale and not to any danger the narrator might face.
 - G.** Incorrect. The narrator’s words “no more sounds” are used to illustrate his listening for what may be a whale. At this point, the narrator is still concerned about the possibility that a whale may be stranded, not the possibility of being in danger.
 - H. CORRECT.** The idea that the narrator could become stuck in the mud of the flats means that the surroundings pose some danger or difficulty.

- 21.** The question asks how the narrator’s actions, as described in the sentence from paragraph 6, develop a central idea of the excerpt.
- A.** Incorrect. The sentence highlights the narrator’s concern about sea life and the creatures living within the flats. However, these ideas do not develop what is being described in the excerpt.
 - B. CORRECT.** The narrator “kept stepping toward the one sound,” indicating a sense of curiosity. However, the words “a growing part of me hoping I’d find nothing” suggest a rising fear or concern. Ultimately, the narrator’s curiosity outweighs his growing fear and is a central idea in the excerpt, as shown by the fact that the narrator does not run away when finally encountering the creature.
 - C.** Incorrect. While the narrator’s descriptions of the nudibranch and other sea life demonstrate a knowledge of these creatures, as well as a desire to discover more in the mudflats, the knowledge the narrator exhibits is not what is being illustrated in the excerpt.
 - D.** Incorrect. The excerpt does describe the narrator’s enjoyment at seeing a nudibranch in paragraph 2, and in paragraph 4, the narrator clearly states that there is an abundance of life in the seemingly barren mudflats, including “hearty clams, worms and tiny creatures that flourish in mud.” However, the sentence demonstrates the narrator’s curiosity in spite of fear, not an eagerness about or fascination with the mudflats.
-

- 22.** The question asks what the sensory language in the sentences from paragraph 8 conveys about the narrator.
- E.** Incorrect. While the narrator does not leave the mudflats and is curious about what has been found, the main emotions described in paragraph 8 are fear and confusion as the narrator tries to comprehend the size of the animal.
 - F.** Incorrect. The language focuses on the narrator’s inability to organize what he sees into useful thoughts and conclusions, and while the narrator feels fear in paragraph 8—“I was afraid” and “I would have run”—the narrator refuses to leave the mudflats out of curiosity.
 - G. CORRECT.** The phrase “spangled my vision” illustrates that the narrator cannot fully recognize what has appeared on the mudflats. The sight is so amazing, the narrator is trying to “fuse” together “fragments” and “pieces” because seeing the creature has created so much emotion in the narrator that he feels confused.
 - H.** Incorrect. While the narrator is feeling some fear, as expressed in paragraph 8, the phrases actually indicate that the narrator’s amazement causes him to struggle to take in the view of the creature before him.

- 23.** The question asks how the author develops the narrator’s point of view when the narrator sees the creature.
- A.** Incorrect. The author’s description of how the narrator moves toward the creature has to do with the terrain and the narrator’s sense of awe. The narrator’s perspective is not represented through how he approaches the creature; it is presented later in the excerpt when the narrator is studying the creature.
 - B.** Incorrect. In this excerpt, while the narrator does discuss other large animals (minke whale, paragraph 5; octopi, paragraph 7) that have appeared on the mudflats, these are examples to show the variety of animal life that can be discovered on the mudflats, not rivals of the creature discovered at the end.
 - C. CORRECT.** In paragraph 7, the narrator describes the largest octopi in the world and then states that this creature is “more than an octopus.” The narrator then states that it is “impossible to hear anything over the blood in my ears,” and in paragraph 8, he describes the creature’s body in detail, as well as his growing fear and amazement as he begins to realize what the creature really is.
 - D.** Incorrect. While the narrator observes that the creature’s eye is as large as a hubcap in paragraph 9, a comparison to an entire car is never made. This detail is for description but does not give the narrator’s point of view.
-

- 24.** The question asks how the setting affects the plot of the excerpt.
- E. CORRECT.** In paragraph 4, the narrator says that it is an hour before sunrise. It is difficult to see because the mudflats are dark, so the narrator, while familiar with the terrain of the mudflats, is cautious.
 - F.** Incorrect. While the terrain of the mudflats is challenging because of the “wet, flattened dunes” (paragraph 4), the narrator is familiar with the terrain and moves carefully. In addition, the excerpt shows that the narrator explores the mudflats for curiosity and enjoyment, not work.
 - G.** Incorrect. In paragraph 1, the narrator watches the water “hesitating at its apex” and “patiently waiting for the gravitational gears to shift.” This illustrates that the narrator is already familiar with the changes in his surroundings, that the tide is slow to move in, and that he can move carefully through the mudflats without the threat of rising water.
 - H.** Incorrect. While the narrator is on the mudflats for the entire excerpt, the phrase “eyes relaxed” in paragraph 1 indicates that the narrator feels comfortable there. The narrator does not show fear until paragraph 6, when a growing fear about the unknown creature arises.

Going Solar in China

- 25.** The question asks for an explanation of the effect of two phrases in paragraph 1 that describe the solar panels on the lake.
- A.** Incorrect. The phrases describe the size of the solar panels, but they do not provide any information about the amount of energy that the solar panels produce in relation to the size of the solar farm.
 - B.** Incorrect. Despite the descriptions of the size of the solar-power farm, the phrases quoted do not indicate how much power is produced by the farm or how much energy is required by the surrounding area.
 - C.** Incorrect. The description of the floating solar panels on the “rippling surface of a lake” provides a sense of the landscape, but it does not necessarily suggest that the solar panels blend into the landscape.
 - D. CORRECT.** The number of solar panels suggests that the solar farm produces a great deal of energy, and the description of the solar panels floating on the lake shows that the solar farm is in a unique or unusual location.
-
- 26.** The question asks for the author’s purpose in including statements from Dajie in paragraphs 2 and 7.
- E.** Incorrect. In paragraph 2, the author explains that Dajie previously had a job in a coal mine, and his statement compares the two jobs. The paragraph does not focus on jobs as a major benefit of the solar-energy industry.
 - F.** Incorrect. In paragraph 2, the author explains why the solar farm was built in this particular location by detailing how the coal mine was flooded and a lake was created. This particular event does not provide an explanation of why coal is being replaced by solar energy, and the conditions in the mine described by Dajie in paragraph 2 were not a factor in the switch from coal to solar power.
 - G. CORRECT.** The description of the working conditions in the mine that Dajie provides in paragraph 2 shows that improved working conditions are a benefit of the change from coal to solar power. In paragraph 7, Dajie’s statement suggests that the change is a better use for the land and also that it will “create a better future.” These statements address the benefits of solar power that are not related to economics.
 - H.** Incorrect. Dajie’s statement that the coal mine was hot and dangerous is used to emphasize the difference between the two power sources, but it is not used to suggest that more solar farms should be built. Although, in paragraph 7, Dajie expresses gratitude about the solar farm and its role in creating “a better future,” he does not explicitly call for creating more farms in the province.

27. The question asks how paragraph 2 contributes to the development of ideas in the article.
- A. Incorrect. The details in paragraph 2 explain how the coal mine was flooded and later turned into a solar farm. Dajie’s experience is used to highlight the differences between the two forms of energy, but the transition from coal to solar and the differences between the two, rather than Dajie, are the focus of the paragraph.
 - B. **CORRECT.** Dajie’s comparison of the coal mine and the solar farm is used to highlight the improved working conditions for energy workers, and the last two sentences of the paragraph describe the air pollution created by coal power and explain the environmental benefits of solar power. Therefore, this paragraph shows how transitioning from coal to solar power benefits both workers and the environment.
 - C. Incorrect. The first sentence of the paragraph explains how the lake was formed, but the reasons the location was chosen by the energy company are not a central idea of the article or the paragraph. The paragraph focuses on the advantages of solar power compared with coal power.
 - D. Incorrect. Although the author does explain how the area was affected by a flood at a coal mine that created a lake, the process of the lake becoming a solar farm is not a central idea of the paragraph. Instead, the paragraph focuses on the differences between the mine and the solar-power farm.
-

28. The question asks for an explanation of how the structure of paragraphs 4–5 contributes to the development of ideas.
- E. Incorrect. While paragraph 5 does explain that the cost of solar panels declined as manufacturers increased production to meet demand, the chronological structure does not specifically detail how the businesses lowered the cost of solar energy over time.
 - F. Incorrect. While paragraph 5 states that “In order to make manufacturing a profitable industry again, the Chinese government offered its own financial incentives to Chinese citizens for using solar energy,” this occurred only after there was a surplus of solar panels in China. Overall, the article does not explain or detail the Chinese government’s role in the solar-energy industry, specifically the government’s response to the international demand discussed at the end of paragraph 4.
 - G. **CORRECT.** The author uses a chronological structure to show how Chinese businesses responded to the growing demand for solar power after first being uninterested in it. The author goes on to explain how the Chinese government took an interest in solar power and began promoting it to help Chinese businesses. This shows a change over time in the Chinese approach to solar power.
 - H. Incorrect. Although the paragraphs do suggest that the manufacturers improved their efficiency to meet demand, the chronological structure does not specifically show how the manufacturers changed and improved their processes.

29. The question asks how the details in paragraph 6 convey a main idea of the article.
- A. Incorrect. The details in paragraph 6 help explain that China has a goal of increasing its use of solar power, but there is no information in the paragraph to suggest that the Chinese government wants to make China a world leader in solar energy. The only goal discussed is the government's goal to use renewable energy sources to meet 20 percent of the country's energy needs by 2030.
 - B. **CORRECT.** The discussion of a second solar farm and the government's goal to increase its reliance on "low-emission power plants" shows that the Chinese government understands the benefits of solar energy and other renewable energy sources.
 - C. Incorrect. Paragraph 6 addresses the Chinese government's focus on increasing its use of renewable energy and low-emission power. The topic of excess solar panels is not discussed in paragraph 6; instead, the topic is mentioned in paragraph 5.
 - D. Incorrect. The paragraph explains that the goal of the Chinese government is to increase the use of renewable energy so that 20 percent of the country's power comes from such sources by 2030. However, this goal would not make solar power the main source of energy in China.
-

30. The question asks how the article illustrates China's role in the growth of global solar-energy use.
- E. Incorrect. In paragraphs 4 and 5, the author explains that Chinese businesses manufactured solar panels to meet demand from European countries; however, the paragraph does not specify that those countries used the panels in solar-power farms.
 - F. Incorrect. Although paragraph 4 does explain the early use of solar power in China, the paragraph only explains the developing Chinese business of making solar panels. It does not suggest that solar-power use in China, as opposed to solar-power use in other countries, demonstrated that solar power could replace other energy sources.
 - G. Incorrect. In paragraph 5, the author explains how the Chinese government offered incentives for its own citizens to promote solar energy, but this action served only to increase solar-power use in China. No connection is made between the incentives offered to Chinese citizens and the global increase in solar-power use.
 - H. **CORRECT.** Paragraphs 4 and 5 explain how growing demand for solar power encouraged China to improve manufacturing; this "lowered the worldwide cost of using solar energy by 80 percent" (paragraph 5). The affordability of solar energy contributed greatly to the increased global use of that energy source.

- 31.** The question asks how the author’s purpose is conveyed in the article.
- A. CORRECT.** Throughout the article, the author provides details about the positive outcomes of China’s focus on solar and renewable energy. In paragraph 2, the author discusses the improvements in working conditions and the environmental benefits of renewable energy, and in paragraphs 4 and 5, the author focuses on how Chinese businesses benefited from producing solar panels. In paragraph 6, the author discusses the increase in China’s use of solar and renewable energy before concluding in paragraph 7 that this change will create a better future.
 - B.** Incorrect. Based on paragraph 4, the demand for solar power was initiated by countries such as Germany, Spain, and Italy. China responded to these demands but did not influence the other countries to use solar power.
 - C.** Incorrect. While the author does discuss China’s use of coal power, the author focuses on the developments regarding solar power in China rather than on other forms of energy.
 - D.** Incorrect. The author does explain that Chinese businesses became interested in solar power for financial reasons, but the author does not focus on the economic benefit or impact of solar power on China. Instead, the author focuses on the other benefits of solar and renewable energy.
-

- 32.** The question asks how the details about other countries in paragraph 4 help develop a central idea of the article.
- E. CORRECT.** The different countries are mentioned in paragraph 4 to explain how the actions of these countries increased the demand for solar panels. As a result, Chinese businesses increased their production and then improved their production methods to become more efficient to meet the demand.
 - F.** Incorrect. The author explains that the governments of these countries offered incentives for people to use solar power, but the actions of these countries do not show a global need for solar power.
 - G.** Incorrect. The discussion of the European countries focuses on the actions taken by the governments to encourage the growth of solar power in their own countries, but it does not suggest that the countries were competing with one another.
 - H.** Incorrect. Although China created a solar-power farm in an unusual place, there is no information provided about how solar-power farms were constructed in other countries.

Excerpt from "How Exercise Could Help You Learn a New Language"

- 33.** The question asks how the author’s use of comparison in paragraphs 4 and 5 contributes to the development of ideas in the excerpt.
- A.** Incorrect. Paragraph 5 does not claim that adults are never able to learn a second language, only that “it becomes harder to learn a second language after childhood.”
 - B.** Incorrect. The issue of physical activity is never addressed in these paragraphs. They compare the relative ease with which children and adults learn languages.
 - C.** Incorrect. Paragraph 4 does not claim that more is known about language learning in children; in fact, it says that children simply absorb language easily and does not attempt to explain how.
 - D. CORRECT.** Because adult brains lose the “innate language capability” of children and have less plasticity when it comes to language learning, the study chose to focus on adults and how exercise might help them learn new languages.
-
- 34.** The question asks how the first sentence from paragraph 6 functions in the overall structure of the excerpt.
- E.** Incorrect. While paragraph 6 begins to describe how the study was carried out, the results of the study have not yet been discussed in previous paragraphs.
 - F.** Incorrect. The population used for the study is an important detail that helps describe who participated in the study, as well as an ideal situation (college-age people trying to learn a new language), but this is not critical information used to determine the results.
 - G. CORRECT.** While paragraphs 4 and 5 address why the study focuses on adult language learning, the first sentence of paragraph 6 begins to give details about how the study was conducted, including describing the population being studied: “40 college-age Chinese men and women who were trying to learn English.”
 - H.** Incorrect. The sentence from paragraph 6 does not include examples or discuss questions for further research; it simply introduces the subjects recruited for the study.

- 35.** The question asks why the researchers in the excerpt asked the English learners to assess whether the new words made sense in the context of actual sentences.
- A. CORRECT.** As stated in paragraph 11, “Most linguists feel that understanding sentences shows greater mastery of a new language” than mere memorization of new words, so the researchers realized that asking learners to assess words in context would be a better measure of how well they learned the new words.
 - B.** Incorrect. The excerpt never addresses how earlier research on adult language learners was conducted.
 - C.** Incorrect. Having learners respond to the new words in context was used not as a teaching tool but rather to assess learners’ mastery (paragraph 11).
 - D.** Incorrect. The excerpt describes how proficiency at assessing words in context began to emerge “after several weeks of instruction” (paragraph 14) and never suggests that the task became more difficult after an extended period of time.
-
- 36.** The question asks which evidence from the excerpt is **most** relevant to the author’s claim that there are many unanswered questions about the relationship between movement and learning.
- E. CORRECT.** While the study revealed that the college students who used exercise bikes did better in their language learning, paragraph 18 indicates that we cannot know “whether other people completing other types of exercise would achieve the same results,” suggesting that there are many unknowns about the relationship between movement and learning.
 - F.** Incorrect. Rather than supporting the claim that there are many unanswered questions about the relationship between movement and learning, this statement offers a possible explanation as to why exercise might help learning.
 - G.** Incorrect. The finding that exercise helps people retain their language learning longer (paragraph 15) adds to our understanding of the relationship between movement and learning rather than supporting the claim that there are still many unanswered questions.
 - H.** Incorrect. Dr. Sulpizio’s statement that the study suggests that “ ‘instruction should be flanked by physical activity’ ” (paragraph 21) does not in any way address the issue of unanswered questions about movement and learning.

- 37.** The question asks which sentence from the excerpt **best** supports Dr. Sulpizio’s assertion in paragraph 17 that exercise went beyond helping with memorization to deepen the language learners’ ability to use new vocabulary.
- A.** Incorrect. This sentence merely describes what the language-learning sessions were like without making any claims about how the exercise affected the subjects’ understanding of how to use new words.
 - B.** Incorrect. While this sentence does address the fact that learners were required to think about how the new words should be used rather than just memorizing the words, it does not discuss results such as how the exercise affected their ability to do this.
 - C.** Incorrect. This sentence establishes only that exercise helped with the memorization of new words, not that exercise deepened learners’ grasp of how to use the new words.
 - D. CORRECT.** The fact that learners who exercised were better at identifying when the new words were used correctly in sentences directly supports Dr. Sulpizio’s assertion that the exercise deepened their grasp of how to use the new words.
-
- 38.** The question asks what paragraph 18 reveals about the author’s perspective toward the study in the excerpt.
- E. CORRECT.** As paragraph 18 says, the study cannot address “whether other people completing other types of exercise would achieve the same results” as college students riding bikes.
 - F.** Incorrect. While paragraph 18 mentions that the students performed “relatively light exercise,” it never suggests that more rigorous exercise should have been studied, only that it is still unknown what the impact on language learning would be for other populations doing other types of exercise.
 - G.** Incorrect. Paragraph 18 points out only that the study’s results cannot be generalized to other populations performing other types of exercise and never speculates on whether the study’s results could be duplicated.
 - H.** Incorrect. Far from claiming that the study’s results could be applied more broadly to learning in general, paragraph 18 points out the ways in which the study’s results cannot be applied more broadly.

39. The question asks for the **best** summary of the research procedure used in the study in the excerpt.
- A. Incorrect. This summary says that students learned new words by matching words and images and “also by analyzing words in context,” but this last method was how the researchers assessed students, not how the students learned words; the summary is therefore inaccurate.
 - B. **CORRECT.** The summary includes the most important information, which is that one group of non-English-speaking students exercised before and during the English lessons, while the other group did not, and that the students’ learning was assessed afterward.
 - C. Incorrect. This summary is incomplete because it never mentions the control group—that is, the students who studied English without exercising—which was essential to the study so that results could be compared.
 - D. Incorrect. This summary includes unnecessary details, such as that students were assessed after a short break and also assessed after a month of no studying; it also neglects to mention important points: that one group exercised both before and during learning, while the other group did not exercise at all.

Looking for the Smallest Spark in Everything

- 40.** The question asks what lines 5–8 reveal about the speaker to help develop a central idea of the poem.
- E.** Incorrect. In lines 5–8, the speaker is demonstrating knowledge about the structure of matter, not demonstrating interest in how matter’s parts work together; for example, “beneath the level of molecules are atoms, / and beneath the level of atoms, we find / protons, electrons, neutrons” (lines 5–7).
 - F. CORRECT.** Lines 5–8 show the connection between the particles by using the words “beneath the level” repeatedly. The progression of particles of matter, from atoms to subatomic particles, “protons, electrons, neutrons” (line 7), ends with a question. By asking, “what, exactly?” (line 8), the speaker questions the mysteries that are still unsolved about the nature of matter, which is a central idea of the poem.
 - G.** Incorrect. The speaker expresses curiosity in line 8 (“what, exactly?”) but does not use language in lines 5–8 that expresses a desire to prove a point. The poem does not show any conflict, either from within or from other scientists, about the concept that particles make up matter.
 - H.** Incorrect. While the poem is about the Large Hadron Collider, which, according to the introductory text before the poem, is a tool that “helps scientists study and understand how the smallest particles of matter interact with one another,” lines 5–8 do not suggest the use of tools but rather question what comes after the “protons, electrons, neutrons” (line 7).

- 41.** The question asks how the break between the second stanza (lines 5–14) and the third stanza (lines 15–26) serves as a transition between ideas.
- A. CORRECT.** The second stanza describes physical objects, including “your fingernail, / the candy at the back of your mouth, / the coffee your teacher drank this morning” (lines 9–11) and even “the stuffed dog” that “your little sister” (line 12) carries around. In the third stanza, the speaker introduces the topic of observation by asking, “How do we find it?” in line 17. Lines 17–18 offer one possible method for finding “it” (“We can listen for it / in the wavelengths from deep space”), while lines 20–22 describe a second method (“Or we can build long, / deep circular tunnels beneath the surface / of this Earth and race particles”). With these details, the focus of the poem shifts toward explaining how the particles that make up everything are observed.
 - B.** Incorrect. While the speaker does list common items such as “candy” and “coffee” (lines 10–11) that many people are familiar with and that seem to be simple in composition or structure, the speaker does not imply in the third stanza that invisible objects complicate the world. In fact, the speaker claims that everything is “made up of the same stuff” (line 16), which simplifies the invisible world.
 - C.** Incorrect. The second stanza focuses on the structure of matter (“beneath the level of molecules are atoms, / and beneath the level of atoms, we find / protons, electrons, neutrons” [lines 5–7]) and does not discuss the methods used to explore this structure in space. The third stanza mentions space (“We can listen for it / in the wavelengths from deep space” [lines 17–18]) and how we can “race particles” (line 22) on Earth but does not compare the methods of study used in these different locations.
 - D.** Incorrect. While the second stanza describes items that are familiar to readers, including “your fingernail, / the candy at the back of your mouth, / the coffee your teacher drank this morning” (lines 9–11), the familiarity of these items does not necessarily mean they are part of a comfortable environment. The third stanza discusses studying the parts of matter “until everything we think we know / bangs against everything else we know” (lines 25–26). The “banging” the speaker refers to is not related to an unstable environment but rather to the mysteries of atomic structure.
-

- 42.** The question asks what the comparison in lines 23–24 of the poem is mainly meant to show.
- E.** Incorrect. While the particles are moving “close to the speed of light” (line 24), which would make them difficult to see, the comparison in lines 23–24 focuses on the movement of the particles, not how visible they are.
 - F. CORRECT.** Lines 23–24 describe “tiny cars / flashing along at close to the speed of light,” which describes how the particles move.
 - G.** Incorrect. Lines 23–24 do not describe the shape of the particles but rather their movement, which is “flashing along at close to the speed of light” (line 24).
 - H.** Incorrect. The word “flashing” in line 24 does not refer to light in darkness but rather to speed, and the word “light” is used to reference a measurement of speed, not brightness in darkness.

43. The question asks how lines 25–26 help develop a central idea in the poem.
- A. Incorrect. Lines 25–26 illustrate the collision of old and new information about particles, but they do not describe “creative methods” that are currently being invented to research subatomic particles.
 - B. **CORRECT.** The lines “until everything we think we know / bangs against everything else we know” (lines 25–26) are about how the old knowledge about particles interacts with newfound knowledge.
 - C. Incorrect. While lines 20–22 describe the Large Hadron Collider as “long, / deep circular tunnels beneath the surface / of this Earth” where scientists “race particles,” lines 25–26 refer to the collision of old and new ideas about particles, not the limitations of the Large Hadron Collider.
 - D. Incorrect. Lines 25–26 focus on what “we think we know” about subatomic particles and how new discoveries challenge “everything else we know.” However, the challenge is not a result of scientists debating one another but rather what the Large Hadron Collider reveals about particles.
-
44. The question asks what the imagery in lines 27–28 reveals about the speaker.
- E. Incorrect. The physicists mentioned in the fifth stanza (lines 33–44) are described as mere observers: they “jot down / what they can” (lines 41–42). In lines 27–28, the speaker is focused on the reaction between the colliding particles, not on the physicists who study them.
 - F. Incorrect. The speaker describes the particle collision in detail, but the text does not imply that the speaker has personally witnessed a collision. The speaker implies that his or her understanding of the collision is based on the experiences of the physicists observing the phenomenon (“They spin, and it is only down there / in the darkness—in the vast garage / where physicists jot down / what they can, whatever seems most real— / that they let us perceive their wild dancing” [lines 39–43]).
 - G. **CORRECT.** The word “explosion” and the phrase “briefly incandescent” create a picture of rapid changes and short bursts of bright light, revealing how powerful the new particles are. The language the speaker uses is positive, revealing that the speaker admires the power of the reaction and stands in awe of the new particles.
 - H. Incorrect. The poem reveals the speaker’s deep knowledge about subatomic particles. For example, the speaker is able to name the new particles discovered—“the quarks, the leptons, and the bosons; / the baryons and the mesons” (lines 29–30)—and is able to use imagery to create a powerful picture that reveals the complexity of a scientific process that humans have never been able to see.

45. The question asks why the speaker refers to familiar objects and events in lines 30–32.
- A. Incorrect. In lines 30–32, the speaker only gives an opinion about what the names sound like and does not simplify confusing information about how these newly discovered particles function or exist.
 - B. Incorrect. In lines 30–32, the speaker is only describing what the names of the particles sound like: “dinosaurs or maybe bands” (line 31). These descriptions illustrate the speaker’s opinion but do not explain specific scientific ideas.
 - C. Incorrect. In lines 30–32, the mention of the names of the particles sounding like “dinosaurs or maybe bands” (line 31) reveals the speaker’s opinion about the names but does not explain the process of researching the particles.
 - D. **CORRECT.** The phrase “their names” (line 30) refers to the scientific names of the particles: “the quarks, the leptons, and the bosons; / the baryons and the mesons” (lines 29–30). In lines 30–32, the speaker expresses the opinion that these scientific terms sound nonsensical, much like the strange scientific names of dinosaurs or silly band names.
-

46. The question asks for the **most likely** reason the poet includes lines 36–39 in the poem.
- E. Incorrect. While the poem implies that the research is important, lines 36–39 do not point to a need for more research. Instead, the lines explain the power of the particles in the universe.
 - F. **CORRECT.** The particles that are “Everything and everywhere” (line 15) make up the objects mentioned in lines 36–39: a “pencil in your hand” and the planet “Jupiter.” Even though these objects are different from each other and extremely far apart in the universe, they are made up of and affected by these particles. The “powerful effect” is that the particles keep the objects “both together and apart” (line 36).
 - G. Incorrect. While the physicists can only “jot down / what they can, whatever seems most real” (lines 41–42), the discoveries about particles are ongoing and informative. The speaker shares that the particles are “everything and everywhere” (line 15) and that they “spin” (line 34) because “this is how gravity / enters our world” (lines 34–35).
 - H. Incorrect. The speaker states that particles keep together objects in space, such as Jupiter, as well as objects on Earth, such as “the pencil in your hand right now” (line 37). However, in lines 36–39, the speaker is not comparing the study of subatomic particles with the study of objects in space (astronomy); the speaker is implying that because particles are “everything and everywhere” (line 15), the study of particles affects our understanding of everything in the universe, regardless of location.

47. The question asks which central idea is emphasized in the last stanza (lines 33–44).
- A. **CORRECT.** Throughout the poem, the speaker describes how everything in our universe and in our everyday lives is made up of these tiny particles. The last stanza allows us to picture the scientists working “in the darkness” (line 40), jotting down notes. Phrases like “wild dancing” (line 43) and “combusting to the music” (line 44) describe the activity of the particles and communicate the idea that the findings are exciting.
 - B. Incorrect. While the Large Hadron Collider is in an unconventional location that is important in the poem, it is the only location described in the poem: “it is only down there / in the darkness—in the vast garage” (lines 39–40). While the darkness is a special condition, the poem does not describe other conditions where the same type of research is being carried out. The poem does mention that “we can listen for it / in the wavelengths from deep space, / talking back to us from unimaginable / distances” (lines 17–20), but this description implies the use of a tool (a satellite), not a location.
 - C. Incorrect. The last stanza states that “The one thing we know for sure / is that they spin” (lines 33–34). This detail is one aspect of the particles’ behavior that is known; therefore, the particles are not completely unpredictable. In addition, the poem never describes the particles breaking up matter in the universe; the poem describes only their movements and collisions.
 - D. Incorrect. While the “physicists jot down / what they can, whatever seems most real” (lines 41–42), the research they share with the world is complicated and difficult to understand, making it unlikely that their findings are relatable to most people.
-

48. The question asks what lines 39–44 reveal about the speaker.
- E. Incorrect. While the discoveries are made “in the darkness” (line 40), the imagery conveys the speaker’s positive tone through descriptions like “perceive their wild dancing” (line 43) and “combusting to the music they make” (line 44), not frustration.
 - F. Incorrect. In lines 39–44, the imagery of energetic movement (“They spin,” “their wild dancing,” and “combusting to the music they make”) is used to describe the particles, not the physicists.
 - G. **CORRECT.** The speaker uses the phrases “only down there” (line 39), “physicists jot down ... whatever seems most real” (lines 41–42), and “they let us perceive” (line 43) to convey that the physicists have a rare role in studying the mysteries of the universe and that the speaker appreciates and is interested in their work.
 - H. Incorrect. While the description of the experiments occurring “in the darkness” (line 40) may create a sense of secrecy, the secrets that the darkness refers to are the mysteries of subatomic particles, not the work processes that the physicists use.

Excerpt from "Impressions of an Indian Childhood"

49. The question asks how the phrases “cool morning breezes swept freely” and “wafting the perfume of sweet grasses” affect the tone of paragraph 1 in the excerpt.
- A. Incorrect. Although the author describes in paragraph 1 the setting of her childhood experiences, the positive wording of the phrases the author uses in the paragraph (“swept freely” and “perfume of sweet grasses”) does not suggest a tone of sadness the author feels when she reflects on her former way of life.
 - B. Incorrect. Although the phrases “cool morning breezes swept freely” and “wafting the perfume of sweet grasses” used in paragraph 1 create a positive tone, the phrases do not suggest an enthusiasm for the author’s work but rather an appreciation of the peaceful beauty of her childhood.
 - C. **CORRECT.** In paragraph 1, the phrases “cool morning breezes swept freely” and “wafting the perfume of sweet grasses” are used to describe where the author’s childhood experiences took place. The phrases create a tone of fondness and evoke a feeling of happiness through their lyrical sensory detail: “swept freely” suggests a sense of joyful possibility, while “perfume,” “sweet,” and “cool” convey delight.
 - D. Incorrect. Although the author describes her mother’s beadwork lessons as “confining” in paragraph 7, the phrases in paragraph 1 do not suggest that the author feels conflicting or mixed emotions toward her work and her mother. Instead, the phrases convey a positive tone by affectionately describing the author’s childhood home.
-
50. The question asks what the phrase “just as an artist arranges the paints upon his palette” in paragraph 2 suggests in the excerpt.
- E. **CORRECT.** In paragraph 2, by comparing the way her mother arranges the beads to the way a painter “arranges the paints upon his palette,” the author emphasizes that her mother approaches her craft just as a painter does, thus suggesting that beadwork is a true form of art.
 - F. Incorrect. Although the author mentions “bunches of colored beads” in paragraph 2, this detail does not provide enough evidence for the idea that color inspires beadworkers. The phrase “just as an artist arranges the paints upon his palette” indicates the connection of beadwork to other forms of art in general, not necessarily to the specifics of color as a source of inspiration.
 - G. Incorrect. In paragraph 2, the author describes her mother “untying the long tasseled strings” and then spreading “upon a mat beside her bunches of colored beads.” However, the phrase “just as an artist arranges the paints upon his palette” does not suggest that all artistic activities begin with a series of steps. There is no mention in the passage of any other artistic activities involving multiple initial steps.
 - H. Incorrect. In paragraph 2, the author describes how her mother “spread upon a mat beside her bunches of colored beads” as the first step in the artistic process described in the passage. Therefore, the comparison between the mother’s process and a painter arranging paints on a palette suggests that the mother is creating art, not imitating it. There is no indication that the mother is copying a technique she has seen in other art forms.

51. The question asks how the author’s use of sequence in paragraphs 1 and 2 contributes to the development of ideas in the excerpt.
- A. Incorrect. In paragraph 2, the author does list the steps her mother takes in preparation to do beadwork, such as “untying the long tasseled strings” of the bag of beads, spreading the beads beside her on a mat, and using “a long, narrow blade” to trim the buckskin into shape. However, the language used to describe this sequence does not indicate that preparing to work with beads is difficult or complex.
 - B. Incorrect. Although the author’s description of untying the bag of beads, spreading the beads upon a mat, smoothing out a sheet of buckskin, and trimming the buckskin into shape in paragraph 2 indicates that the mother follows a certain routine, it does not place any emphasis on working most efficiently by following the steps of the beading process in a precise order.
 - C. Incorrect. In paragraph 2, the author describes her mother “untying the long tasseled strings that bound a small brown buckskin bag,” “spread[ing them] upon a mat beside her bunches of colored beads,” “smooth[ing] out a double sheet of soft white buckskin; and drawing from a beaded case that hung on the left of her wide belt a long, narrow blade” to trim the buckskin. Although these descriptions do outline the steps in her process for creating beadwork, they do not emphasize the time required to do so, since the author does not mention in the excerpt how long it took her mother to fully prepare for and complete the large and small tasks in the activity of beading.
 - D. **CORRECT**. In paragraph 1, the author describes how the morning begins with her mother rolling up the canvas of the wigwam and allowing the breeze to come in. In paragraph 2, the author uses sensory language and precise sequencing to describe the way her mother prepares the beading materials by untying “the long tasseled strings that bound a small brown buckskin bag,” spreading the “bunches of colored beads” beside her, and smoothing out “a double sheet of soft white buckskin.” This combination of sequence and sensory language highlights the author’s enthusiasm for beadwork by emphasizing that the author pays close attention to her mother’s preparations.

- 52.** The question asks how the details in paragraph 3 convey a central idea of the excerpt.
- E.** Incorrect. In paragraph 2, the author mentions how her mother “worked upon small moccasins for her small daughter” and when she did, the author “became intensely interested in her [mother’s] designing.” However, in paragraph 3, the author is interested in her mother’s work mainly as part of her “lessons in the art of beadwork,” not because she knew her mother was making something for her.
 - F.** Incorrect. In paragraph 3, the author receives “practical observation lessons in the art of beadwork” and describes how “from a skein of finely twisted threads of silvery sinews my mother pulled out a single one” and “pierced the buckskin, and skillfully threaded it with the white sinew.” The author describes the process in such detail that she provides no indication that she had difficulty learning through observation. The author also does not give any indication in the paragraph that she wanted to help her mother; she was there merely to observe and learn.
 - G.** Incorrect. Although the author refers to her beading lessons with her mother as “practical observation lessons in the art of beadwork” and indicates that she sat “close beside” her mother while observing her beadwork, the author provides no indication in the paragraph that she was determined to behave according to her mother’s standards or that she sought her mother’s approval.
 - H. CORRECT.** In paragraph 3, the author describes her mother’s artistry and craftsmanship by using language such as “skillfully threaded,” “picking up the tiny beads one by one,” and “twisting it carefully after every stitch.” These close observations indicate that the author greatly admired her mother’s mastery of her craft and the precision that went into every detail of her work.

- 53.** The question asks which sentence **best** summarizes the process of beading that is described in the excerpt.
- A.** Incorrect. In paragraphs 2 and 3, the author describes how at the beginning of the process her mother “smoothed out a double sheet of soft white buckskin” on a lapboard (paragraph 2) and how she strings the beads into a pattern. However, this sentence does not describe the steps that take place between the preparation and the stringing of the beads. Thus, this sentence does not best summarize the beading process.
 - B.** Incorrect. In paragraphs 2 and 3, the author describes the process her mother uses to string the beads with “the point of her thread, always twisting it carefully after every stitch” (paragraph 3). While this sentence includes some of the steps in the beading process, it does not describe the preparation that must take place before beginning the task, namely spreading the beads and the buckskin out on a table. Thus, this sentence does not best summarize the beading process.
 - C. CORRECT.** This sentence best summarizes the process of beading that is described in the excerpt because it includes details about each step in the process. In paragraph 2, the author explains how her mother “spread upon a mat beside her bunches of colored beads” and how “on a lapboard she smoothed out a double sheet of soft white buckskin; and drawing from a beaded case that hung on the left of her wide belt a long, narrow blade, she trimmed the buckskin into shape.” The author continues her description in paragraph 3, stating, “From a skein of finely twisted threads of silvery sinews my mother pulled out a single one. With an awl she pierced the buckskin, and skillfully threaded it with the white sinew. Picking up the tiny beads one by one, she strung them with the point of her thread, always twisting it carefully after every stitch.”
 - D.** Incorrect. In paragraphs 2 and 3, the author describes the process her mother uses as she “smoothed out a double sheet of soft white buckskin” (paragraph 2) on a lapboard before stringing the beads. While this sentence includes most of the steps in the beading process, it excludes the step of piercing the buckskin. This sentence also provides few details about the process of beading and uses vague wording to describe each step. Therefore, the sentence does not best summarize the beading process.

54. The question asks how the idea that mastering moccasin design and creation requires experience is **best** illustrated in the excerpt.

- E. CORRECT.** In paragraph 6, the author states that when she became more familiar with elements of design, “a harder lesson was given me.” According to the author, sewing on porcupine quills is a much more difficult task to master because it requires experience in handling the poisonous porcupine quills, which is why her mother told her not to “do much alone in quills” until she was older (paragraph 6). This information best illustrates the idea that mastering moccasin design and creation requires experience.
- F.** Incorrect. Although the author provides detailed descriptions of the materials used to make decorated moccasins (“colored beads” [paragraph 2]; “a skein of finely twisted threads of silvery sinews” [paragraph 3]; “tinted porcupine quills, moistened and flattened between the nails of the thumb and forefinger” [paragraph 6]), these descriptions do not illustrate the experience that is needed to gain mastery of moccasin design and creation.
- G.** Incorrect. Although the author describes the color combinations she used in making moccasins (“I was pleased with an outline of yellow upon a background of dark blue, or a combination of red and myrtle-green. There was another of red with a bluish-gray that was more conventionally used” [paragraph 6]), this information mainly illustrates the author’s satisfaction with her moccasin design, not the importance of experience in mastering the creation and design of moccasins.
- H.** Incorrect. In paragraph 7, the author tells of using a sharpened rod to spear gum from trees. She explains that she and her playmates used the rods to “[pry] up certain sweet roots” to find the gum. The detail of the sharpened rod is from a recollection about the playtime that followed the “confining lessons” of moccasin making. However, the sharpened rod was not used to create moccasins.

- 55.** The question asks how the author distinguishes her point of view from that of her mother.
- A.** Incorrect. In paragraph 4, the author explains that “it took many trials before I learned how to knot my sinew thread on the point of my finger, as I saw her do” and that the “difficulty was in keeping my thread stiffly twisted, so that I could easily string my beads upon it.” Although this explanation describes the author’s difficulty in performing the same task as her mother, it does not distinguish her point of view from that of her mother. In fact, they seem to share the same point of view regarding the importance of the technique the author is attempting to learn.
 - B. CORRECT.** In paragraph 5, the author distinguishes her point of view from that of her mother by describing their approaches to beadwork design. In the paragraph, the author states, “I usually drew easy and simple crosses and squares” and that “my original designs were not always symmetrical nor sufficiently characteristic, two faults with which my mother had little patience.” The author also distinguishes her point of view from that of her mother by stating that “the quietness of [my mother’s] oversight made me feel strongly responsible and dependent upon my own judgment.”
 - C.** Incorrect. In paragraph 6, the author states, “My mother cut off the prickly ends and burned them at once in the centre fire. These sharp points were poisonous, and worked into the flesh wherever they lodged. For this reason, my mother said, I should not do much alone in quills until I was as tall as my cousin Warca-Ziwin.” Although these instructions explain the importance of having experience and skill when working with quills, they do not distinguish the author’s point of view from that of her mother.
 - D.** Incorrect. In paragraph 7, the author describes her beadwork lessons as “confining” and states that she liked to roam “over the hills” with her playmates after the lessons. However, she makes no mention of her mother in paragraph 7; the activities and ideas stated there belong to the author, not the mother.

- 56.** The question asks which sentence **best** describes how the sentence from paragraph 7 fits into the overall structure of the excerpt.
- E.** Incorrect. Though the author feels humiliated “when some boldness of mine drew forth a rebuke from” her mother (paragraph 5) and characterizes her lessons with her mother as “confining” (paragraph 7), the overall passage does not portray a demanding relationship between the author and the mother. The shift introduced in the sentence from paragraph 7 is not from one of the author’s relationships to another; it is from work to play.
- F.** Incorrect. In paragraph 6, the author explains how working with porcupine quills is difficult because the “sharp points were poisonous, and worked into the flesh wherever they lodged.” Although this sentence suggests that working with porcupine quills was challenging, the sentence from paragraph 7 does not signal a change from the challenging aspects of life on the reservation to the advantages of living on the prairie. Most of paragraph 6 describes the author’s pleasure in creating designs in different colors.
- G. CORRECT.** In the sentence from paragraph 7, the author refers to her beadwork lessons as “confining” and states that after the lessons, she “was wild with surplus spirits” and “found joyous relief” in being outside and running around. The phrases “surplus spirits” and “joyous relief” highlight a sense of freedom that stands in strong contrast to the “confining” nature of the author’s beadwork lessons, which required intense focus and control.
- H.** Incorrect. In paragraph 7, the author describes how “many a summer afternoon” after her beadwork lessons, she and her friends used “a light sharpened rod” to gather “sweet roots” and “little crystal drops of gum.” She then explains that they later “tossed away our gum, to return again to the sweet roots.” However, the sentence from paragraph 7 does not conclude the progression of events in the narrative by describing the sequence of events at the end of the author’s day; the sentence appears at the beginning of paragraph 7 and provides a contrast with events from the previous paragraph.

- 57.** The question asks how the table after paragraph 7 expands upon a central idea in the excerpt.
- A. CORRECT.** The table provides the chronology from the 1500s, when the Dakota created beadwork using “beads made from bones, shells, stones, and animal teeth,” to the 1830s, when the Dakota began “using glass beads,” and the 1900s, when they created items to “sell outside their community.” Thus, the table helps expand on a central idea by showing that the craft the author was learning is a tradition that has endured through many generations.
 - B.** Incorrect. Although the table shows that the Dakota used “beads made from bones, shells, stones, and animal teeth” in the 1500s and that by the 1830s began “using glass beads in clothing, artwork, and decorations in place of Native-made beads,” it does not provide any information about the type of materials used by the author’s family.
 - C.** Incorrect. While the information included in the table states that “European traders [brought] glass beads to North America” in the 1500s and that by the 1920s the Dakota created “items to sell outside their community,” there is no mention of whether the uniqueness of Dakota beadwork was recognized in Europe.
 - D.** Incorrect. The table indicates that by the late 1600s the Dakota began trading with French traders from Europe who brought glass beads to the Americas and that by 1830 the Dakota were “using glass beads in clothing, artwork, and decorations in place of Native-made beads.” However, the table provides no information about whether this work incorporated color. Therefore, the table does not show that the author was able to incorporate color into her craftwork as a result of trade with other peoples.

- 58. (5,184)** First, find the volume of the cube using the formula $V = lwh$.

The length, width, and height of the cube are equal (18 mm).

$$V_c = 18 \times 18 \times 18 = 5,832 \text{ cubic mm}$$

Next, find the volume of the cut-out square prism, with equal length and width (6 mm), and height of 18 mm.

$$V_p = 6 \times 6 \times 18 = 648 \text{ cubic mm}$$

Finally, subtract the volume of the prism from the volume of the cube.

$$5,832 - 648 = 5,184 \text{ cubic mm}$$

- 59. (0.5)** To find p , the constant of proportionality of ounces of raisins, y , to cups of oatmeal, x , use the equation $y = px$.

The table shows that there is 1 ounce of raisins for 2 cups of oatmeal.

$$\begin{aligned} 1 &= 2p \\ \frac{1}{2} &= \frac{2p}{2} \\ 0.5 &= p \end{aligned}$$

The constant of proportionality is 0.5.

-
- 60. (4.6)** Subtract the number of grams of sugar Kelly used in her coffee from the original amount she had.

$$7.3 - 2.7 = 4.6 \text{ grams left}$$

-
- 61. (8)** The price of a book before tax is x and after tax is $1.08x$. Subtract to determine the tax rate.

$1.08x - x = 0.08x$, so the tax rate is 0.08.

The tax rate $m\%$ can be written as $\frac{m}{100}$.

Solve for m :

$$\frac{m}{100} = 0.08$$

$$100\left(\frac{m}{100}\right) = 100(0.08)$$

$$m = 8$$

-
- 62. (5)** The probability that any 1 seat will be selected at random from 20 seats is 1 out of 20. To find the probability as a percentage, convert the fraction to a decimal.

$$\frac{1}{20} = 0.05$$

Then convert the decimal to a percentage by multiplying by 100.

$$0.05 \times 100 = 5$$

The probability is 5%.

- 63. (B)** By observation, 3,575 ends in 75; therefore, 3,575 is divisible by 25.

$$3,575 \div 25 = 143$$

Test 143 for factors and eliminate 3, 5, and 7, but 11 is a factor.

$143 \div 11 = 13$; both 11 and 13 are prime numbers.

The first factor, 25, is not prime but is the product of primes, $5 \times 5 = 5^2$.

The prime factorization of 3,575 is $5^2 \times 11 \times 13$.

- 64. (H)** The goal is to isolate the variable x by using inverse operations. First, multiply both sides by 5 and then subtract $2y$ from both sides.

$$\frac{x + 2y}{5} = 3y$$

$$x + 2y = 15y$$

$$x = 13y$$

Another approach is to make the right side of the equation a fraction and then use cross multiplication for the first step.

$$\frac{x + 2y}{5} = \frac{3y}{1}$$

$$x + 2y = 15y$$

$$x = 13y$$

- 65. (D)** First, multiply both sides of the equation by 10 to eliminate the fractions. In other words, multiply each term by 10.

$$\frac{x}{10} + \frac{y - x}{5} = \frac{z}{10}$$

$$10\left(\frac{x}{10} + \frac{y - x}{5}\right) = 10\left(\frac{z}{10}\right)$$

$$\frac{10x}{10} + \frac{10(y - x)}{5} = \frac{10z}{10}$$

$$x + 2(y - x) = z$$

Then, distribute and combine like terms to find the value for z .

$$x + 2(y - x) = z$$

$$x + 2y - 2x = z$$

$$2y - x = z$$

- 66. (F)** First, find the sum for each set by adding the terms in each set separately.

The sum for set R is $5 + x + 3 + 8$, which is $x + 16$.

The sum for set S is $6 + y + 4 + 1$, which is $y + 11$.

The question states that these two sums are equal to each other, so write the equation and then rearrange using inverse operations.

$$x + 16 = y + 11$$

$$x = y - 5$$

$$x - y = -5$$

If the rearranging to obtain the target value is unclear, use the equation $x + 16 = y + 11$ and find a few possible values for x and y .

For example, if $x = 1$, then $y = 6$ because $1 + 16 = 6 + 11$. If $x = 2$, then $y = 7$ because $2 + 16 = 7 + 11$. Then find the value of $x - y$. No matter which values are chosen, $x - y$ will always be -5 .

- 67. (C)** The first step is to substitute the value for x into the expression to get $\frac{2}{2 - \frac{1}{4}}$. Then, evaluate the denominator and finally divide the numerator by the denominator.

$$\frac{2}{\left(\frac{7}{4}\right)} = 2 \div \left(\frac{7}{4}\right) = 2\left(\frac{4}{7}\right) = \frac{8}{7} = 1\frac{1}{7}$$

68. (F) Since the additional cost per pound is not added until the package weighs more than 3 pounds, the total cost for 1, 2, or 3 pounds is \$12.

- 1 pound is \$12
- 2 pounds is \$12
- 3 pounds is \$12

Since p is greater than or equal to 3 pounds, the total cost for:

- 4 pounds is

$$12 + (4 - 3)(2) = 14$$

- 5 pounds is

$$12 + (5 - 3)(2) = 16$$

- p pounds is

$$12 + (p - 3)(2) = 12 + 2(p - 3)$$

You may try to write the expression without generating the pattern by recognizing that subtracting 3 from the number of pounds for the package before multiplying by \$2 and then adding \$12 results in the total cost.

69. (C) The question uses the phrase “no more than,” which translates to “less than or equal to” (\leq).

Since T-shirts cost \$9.25 each and Julie bought x T-shirts, the total cost just for the T-shirts is found by multiplying \$9.25 by x , or $9.25x$.

Combining the cost for one bag (\$18.75) plus the cost for x T-shirts, the inequality is $18.75 + 9.25x \leq 50.00$.

- 70. (E)** Use inverse operations to isolate the variable x by first getting the x variable on one side.

$$2x + 11 > 3x + 9$$

$$2x - 3x + 11 > 3x - 3x + 9$$

$$-x + 11 > 9$$

$$-x + 11 - 11 > 9 - 11$$

$$-x > -2$$

Now, when dividing by -1 , the direction of the inequality sign changes.

$$-x > -2$$

$$x < 2$$

Another way to solve is to keep the coefficient of x positive and then recognizing that $2 > x$ is the same as $x < 2$.

$$2x + 11 > 3x + 9$$

$$11 > x + 9$$

$$2 > x$$

$$x < 2$$

- 71. (A)** To find the perimeter of a triangle, add the measures of the three sides. The perimeter of the scale drawing is $5 + 7 + 8 = 20$ inches.

Now, use the perimeters to find the scale factor for the scale drawing to the actual perimeter.

The scale factor is 20 inches to 25 miles, which reduces to a scale factor of 4 inches to 5 miles. Note that the scale for the perimeter is the same as the scale for the side lengths.

Since the smallest side on the scale drawing is 5 inches, use the scale factor to find the actual side length of the smallest side:

$$5 \text{ inches} \left(\frac{5 \text{ miles}}{4 \text{ inches}} \right) = 6.25 \text{ miles}$$

- 72. (H)** \overline{SP} represents the radius of the circle and has length 12.

Both \overline{RP} and \overline{PT} are radii and also have length 12.

Therefore, the length of \overline{RT} , which is a diameter, is 24 and is also represented by $x + 5$.

$$x + 5 = 24$$

$$x = 19$$

- 73. (A)** Since the three angles of a triangle have a sum of 180° , and since one angle is a right angle, the other two angles have a sum of 90° . By writing an equation and using inverse operations, the value of x can be found.

$$(2x + 9) + (3x - 14) = 90$$

$$5x - 5 = 90$$

$$5x = 95$$

$$x = 19$$

Now, use substitution to find the measure of the two angles to determine the smallest angle of the triangle.

$$2x + 9 = 2(19) + 9 = 47$$

$$3x - 14 = 3(19) - 14 = 43$$

The smallest angle is 43° .

- 74. (F)** Pages read in the morning:

$$\left(\frac{1}{4}\right)(84) = 21$$

Pages remaining after the morning:

$$84 - 21 = 63$$

Pages read in the afternoon:

$$\left(\frac{1}{3}\right)(63) = 21$$

Pages he still needs to read:

$$63 - 21 = 42$$

- 75. (C)** To add fractions, find a common denominator and rename the fractions using the common denominator. The least common denominator for 11, 22, and 33 is 66. After adding the fractions, the final fraction can be reduced to lowest terms.

$$\frac{1}{11} = \frac{1 \times 6}{11 \times 6} = \frac{6}{66}$$

$$\frac{1}{22} = \frac{1 \times 3}{22 \times 3} = \frac{3}{66}$$

$$\frac{1}{33} = \frac{1 \times 2}{33 \times 2} = \frac{2}{66}$$

$$\frac{6}{66} + \frac{3}{66} + \frac{2}{66} = \frac{11}{66} = \frac{1}{6}$$

- 76. (H)** First, add the number of students that are members of both orchestra and choir.

$$38 + 46 = 84$$

Then, subtract to find the number of students that are members of both orchestra and choir.

$$84 - 64 = 20$$

Then, find the fraction of the 64 students that are members of both orchestra and choir.

$$\frac{20}{64} = \frac{5}{16}$$

- 77. (C)** First, add the mixed numbers. Then, convert the fraction $\frac{1}{9}$ to a decimal.

$$1\frac{2}{3} + 2\frac{4}{9}$$

$$1\frac{6}{9} + 2\frac{4}{9}$$

$$3 + \frac{10}{9}$$

$$3 + 1\frac{1}{9}$$

$$4\frac{1}{9} = 4.111\dots = 4.\overline{1}$$

- 78. (G)** First, convert the decimal 0.4, which is read as four-tenths, to the fraction $\frac{4}{10}$, and then set up a proportion to solve for x using cross products.

$$\begin{aligned}\frac{4}{10} &= \frac{x}{25} \\ 10x &= 100 \\ x &= 10\end{aligned}$$

Or, reduce the fraction to $\frac{2}{5}$ before setting up the proportion and then use proportional reasoning.

$$\begin{aligned}\frac{4}{10} &= \frac{2}{5} \\ \frac{2 \times 5}{5 \times 5} &= \frac{10}{25}\end{aligned}$$

Therefore, $x = 10$.

- 79. (B)** Use the order of operations to evaluate the expression. It is important to recognize that the fraction bar is a grouping symbol and so the entire numerator should be evaluated first. Exponents are evaluated first.

$$\frac{-9(-4)^2 + 36(-4) + 304}{-4}$$

$$\frac{-9(16) + 36(-4) + 304}{-4}$$

Then multiplication, recognizing that the product of a negative factor and a positive factor is negative.

$$\frac{-9(16) + 36(-4) + 304}{-4}$$

$$\frac{-144 - 144 + 304}{-4}$$

Then addition and subtraction in order from left to right, recognizing the rules for adding and subtracting signed numbers.

$$\frac{-144 - 144 + 304}{-4}$$

$$\frac{-288 + 304}{-4} = \frac{16}{-4}$$

And finally the fraction can be evaluated by division, recognizing that the quotient of a positive and a negative number is negative. $\frac{16}{-4} = -4$

- 80. (G)** First, determine the total amount Maxie borrowed, in dollars:

$$7.75 + 11.00 + 4.50 = 23.25$$

Then use subtraction to determine the difference between the amount her grandmother gave her and the amount she borrowed:

$$25.00 - 23.25 = 1.75$$

The difference is positive, which means that Maxie will still have \$1.75 left from the amount her grandmother gave her.

- 81. (B)** When Seth picks strawberries, the value represents a positive number, and when he eats the strawberries, the value represents a negative number. Write an expression and then evaluate the expression, where the negative value is multiplied by 3 because he ate the same amount on 3 different days.

$$\begin{aligned} 2\frac{1}{2} + 4 + (3)\left(-\frac{3}{4}\right) \\ 2\frac{1}{2} + 4 - 2\frac{1}{4} \\ 6\frac{1}{2} - 2\frac{1}{4} \\ 6\frac{2}{4} - 2\frac{1}{4} \\ 4\frac{1}{4} \end{aligned}$$

If the multiplication is confusing, evaluate the expression below which represents the sum for the 5 days with each day listed separately.

$$\begin{aligned} 2\frac{1}{2} + 4 + \left(-\frac{3}{4}\right) + \left(-\frac{3}{4}\right) + \left(-\frac{3}{4}\right) \\ 4\frac{1}{4} \end{aligned}$$

- 82. (E)** When looking for a situation where quantities combine to make zero, find two values with the same absolute value where one value is positive and one value is negative.

In the situation in option A, receiving a gift of \$5 is represented by +5, and giving a friend \$5 is represented by -5. These values combine to equal zero because $+5 - 5 = 0$.

- 83. (D)** First, simplify the numerator and the denominator separately.

To simplify the numerator, multiply the last two fractions and then subtract from the first fraction.

$$\begin{aligned}\frac{2}{3} - \left(\frac{4}{5} \times \frac{1}{3}\right) \\ \frac{2}{3} - \frac{4}{15} \\ \frac{10}{15} - \frac{4}{15} \\ \frac{6}{15} = \frac{2}{5}\end{aligned}$$

To simplify the denominator, divide the last two fractions and then add to the first fraction.

$$\begin{aligned}\frac{5}{3} + \left(\frac{1}{4} \div \frac{3}{4}\right) \\ \frac{5}{3} + \left(\frac{1}{4} \times \frac{4}{3}\right) \\ \frac{5}{3} + \frac{1}{3} \\ \frac{5}{3} + \frac{1}{3} = \frac{6}{3} = 2\end{aligned}$$

Finally, divide the numerator by the denominator.

$$\frac{\frac{2}{5}}{2} = \frac{2}{5} \div 2 = \frac{2}{5} \times \frac{1}{2} = \frac{1}{5}$$

84. (F) To determine the number of kilometers in 1 minute, find the unit rate in kilometers per minute: $\frac{\frac{1}{8} \text{ kilometer}}{\frac{3}{4} \text{ minute}}$.

To evaluate the fraction, use the reciprocal when dividing to get $\frac{1}{6}$ kilometer per 1 minute.

$$\frac{1}{8} \div \frac{3}{4} = \frac{1}{8} \times \frac{4}{3} = \frac{4}{24} = \frac{1}{6}$$

85. (B) First, find the length of the bus trip in miles by multiplying the time, 9 hours, by the average (mean) speed, 50 miles per hour, to get 450 miles.

Then, divide the total distance, 450 miles, by the average (mean) speed, 45 miles per hour, to get the total time:

$$450 \div 45 = 10 \text{ hours}$$

86. (F) First, calculate the amount of sunflower seeds in 25 pounds of this birdseed by using ratio reasoning to find that there are 10 pounds of sunflower seeds in the birdseed.

$$\frac{2}{5} = \frac{10}{25}$$

Then, use ratio reasoning to find the cost of the sunflower seeds per pound.

$$\left(\frac{\$0.10}{1 \text{ ounce}}\right)\left(\frac{16 \text{ ounces}}{1 \text{ pound}}\right) = \$1.60$$

The cost of the sunflower seeds is \$1.60 per pound.

Finally, find the total cost using ratios by multiplying the unit cost per pound by 10 pounds.

$$\frac{\$1.60}{1 \text{ pound}} \times \frac{10 \text{ pounds}}{1} = \$16.00$$

The first two steps above could be done in the other order; that is, find \$1.60 per pound first and 10 pounds of sunflower seeds second.

- 87. (A)** First, convert steps per second to steps per minute.

$$\frac{9 \text{ steps}}{6 \text{ seconds}} = \frac{90 \text{ steps}}{60 \text{ seconds}} = \frac{90 \text{ steps}}{1 \text{ minute}}$$

Then, use ratio reasoning to determine that each step must be 3 feet since 90 times 3 is 270 (or 270 divided by 90 is 3).

$$\frac{90 \text{ steps}}{1 \text{ minute}} \times \frac{3 \text{ feet}}{1 \text{ step}} = \frac{270 \text{ feet}}{1 \text{ minute}}$$

or

$$\begin{aligned} \frac{270 \text{ feet}}{1 \text{ minute}} \div \frac{90 \text{ steps}}{1 \text{ minute}} &= \\ \frac{270 \text{ feet}}{1 \text{ minute}} \times \frac{1 \text{ minute}}{90 \text{ steps}} &= \\ \frac{3 \text{ feet}}{1 \text{ step}} & \end{aligned}$$

- 88. (F)** Since 36 people each drank 2 cups of juice, the total amount of juice they drank was $36 \times 2 = 72$ cups.

Convert 72 cups to gallons:

$$\begin{aligned} 72 \text{ cups} \times \frac{1 \text{ quart}}{4 \text{ cups}} \times \frac{1 \text{ gallon}}{4 \text{ quarts}} &= \\ \frac{72}{16} \text{ gallons} &= \\ \frac{9}{2} \text{ gallons} &= \\ 4\frac{1}{2} \text{ gallons} & \end{aligned}$$

- 89. (B)** To find the fraction of the book the student can read in 1 hour, find the unit rate per hour. First, set up the ratio.

$$\frac{\frac{1}{12} \text{ book}}{\frac{1}{3} \text{ hour}}$$

Then use division to find the unit rate.

$$\frac{\frac{1}{12}}{\frac{1}{3}} = \frac{1}{12} \div \frac{1}{3} = \frac{1}{12} \times \frac{3}{1} = \frac{3}{12} = \frac{1}{4}$$

Another way to solve the problem is to set up the ratio and then multiply both the numerator and denominator by 3, since $\frac{1}{3}$ hour times 3 equals 1 hour.

$$\frac{3 \times \frac{1}{12} \text{ book}}{3 \times \frac{1}{3} \text{ hour}} = \frac{\frac{1}{4} \text{ book}}{1 \text{ hour}}$$

- 90. (G)** First, set up the ratio of the perimeter of the square to the triangle as 2:1 because the question states that the perimeter of the square is twice the perimeter of the triangle.

Recognizing that the square has 4 equal sides and that an equilateral triangle has 3 sides, use division to find the ratio of the sides.

$$\text{Perimeter: } 2:1 = \frac{2}{1}$$

$$\frac{\frac{2}{4}}{\frac{1}{3}} = \frac{2}{4} \div \frac{1}{3} =$$

$$\text{Sides: } \frac{2}{4} \times \frac{3}{1} = \frac{6}{4} =$$

$$\frac{3}{2} = 3:2$$

- 91. (A)** To find the cups of sugar for each cup of flour, find the unit rate using this ratio:

$$\frac{\frac{2}{3} \text{ cup of sugar}}{1\frac{1}{4} \text{ cups of flour}}$$

Then, convert the denominator to an improper fraction and divide to find the cups of sugar per cup of flour.

$$\frac{\frac{2}{3}}{\frac{5}{4}} = \frac{2}{3} \div \frac{5}{4} = \frac{2}{3} \times \frac{4}{5} = \frac{8}{15}$$

- 92. (F)** First determine the pages read for each assignment. Since the pages per assignment are inclusive, subtract the first page from the last page assigned and then add 1 to determine the pages read for each assignment.

$$\text{Assignment I: } (17 - 3) + 1 = 15$$

$$\text{Assignment II: } (38 - 25) + 1 = 14$$

$$\text{Assignment III: } (60 - 45) + 1 = 16$$

The student was assigned a total of 45 pages, since $15 + 14 + 16 = 45$.

To determine the percent, express 45 pages out of 250 pages as a fraction.

$$\frac{45}{250} = \frac{45 \div 5}{250 \div 5} = \frac{9}{50}$$
$$\frac{9}{50} = \frac{18}{100} = 18\%$$

-
- 93. (C)** In this context, the phrase “this sample is representative” means that the ratio of 2 red marbles to 8 green marbles is the same as the ratio of red to green marbles in the entire box. Use this ratio of 2 to 8 to set up a proportion and solve, where x represents the number of green marbles in the box.

$$\begin{aligned}\frac{2}{8} &= \frac{100}{x} \\ 2x &= 800 \\ x &= 400\end{aligned}$$

- 94. (G)** First, find the sales tax. Then, add the sales tax to the cost of the car. Finally, subtract the down payment to find out how much she has left to pay.

$$\begin{aligned}(0.08)(24,000) &= 1,920 \\ \$24,000 + \$1,920 &= \$25,920 \\ \$25,920 - \$10,000 &= \$15,920\end{aligned}$$

- 95. (C)** Range is the difference between the largest and the smallest values in a given set of data. In this case, the highest temperature is 17 and the lowest temperature is -5 . Therefore, the range is $17 - (-5) = 17 + 5 = 22$.

- 96. (F)** Each (x, y) ordered pair represents y , the number of applicants that made x errors.

First, determine the points with x -values less than 3.

The point $(1, 4)$ means that 4 applicants made 1 error.

The point $(2, 7)$ means that 7 applicants made 2 errors.

Then, add the y -values to find the total applicants who made fewer than 3 errors.

$$4 + 7 = 11$$

- 97. (C)** Using the joint probability formula, find the product of the two independent events. The probability that Emily will ride the bus to school on any given morning is $\frac{3}{5}$. The probability that Emily will ride the bus to school on any given afternoon is $\frac{4}{5}$. Therefore, the probability that Emily will ride the bus in the morning and the afternoon is $\frac{3}{5} \times \frac{4}{5} = \frac{12}{25}$.

- 98. (G)** An organized list can be used to determine the number of groups of 3 people that include **only** 1 male.

Let the letters A, B, C, and D represent the females, and let the numbers 1 and 2 represent the males.

Then, create a list of all possible combinations of 3 people with **only** 1 male.

AB1, AB2, AC1, AC2, AD1, AD2

BC1, BC2, BD1, BD2

CD1, CD2

There are 12 possible groups with **only** 1 male.

- 99. (D)** To calculate the joint probability, you must first determine the probability of each independent event. The probability that a randomly selected person has a common cold is $\frac{1}{20}$. The probability that a person has a cold caused by V144 is $\frac{1}{200}$. The probability that a person has a cold and the cold is caused by the V144 virus is the product of those two probabilities, $\frac{1}{20} \times \frac{1}{200} = \frac{1}{4,000}$.

- 100. (F)** There are four possible outcomes for each spin of the spinner:

1, 2, 3, 4

The possible outcomes of two spins are:

11	12	13	14
21	22	23	24
31	32	33	34
41	42	43	44

Of the 16 possible outcomes, only 3 pairings have a product of 4: 14, 22, and 41.

Therefore, the probability that the two numbers resulting from two consecutive spins have a product of 4 is $\frac{3}{16}$.

101. (D) The sample space of a random experiment is the collection of all possible outcomes. For this experiment, R represents a red marble, G represents a green marble, and W represents a white marble.

Since two marbles are being drawn, the possible outcomes for the first marble drawn are R, G, W.

List the possible results for each initial outcome combined with the second choice of marble. For example, if the first marble and second marble are both red, the sample space will include RR (red, red).

RR, RG, RW

GR, GG, GW

WR, WG, WW

Since order does not matter in this selection, remove any pairing that presents a duplicate choice, such as RG and GR—only one of the two pairings will be included in the sample space. Those are removed and leave a sample space of:

RR, RG, RW, GG, GW, WW

102. (G) It is given that x -values on the graph represent the numbers of hours for which water was added to the tank, and the y -values represent the numbers of gallons of water added in x hours. In the ordered pair (3, 24), 3 represents an x -value and 24 represents a y -value.

Therefore, (3, 24) represents a data point for 24 gallons of water being added to the tank in a 3-hour period.

103. (C) To find the probability that any one of several mutually exclusive events occurs, use the addition rule, and add the probabilities of each event:

$$P(A \text{ or } B) = P(A) + P(B)$$

Using the data in the table, the probability that the team will score 3 or more goals in the next game is represented by

$$\begin{aligned} P(3) + P(4) + P(5) &= \\ 0.21 + 0.09 + 0.04 &= 0.34. \end{aligned}$$

104. (G) A constant of proportionality, k , is the constant value of the ratio between two proportional values. Two varying values are said to be in a relation of proportionality when either their ratio or their product yields a constant. In the graph shown, the proportional relationship between x and y is represented by:

$$k = \frac{y}{x}$$

Therefore, the constant of proportionality for the relationship on the graph is:

$$k = \frac{9}{3} = \frac{3}{1} = 3$$

105. (B) The constant of proportionality is the ratio of y (90) to x (3). $90 \div 3 = 30$. So the constant of proportionality is 30.

106. (G) A variation of -2.5% to $+2.5\%$ means that the thickness of the machine part can be from 2.5% less than the standard of 0.38 mm to 2.5% greater than 0.38 mm.

The least allowed measure is

$$0.38 - 0.025(0.38) = 0.3705.$$

The greatest allowed measure is

$$0.38 + 0.025(0.38) = 0.3895.$$

Therefore, the allowable range of thicknesses is 0.3705 mm to 0.3895 mm.

107. (C) Using the specified equation $p = 2.50 + 1.25c$, determine the number of cupcakes Samantha bought by substituting the total paid (\$22.50) for p , and solve the equation for the value of c , the number of cupcakes bought.

$$22.50 = 2.50 + 1.25c$$

$$22.50 - 2.50 = 1.25c$$

$$20.00 \div 1.25 = c$$

$$16 = c$$

108. (G) It is given that m represents the purchase cost.

$1m$ represents 100%. The amount the purchase cost was increased is represented by 55%.

Therefore, the selling price will be $(100\% + 55\%)m$.

$$155\% = \frac{155}{100} = 1.55$$

The selling price can be represented by the expression $1.55m$.

109. (B) Proportional relationships are relationships between two variables where their ratios are equivalent. The graph of a proportional relationship will always go through the point $(0, 0)$.

In the text of the problem, it is given that the farmer begins with 100 apples.

Therefore, the ordered pair $(0, 100)$ would be the point at which the graph of the relationship crosses the y -axis, not $(0, 0)$.

Additionally, in a proportional relationship, each pair of values represents the same ratio of $\frac{y}{x}$.

If the relationship were proportional, the ratio for the first two days $(1, 98)$ and $(2, 96)$ would be equivalent.

$$\frac{98 \text{ apples}}{1 \text{ day}} = \frac{96 \text{ apples}}{2 \text{ days}}$$

$$2(98) \neq 96$$

- 110. (E)** Based on the diagram, the figure shown is a right rectangular prism with a square base. A horizontal slice of the figure will be a plane parallel to the square base, as in this example.

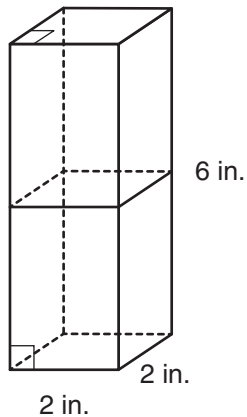

Since the horizontal slice is parallel to the base, it will be congruent to the base, which is a square with 2-inch sides.

- 111. (C)** Given that each piece will be a square, the length and width will be the same. The greatest possible length can be determined by finding the greatest common factor of the length and width of the original piece of cloth.

Begin by finding the prime factorization of the length (75 in.) and width (45 in.).

$$45 = 3 \times 3 \times 5$$

$$75 = 3 \times 5 \times 5$$

The common factors can be seen as 3×5 .

The greatest possible side length, in inches, will be $3 \times 5 = 15$.

112. (F) To determine the percent decrease from Monday to Tuesday, first calculate the decrease in the number of birds at the feeder.

$$30 - 24 = 6$$

The difference in the number of birds at the feeder divided by the number of birds on Monday will yield the percent decrease from Monday to Tuesday.

$$\frac{6}{30} = 0.20$$

0.20 represents 20%.

There was a 20% decrease from Monday to Tuesday.

113. (D) Since each can is worth 5 points, the total number of points earned from all the cans, x , is $5x$. The team started with 53 points. That is a constant value and doesn't change. So the total number of points the team will earn is $53 + 5x$. The team wants to earn at least (\geq) 100 points, so they need $53 + 5x \geq 100$ total points.

114. (G) Given a purchase price of \$456.00, the 125% increase in price is calculated as:

$$456 \times 1.25 = 570$$

The selling price equals the purchase price plus the increase, or:

$$456 + 570 = 1,026$$

The sales tax on the selling price is:

$$1,026(0.08) = 82.08$$

The customer pays the selling price plus the sales tax:

$$1,026 + 82.08 = 1,108.08$$

You can read explanations for each answer online here. If you are in 9th grade, you can find examples of additional types of math topics you might see on your test, here.

Answer Key for Sample Form B

1. D	14. G	27. B	40. F	53. C	66. F	79. B	92. F	105. B
2. G	15. D	28. G	41. A	54. E	67. C	80. G	93. C	106. G
3. D	16. F	29. B	42. F	55. B	68. F	81. B	94. G	107. C
4. F	17. B	30. H	43. B	56. G	69. C	82. E	95. C	108. G
5. C	18. F	31. A	44. G	57. A	70. E	83. D	96. F	109. B
6. F	19. D	32. E	45. D	58. 5184	71. A	84. F	97. C	110. E
7. D	20. H	33. D	46. F	59. 0.5	72. H	85. B	98. G	111. C
8. H	21. B	34. G	47. A	60. 4.6	73. A	86. F	99. D	112. F
9. C	22. G	35. A	48. G	61. 8	74. F	87. A	100. F	113. D
10. F	23. C	36. E	49. C	62. 5	75. C	88. F	101. D	114. G
11. A	24. E	37. D	50. E	63. B	76. H	89. B	102. G	
12. E	25. D	38. E	51. D	64. H	77. C	90. G	103. C	
13. C	26. G	39. B	52. H	65. D	78. G	91. A	104. G	

GRADE 9 MATHEMATICS SAMPLE QUESTIONS

Blank grids are provided on page 292.

1. $0.44 = \frac{x}{25}$

What is the value of x in the equation?

2. The two equations $y = 6x - 5$ and $y = -3x + 7$ are represented as lines on a graph. What is the y -value of the point of intersection of the two lines?
-

3. The function $y = 2x - 4$ is graphed. The line of the graph travels through point $(0, -4)$ and point $(12, y)$. What is the value of y in point $(12, y)$?
-

4. Which number has a value that is located between 7 and 8 on a number line?

- E. $\sqrt{37}$
- F. $\sqrt{47}$
- G. $\sqrt{57}$
- H. $\sqrt{67}$

5.

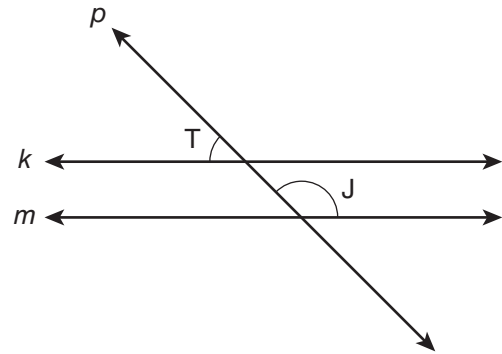

In the figure above, $k \parallel m$. Straight line p intersects both line k and line m . The measure of $\angle T$ is 47° . What is the measure of $\angle J$?

- A. 43°
 - B. 47°
 - C. 133°
 - D. 137°
-

6. Which of these numbers is irrational?

- E. $0.\overline{7}$
- F. $\sqrt{9}$
- G. $\frac{9}{7}$
- H. $\sqrt{7}$

7. Triangles JKL and $J''K''L''$ are congruent triangles.

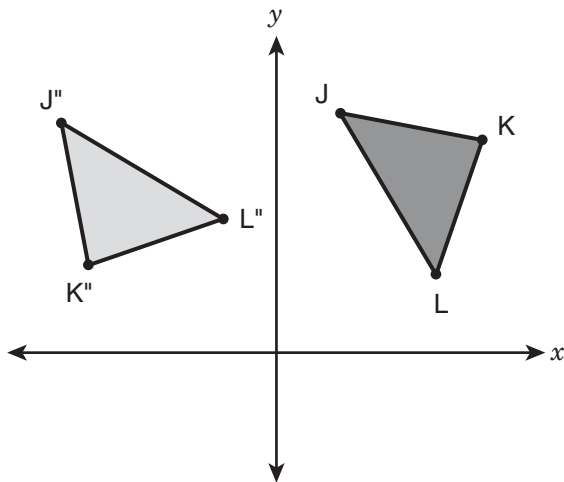

Which two transformations were used to transform JKL to $J''K''L''$?

- A. A translation to the right, and then a reflection across the y -axis
- B. A reflection across the x -axis, and then a clockwise rotation of 270°
- C. A rotation of 180° about the origin, and then a translation across the x -axis
- D. A reflection across the y -axis, and then a counterclockwise rotation of 90° about its center

8. The scatter plot shows a set of data.

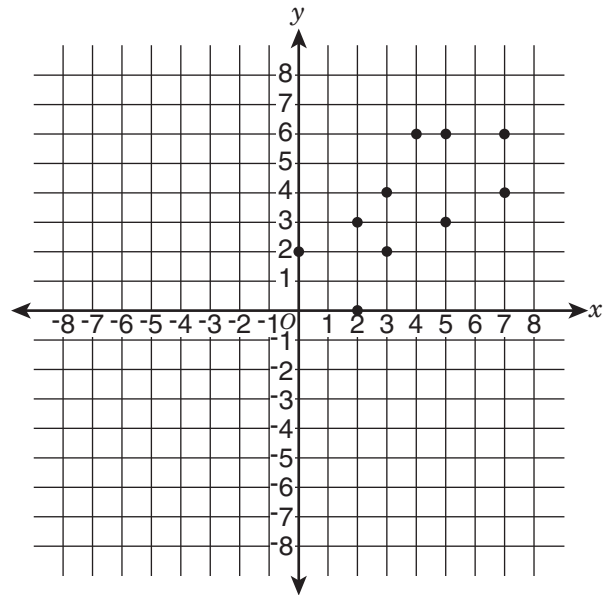

Which equation represents the most accurate line of best fit for the data shown in the scatter plot?

- E. $y = (-x)$
- F. $y = x$
- G. $y = (-x) + 2$
- H. $y = x + 2$

9. What is the point of intersection of the graphs of $y = -4x + 3$ and $y = 2x + 5$?

- A. $(-\frac{1}{3}, 4\frac{1}{3})$
B. $(-\frac{1}{3}, 5\frac{2}{3})$
C. $(\frac{1}{3}, 1\frac{2}{3})$
D. $(\frac{1}{3}, 5\frac{2}{3})$

10. The table below represents a linear function.

x	y
12	30
24	40
36	50

A second linear function is represented by the equation $y = 4x + 3$. Which statement comparing the rates of change of the two functions is true?

- E. The rate of change for $y = 4x + 3$ is less because $3 < 20$.
F. The rate of change for $y = 4x + 3$ is less because $-\frac{3}{4} > -24$.
G. The rate of change for $y = 4x + 3$ is greater because $4 > \frac{5}{6}$.
H. The rate of change for $y = 4x + 3$ is greater because $-\frac{3}{4} < \frac{5}{6}$.

11. How many solutions are there to the equation $|4x + 6| = -2$?
- A. No solutions
B. One solution
C. Two solutions
D. An infinite number of solutions

12. The scatter plot shows data that a researcher collected.

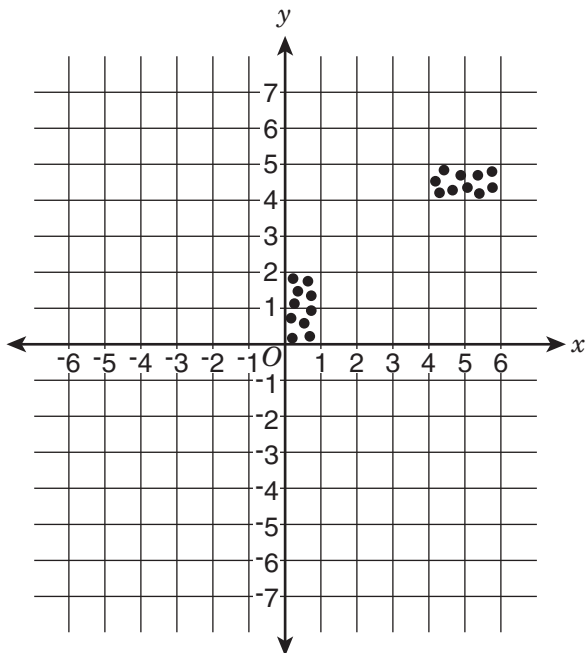

Which statement correctly describes the data?

- E. The data have a positive linear association.
- F. The data have a negative linear association.
- G. The data have clustering.
- H. The data have outliers.

- 13.

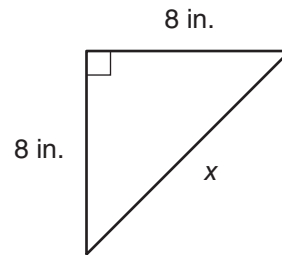

What is the length of x in the triangle?

- A. $\sqrt{89}$ in.
- B. $\sqrt{98}$ in.
- C. $\sqrt{128}$ in.
- D. $\sqrt{162}$ in.

1. **(11)** To determine the value of x , isolate x on one side of the equation:

$$0.44 = \frac{x}{25}$$

$$25(0.44) = \left(\frac{x}{25}\right)25$$

$$11 = x$$

2. **(3)** To determine the y -value of the point of intersection of the graphs of $y = 6x - 5$ and $y = -3x + 7$, first set the y -values equal:

$$6x - 5 = (-3x) + 7$$

$$9x - 5 = 7$$

$$9x = 12$$

$$x = \frac{4}{3}$$

Substitute the x -value of $\frac{4}{3}$ into either of the given equations to determine the value of y :

$$y = 6\left(\frac{4}{3}\right) - 5 \text{ or } y = (-3)\left(\frac{4}{3}\right) + 7$$

Solve for y :

$$y = \left(\frac{24}{3}\right) - 5 = 8 - 5 = 3$$

or

$$y = \left(\frac{-12}{3}\right) + 7 = (-4) + 7 = 3$$

The value of y , 3, is the y -coordinate of the point of intersection.

-
3. **(20)** The function $y = 2x - 4$ is linear because it is in the form $y = mx + b$.

Determine the value of y using the value of x from $(12, y)$, 12, in the equation of the function $y = 2x - 4$:

$$y = 2(12) - 4$$

$$y = 24 - 4$$

$$y = 20$$

4. **(G)** 57 is a number located between perfect squares 49 and 64. The value of $\sqrt{49}$ is located at 7 on a number line. The value of $\sqrt{64}$ is located at 8 on a number line. Therefore, the value of $\sqrt{57}$ is located between 7 and 8 on a number line.

5. **(C)** Angle T (47°) and the adjacent angle to its immediate right (x) are supplementary, so the sum of the two angle measures is 180° :

$$47^\circ + x = 180^\circ$$

$$x = 133^\circ$$

Because line k and line m are parallel and are both cut by line p , a transversal, corresponding angles are congruent. The 133° angle and angle J are corresponding angles, so the measure of angle J is 133° .

6. **(H)** $\sqrt{7}$ is an irrational number because it has a value of $\pm 2.645751311 \dots$, which is a non-repeating, non-terminating decimal, and non-repeating, non-terminating decimals are irrational numbers.

7. **(D)** First, reflect JKL over the y -axis to get $J'K'L'$, as seen by the reversed vertices.

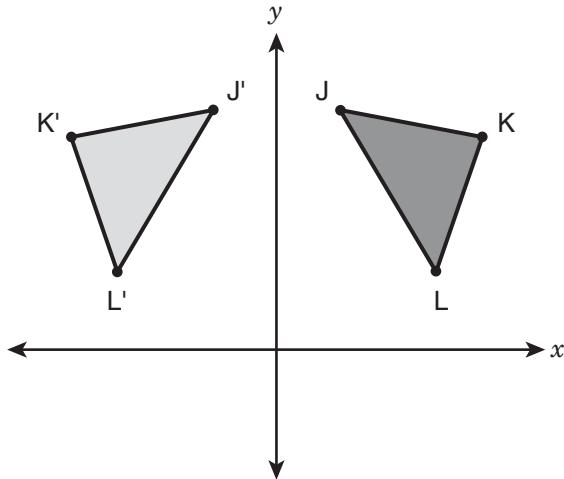

Then, rotate $J'K'L'$ 90° counterclockwise about the center, since the order of the vertices is still the same but rotated.

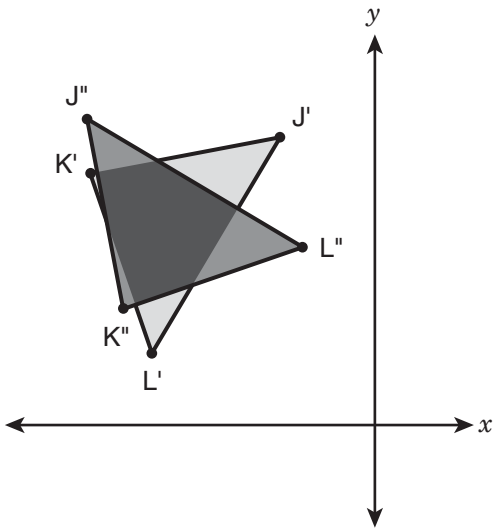

8. **(F)** The line $y = x$ has a positive slope. The data points shown on the scatter plot trend in a positive direction, and the location of $y = x$ results in 5 of the data points above the line and 5 of the data points below the line. This is the most accurate line of best fit for this data.

9. (A) To determine the point of intersection of the graphs of the lines, set the equations equal:

$$-4x + 3 = 2x + 5$$

Solve for x :

$$-6x = 2$$

$$x = \frac{2}{-6}$$

$$x = -\frac{1}{3}$$

This is the x -coordinate of the point of intersection. Use it to determine the

y -coordinate by substituting $\left(-\frac{1}{3}\right)$ for x in either of the equations:

$$y = 2\left(-\frac{1}{3}\right) + 5 \text{ or } y = -4\left(-\frac{1}{3}\right) + 3$$

Solve either equation for y :

$$y = \left(-\frac{2}{3}\right) + 5 = 4\frac{1}{3} \text{ or}$$

$$y = \frac{4}{3} + 3 = 4\frac{1}{3}$$

The x -coordinate of the point of intersection is the value of x $\left(-\frac{1}{3}\right)$ and the y -coordinate of the point of intersection is the value of y $\left(4\frac{1}{3}\right)$, making the point of intersection of the graphs of the two lines $\left(-\frac{1}{3}, 4\frac{1}{3}\right)$.

- 10. (G)** The rate of change is equal to the slope. Determine the rate of change for the linear function represented in the table:

$$\frac{y_2 - y_1}{x_2 - x_1} = \frac{(40 - 30)}{(24 - 12)} = \frac{10}{12} = \frac{5}{6}$$

The slope of a linear equation in the form $y = mx + b$ is the value of m , so the slope, or rate of change, of $y = 4x + 3$ is 4.

The rate of change of $y = 4x + 3$ is greater because $4 > \frac{5}{6}$.

- 11. (A)** No solutions are possible because an absolute value can never be negative.

- 12. (G)** The data have clustering because they form two distinct groups: one group (cluster) of data points is located in the area between (0, 0) and (1, 2), and the other group (cluster) of data points is located in the area between (4, 4) and (6, 5).

- 13. (C)** In a right triangle, the sum of the squares of the leg lengths is equal to the square of the length of the hypotenuse. In the given figure, the leg lengths are 8 in. and 8 in., and the hypotenuse is x .

Substitute the values into the equation

$$a^2 + b^2 = c^2:$$

$$(8)^2 + (8)^2 = x^2$$

$$64 + 64 = x^2$$

$$x^2 = 128$$

$$x = \sqrt{128}$$

Answer Key for Grade 9 Mathematics

1. 11	6. H	11. A
2. 3	7. D	12. G
3. 20	8. F	13. C
4. G	9. A	
5. C	10. G	

GRADE 8 GRID-IN SAMPLE PROBLEMS

DIRECTIONS: Solve each question. You can use the extra grid-in answer sheet on page 292 to record your answers. Print only one number or symbol in each box. Under each box, fill in the circle that matches the number or symbol you wrote above. **DO NOT FILL IN A CIRCLE UNDER AN UNUSED BOX. DO NOT LEAVE A BOX BLANK IN THE MIDDLE OF AN ANSWER.**

1. Carol's alterations company charges each customer \$5 per item plus \$3 for supplies. Carol charged a customer more than \$50. What is the minimum number of items Carol altered for the customer?
-

2. Point N is directly above point M. Point M is 8 feet below the ground, and point N is 40 feet above the ground. What is the distance, in feet, between the points?
-

3. What is the value of $-2.8 - (-1.2) + (-0.2)$?

4.

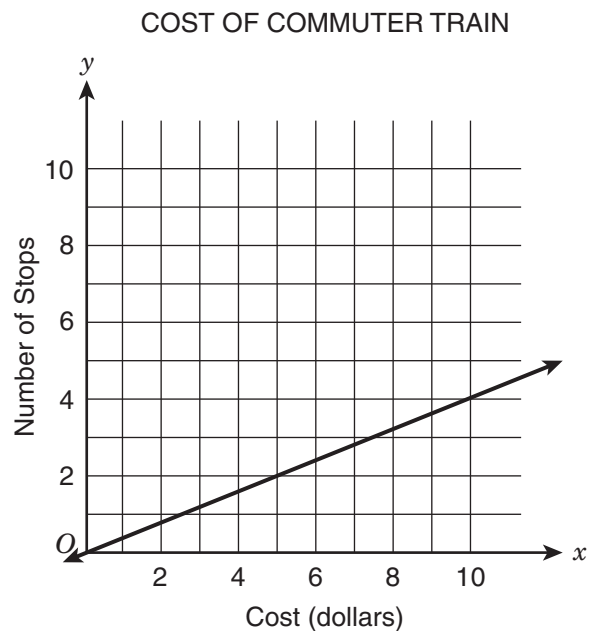

The graph shows the cost in dollars, x , for riding a commuter train through y stops. What is the rate of change for this relationship, expressed as a decimal?

5. The table shows a proportional relationship between the area of a floor and the number of tiles needed to cover the floor. What is the unit rate in tiles per square foot?

TILES NEEDED TO COVER FLOOR

Area of Floor (sq ft)	Number of Tiles Needed
80	520
130	845
220	1,430

6. A train that usually travels at an average speed of 45 miles per hour was scheduled to arrive in Bloomington in 8 hours. The train arrived 2 hours late. What was the average speed of the train, in miles per hour?

7.

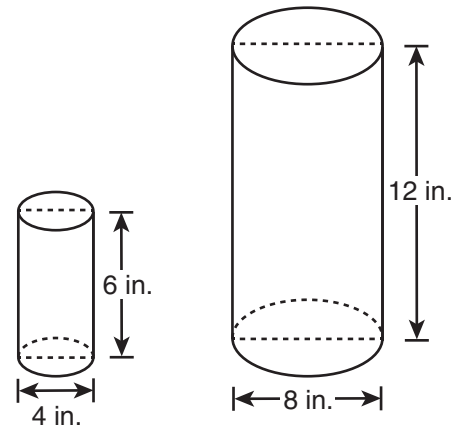

The figures above are cylinders. The smaller cylinder is completely filled with water. The larger cylinder is completely empty. If the water from the smaller cylinder is poured into the larger cylinder without any water being spilled, to what height, in inches, will the larger cylinder be filled?

- 8.** A deck of cards has red cards and blue cards. The probability of getting a red card in one draw is 0.70, and the probability of getting a blue card is 0.30. The tree diagram shows the possible outcomes of drawing one card, putting it back into the deck, and drawing a second card.

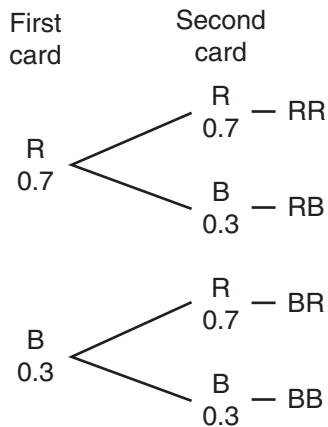

What is the probability of choosing a red card and blue card in two draws, in either order? Give your answer as a decimal.

- 9.** Enid and Susi are playing a math game on the computer. A correct answer of a math problem is worth +3 points, and an incorrect answer is worth $-2\frac{1}{2}$ points. Enid solves 7 problems correctly and 2 problems incorrectly. Susi solves 6 problems correctly and 5 problems incorrectly. How many more points does Enid have than Susi? Write your answer as a decimal.

- 10.** A basketball player makes 140 out of 200 free throws. The probability that the basketball player will make the next free throw is $x\%$. What is the value of x ?

1. **(10)** Let x represent the number of items that were altered. The charge for altering x items is $5x$ dollars. Carol charged a total, T , of $5x + 3$ dollars for altering x items.

Carol charged a total greater than \$50, $T > 50$. To find the number of items Carol altered, substitute $5x + 3$ for T in the inequality and solve for x .

$$5x + 3 > 50$$

$$5x > 47$$

$$x > 9.4$$

Carol altered at least 10 items.

	1	0		
-
0	●	0	0	
●	1	1	1	
2	2	2	2	
3	3	3	3	
4	4	4	4	
5	5	5	5	
6	6	6	6	
7	7	7	7	
8	8	8	8	
9	9	9	9	

2. **(48)** Given that point N is directly above point M, consider the distances as points on a number line.

The ground is represented by zero. Point M is 8 feet below the ground, or at -8 . Point N is 40 feet above the ground, or at $+40$.

The distance, in feet, between the two points is:

$$40 + |-8| = 48$$

	4	8		
-
0	0	0	0	
1	1	1	1	
2	2	2	2	
3	3	3	3	
●	4	4	4	
5	5	5	5	
6	6	6	6	
7	7	7	7	
8	●	8	8	
9	9	9	9	

3. **(-1.8)** The opposite of a negative number is positive. Rewrite the expression to show how $-(-1.2)$ becomes addition of a positive number:

$$\begin{aligned} & -2.8 + 1.2 + (-0.2) \\ & = -1.6 + (-0.2) \\ & = -1.8 \end{aligned}$$

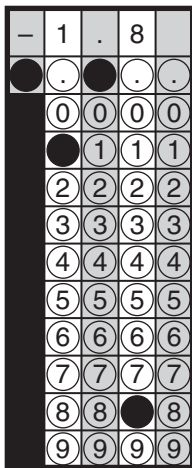

First, define the coordinates of two points on the graph: $(0, 0)$ and $(10, 4)$.

Substitute the x-values and y-values into the formula and solve for the rate of change.

$$\frac{4 - 0}{10 - 0} = \frac{4}{10} = 0.4$$

The rate of change is 0.4.

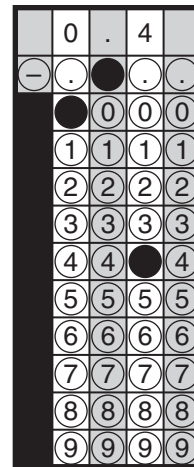

4. **(0.4)** The rate of change on a graph is the change in y divided by the change in x . The rate can be determined using the formula

$$\text{rate of change} = \frac{\text{change in } y}{\text{change in } x}$$

or

$$\text{rate of change} = \frac{y_2 - y_1}{x_2 - x_1}$$

5. **(6.5)** In a proportional relationship, the ratio between any pair of corresponding variables is equivalent—in this case, the ratio between the number of tiles needed to cover a floor and the area of the floor in square feet. To determine the unit rate in tiles per square foot, calculate the ratio of the number of tiles to the area in square feet. Since this relationship is specified to be proportional, calculating this ratio for any of the corresponding values in the table will yield the unit rate.

$$\frac{520}{80} = 6.5$$

$$\frac{845}{130} = 6.5$$

$$\frac{1,430}{220} = 6.5$$

The unit rate in tiles per square foot is 6.5.

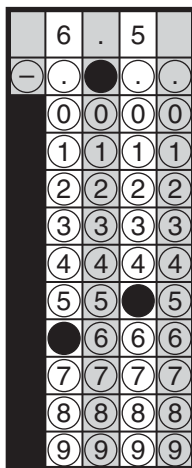

6. **(36)** Recall that
distance = rate \times time ($d = rt$).

First, calculate the distance the train traveled.

$$d = 45(8) = 360 \text{ miles}$$

If the train arrived 2 hours late, the time, t , would be $(8 + 2) = 10$ hours.

Substitute the distance, d , (360) and revised time, t , into the formula and then solve for r (rate, or average speed).

$$360 = r(10)$$

$$\frac{360}{10} = r$$

$$36 = r$$

The average speed of the train was 36 miles per hour.

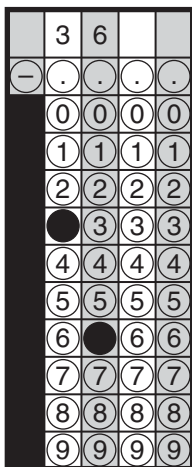

7. **(1.5)** The formula for the volume of a cylinder is $v = \pi r^2 h$. The diameter of the smaller cylinder is 4 inches, so the radius, r , is 2 inches.

$$v = \pi(2^2)(6)$$

$$v = \pi(4)(6)$$

$$v = 24\pi$$

The height, in inches, to which the water from the smaller cylinder will fill the larger cylinder can be determined by:

$$24\pi = \pi(4^2)h$$

$$24\pi = 16\pi h$$

$$\frac{24\pi}{16\pi} = h$$

$$1.5 = h$$

The water from the smaller cylinder will fill the larger cylinder to a height of 1.5 inches.

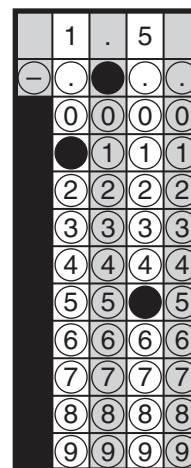

8. **(0.42)** The probability of drawing a red card is 0.70, and the probability of drawing a blue card is 0.30. Multiply the two probabilities to find the probability that a red card and then a blue card will be drawn: $0.70 \times 0.30 = 0.21$. Similarly, the probability of drawing a blue card and then a red card will be $0.30 \times 0.70 = 0.21$. The probability of either outcome is $0.21 + 0.21 = 0.42$.

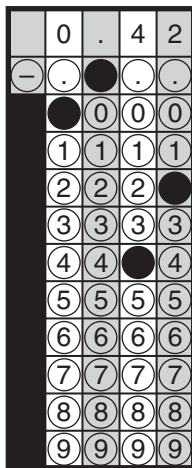

9. **(10.5)** Create an expression to represent the number of problems each student answered correctly, x , and the number each answered incorrectly, y .

$$\text{Enid: } 3x + \left(-2\frac{1}{2}\right)y$$

$$\text{Susi: } 3x + \left(-2\frac{1}{2}\right)y$$

Substitute the number of correct answers and incorrect answers for each student as stated in the problem. Then simplify each expression.

$$\text{Enid: } 3(7) + \left(-2\frac{1}{2}\right)(2)$$

$$= 21 + (-5)$$

$$= 16$$

$$\text{Susi: } 3(6) + \left(-2\frac{1}{2}\right)(5)$$

$$= 18 + (-12.5)$$

$$= 5.5$$

Last, determine how many more points Enid earned than Susi. $16 - 5.5 = 10.5$, so Enid earned 10.5 more points than Susi.

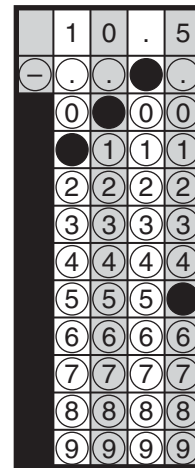

10. (70) Given that the player makes 140 out of 200 free throws, the probability that the player will make the next free throw ($x\%$) is $\frac{140}{200} = \frac{7}{10} = 0.70 = 70\%$. The value of x is 70.

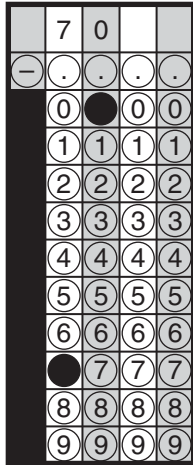

Test Booklet Letter

Test Booklet Number

Student's First Name (please print)

Student's Last Name (please print)

PART 1 ENGLISH LANGUAGE ARTS

- | | | | |
|--------------------|--------------------|--------------------|--------------------|
| 1 (A) (B) (C) (D) | 16 (E) (F) (G) (H) | 31 (A) (B) (C) (D) | 46 (E) (F) (G) (H) |
| 2 (E) (F) (G) (H) | 17 (A) (B) (C) (D) | 32 (E) (F) (G) (H) | 47 (A) (B) (C) (D) |
| 3 (A) (B) (C) (D) | 18 (E) (F) (G) (H) | 33 (A) (B) (C) (D) | 48 (E) (F) (G) (H) |
| 4 (E) (F) (G) (H) | 19 (A) (B) (C) (D) | 34 (E) (F) (G) (H) | 49 (A) (B) (C) (D) |
| 5 (A) (B) (C) (D) | 20 (E) (F) (G) (H) | 35 (A) (B) (C) (D) | 50 (E) (F) (G) (H) |
| 6 (E) (F) (G) (H) | 21 (A) (B) (C) (D) | 36 (E) (F) (G) (H) | 51 (A) (B) (C) (D) |
| 7 (A) (B) (C) (D) | 22 (E) (F) (G) (H) | 37 (A) (B) (C) (D) | 52 (E) (F) (G) (H) |
| 8 (E) (F) (G) (H) | 23 (A) (B) (C) (D) | 38 (E) (F) (G) (H) | 53 (A) (B) (C) (D) |
| 9 (A) (B) (C) (D) | 24 (E) (F) (G) (H) | 39 (A) (B) (C) (D) | 54 (E) (F) (G) (H) |
| 10 (E) (F) (G) (H) | 25 (A) (B) (C) (D) | 40 (E) (F) (G) (H) | 55 (A) (B) (C) (D) |
| 11 (A) (B) (C) (D) | 26 (E) (F) (G) (H) | 41 (A) (B) (C) (D) | 56 (E) (F) (G) (H) |
| 12 (E) (F) (G) (H) | 27 (A) (B) (C) (D) | 42 (E) (F) (G) (H) | 57 (A) (B) (C) (D) |
| 13 (A) (B) (C) (D) | 28 (E) (F) (G) (H) | 43 (A) (B) (C) (D) | |
| 14 (E) (F) (G) (H) | 29 (A) (B) (C) (D) | 44 (E) (F) (G) (H) | |
| 15 (A) (B) (C) (D) | 30 (E) (F) (G) (H) | 45 (A) (B) (C) (D) | |

PART 2 MATHEMATICS

58	59	60	61	62

- | | | | |
|--------------------|--------------------|---------------------|---------------------|
| 63 (A) (B) (C) (D) | 76 (E) (F) (G) (H) | 89 (A) (B) (C) (D) | 102 (E) (F) (G) (H) |
| 64 (E) (F) (G) (H) | 77 (A) (B) (C) (D) | 90 (E) (F) (G) (H) | 103 (A) (B) (C) (D) |
| 65 (A) (B) (C) (D) | 78 (E) (F) (G) (H) | 91 (A) (B) (C) (D) | 104 (E) (F) (G) (H) |
| 66 (E) (F) (G) (H) | 79 (A) (B) (C) (D) | 92 (E) (F) (G) (H) | 105 (A) (B) (C) (D) |
| 67 (A) (B) (C) (D) | 80 (E) (F) (G) (H) | 93 (A) (B) (C) (D) | 106 (E) (F) (G) (H) |
| 68 (E) (F) (G) (H) | 81 (A) (B) (C) (D) | 94 (E) (F) (G) (H) | 107 (A) (B) (C) (D) |
| 69 (A) (B) (C) (D) | 82 (E) (F) (G) (H) | 95 (A) (B) (C) (D) | 108 (E) (F) (G) (H) |
| 70 (E) (F) (G) (H) | 83 (A) (B) (C) (D) | 96 (E) (F) (G) (H) | 109 (A) (B) (C) (D) |
| 71 (A) (B) (C) (D) | 84 (E) (F) (G) (H) | 97 (A) (B) (C) (D) | 110 (E) (F) (G) (H) |
| 72 (E) (F) (G) (H) | 85 (A) (B) (C) (D) | 98 (E) (F) (G) (H) | 111 (A) (B) (C) (D) |
| 73 (A) (B) (C) (D) | 86 (E) (F) (G) (H) | 99 (A) (B) (C) (D) | 112 (E) (F) (G) (H) |
| 74 (E) (F) (G) (H) | 87 (A) (B) (C) (D) | 100 (E) (F) (G) (H) | 113 (A) (B) (C) (D) |
| 75 (A) (B) (C) (D) | 88 (E) (F) (G) (H) | 101 (A) (B) (C) (D) | 114 (E) (F) (G) (H) |

